

# Panasonic

Integrated Telephone System  
with Single Micro Cassette  
*Easa-Phone*

UNITED  
KINGDOM  
MODEL NO.

# KX-T2396BE

## OPERATING INSTRUCTIONS



Please read before use.

# AUTO-LOGIC

# Important Information

Do not connect the AC adaptor to any AC outlet other than the standard AC 240 V, 50 Hz.

- The power supply unit complies with BS6301: 1982.
- Outlet voltage DC 13.5 V, DC 400 mA
- The apparatus is approved for use with the KX-A11BE power supply.

**APPROVED** for connection to telecommunication systems specified in the instructions for use subject to the conditions set out in them.

S/1016/3/M/502158

## Ringer Equivalence Number (REN):

This relates to the performance of the apparatus when used in combination with other items of apparatus. It enables the calculation of the maximum number of items of apparatus that may be connected simultaneously to the line by summing the REN values of each item. A B.T. supplied instrument has a REN value of 1 unless otherwise marked. A maximum REN value of 4 should not be exceeded. The REN value of this apparatus is 1.

## Method of connection

This is connected to the exchange line or PABX/PMBX (Private Automatic/Manual Branch Exchange) extension by the new standard British Telecom plug and socket. Arrangements for provision of this type of termination can be made through the nearest British Telecom Sales Office.

The apparatus may be connected to the following types of installation. The apparatus has been approved for use under the following conditions:

- a) For connection to the public switched telephone network (PSTN) and compatible (Private Branch Exchange), which use LD signalling and MF signalling. (Please consult your supplier for an up to date list of compatible PBX's.)
- b) The apparatus can be used on extension sockets connected to a direct exchange line (D.E.L).
- c) This apparatus is suitable for connection to the telecommunication system directly or via compatible private branch exchange as an extension. The supplier of the apparatus should be consulted for an up to date list of PBX's with which the apparatus is compatible.
- d) This apparatus must not be connected in the following manner:
  - 1) As an extension to a pay phone
  - 2) As a party line with shared service
  - 3) As part of 1+1 carrier systems

It cannot be guaranteed that the apparatus will operate under all possible conditions of connection to compatible PBX's.

- This apparatus is suitable for connection to a PBX with or without initial proceed indication.
- This apparatus is suitable for connection to a PBX with or without secondary proceed indication.

This apparatus has been approved for the use of the following facilities:

- 1) Loud speaking facility
- 2) Storage of telephone numbers by direct call buttons
- 3) Automatic Dialling
- 4) Automatic storage of last number dialled
- 5) Repeat Attempt: Single
- 6) Simple telephone facility
- 7) PBX earth register recall  
PBX timed break register recall
- 8) MF Signalling
- 9) LD Signalling
- 10) On-hook dialling
- 11) Mercury dialling compatibility
- 12) Hold function
- 13) Pause
- 14) 3-step ringer volume selector:  
HIGH/LOW/OFF
- 15) Answering & Recording Machine
- 16) Recording and playback of ICM
- 17) DTMF tone remote control system
- 18) Memo recording feature
- 19) Monitoring a telephone call
- 20) LED Call-Counter: to indicate received messages
- 21) Vox facility: detection of caller's hanging up
- 22) 2-step ring selector: AUTO/LONG
- 23) 2-way recording
- 24) Auto disconnect
- 25) Caller's recording time 2 minutes  
20 seconds
- 26) Security code for remote operation

Any other usage will invalidate the approval of the apparatus if as a result, it then ceases to conform the standards against which approval was granted.

Any cases of difficulty should be referred in the first instance to the supplier of the apparatus.

999 can be dialled on the apparatus for the purposes of making outgoing calls to the B.T. Emergency (999) Service.

**CAUTION:**

Do not remove cover. Live parts inside.

**NOTE:**

If you experience any problems with the normal use of your apparatus, you should unplug it from the telephone outlet and connect a known working telephone in its place. If the known working telephone still gives problems, then call British Telecom Engineers. If it operates properly, then the problems are likely to be a fault in your apparatus. In this case, contact your supplier for advice. British Telecom will charge you if they attend a service call that is not due to apparatus supplied by them.

Interconnection directly, or by way of other apparatus, of ports marked "SAFETY WARNING. See instructions for use." with ports marked or not so marked may produce hazardous conditions on the network and advice should be obtained from a competent engineer before such a connection is made.

# Table of contents

Important information .....	1~2
Table of contents .....	3~4
Location of controls .....	5~8
Enclosures .....	9
Inserting the tape .....	10
Connection .....	11~12
Initial preparation .....	13~17
Selector settings .....	13~14
Recording an Outgoing Message .....	15~16
Checking your recorded OGM .....	17
Using your answering machine .....	17

## **TELEPHONE**

Making and answering calls .....	19~20
Making calls with the handset .....	19
Making calls with the MONITOR button (on-hook dialling) .....	19
Redialling .....	20
Answering calls .....	20
Automatic Dialling .....	21~22
Making calls using the upper memory location .....	21
Making calls using the lower memory location .....	22
Storing the telephone numbers .....	23~26
Storing into the upper memory location .....	24
Storing into the lower memory location .....	25
Correcting an error while storing .....	26
Confirming a stored number .....	26
Erasing a stored number .....	26

For Mercury dialling .....	27~29
Programming for Mercury code .....	27
Dialling using the Mercury network .....	28
Confirming the memory .....	28
Resetting the Mercury station's memory .....	29
Other operation .....	30~31
Recall .....	30
Hold, Tone, Pause, Combination dialling .....	31

## **ANSWERING MACHINE**

Setting up for answering machine .....	33~34
Recording from the beginning of the ICM part of the tape .....	34
Recording after the messages you have heard .....	34
Listening to the recorded messages .....	35~36
Playing back the tape from the beginning .....	36
Remote operation .....	37~39
Remote code number .....	37
Playing back all the messages .....	38
Resetting the tape for future message .....	39
Recording a marker message .....	39
Setting the answer mode remotely .....	39
Recording a memo message .....	40
Recording a conversation (2-way recording) .....	41
Monitoring the incoming calls .....	42
Troubleshooting guide .....	43~44
Wall mounting .....	45
Maintenance .....	46~47
Others .....	48
QUICK REFERENCE CARD for tone remote control can be found on this page.	
GUARANTEE .....	50

# Location of controls

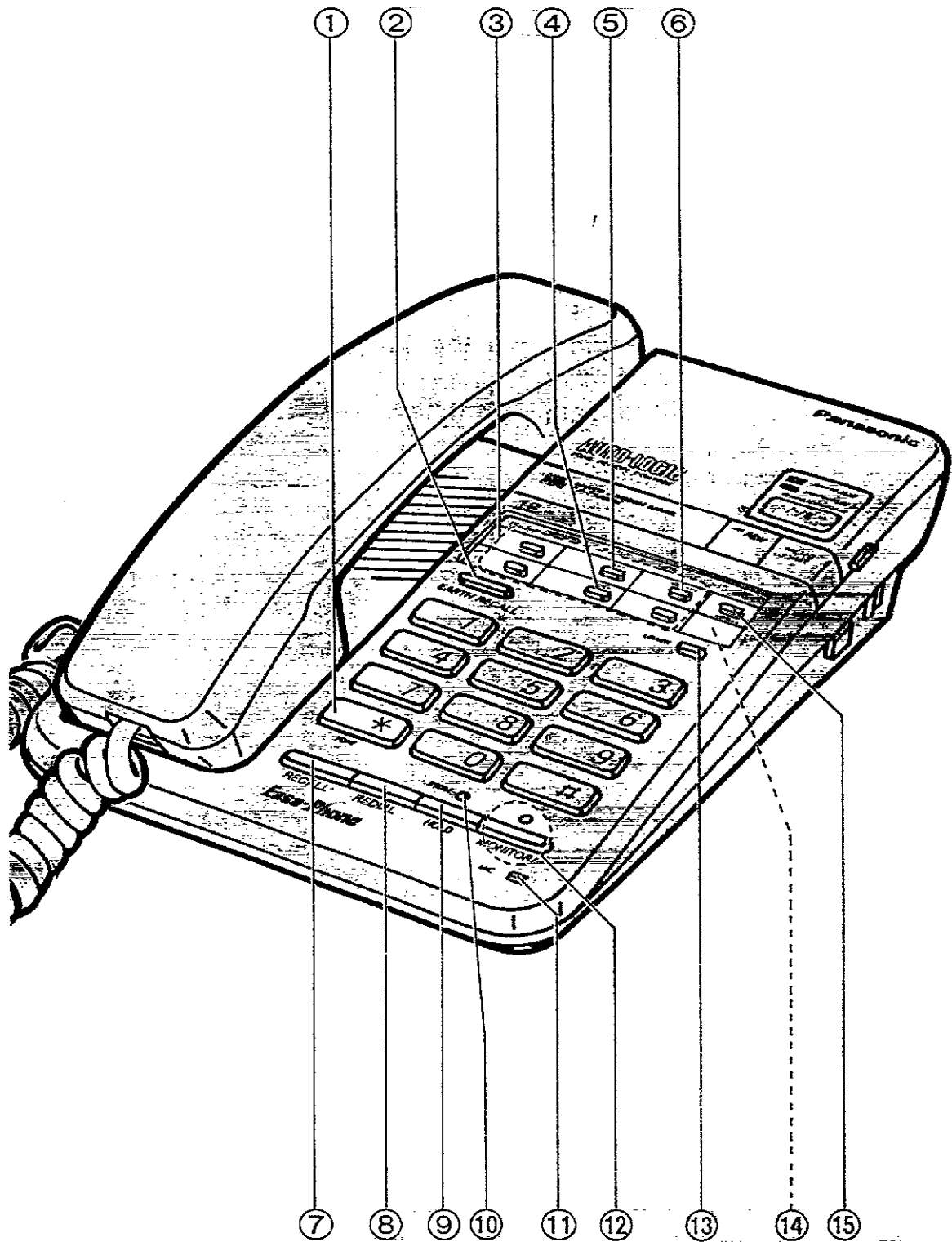

- ① **TONE Button** (page 31):  
Used to change the dialling mode from pulse to tone during a dialling operation.
- ② **EARTH RECALL Button** (page 30):  
Used to access some feature of your host PBX which has earth recall facility.
- ③ **Direct Call Buttons** (page 21):  
Used to store phone numbers and to make calls using one touch dialling.
- ④ **CLEAR Button** (page 26):  
Used to clear the memory while storing telephone number.
- ⑤ **PAUSE Button** (page 31):  
Used to enter a pause in phone numbers when programming.
- ⑥ **MERCURY Button** (page 27):  
Used to store Mercury access number and authorization code and to make calls using Mercury network.
- ⑦ **RECALL (Timed Break Recall) Button** (page 30):  
Used to access some of the feature of your host PBX which has timed break register recall facility.
- ⑧ **REDIAL Button** (page 20):  
Used to redial the last dialled phone number.
- ⑨ **HOLD Button** (page 31):  
Used to put the calling party on hold during a conversation. It serves as a store button when programming phone numbers.
- ⑩ **STORE (HOLD) Indicator** (page 24):  
It lights or flashes when programming. It also flashes when holding a call.
- ⑪ **MIC (Microphone)** (page 16)
- ⑫ **MONITOR Button and Indicator** (page 19):  
Used to dial a phone number or monitor the caller's voice while having conversation without using the handset.
- ⑬ **LOWER Button** (page 22):  
Used to select the lower memory location.
- ⑭ **RESET Button** (page 29):  
Used to reset the programmed Mercury memory. It is located under the memory card.
- ⑮ **PROG (Program) Button** (page 24):  
Used to start and complete the programming procedure.

# Location of controls

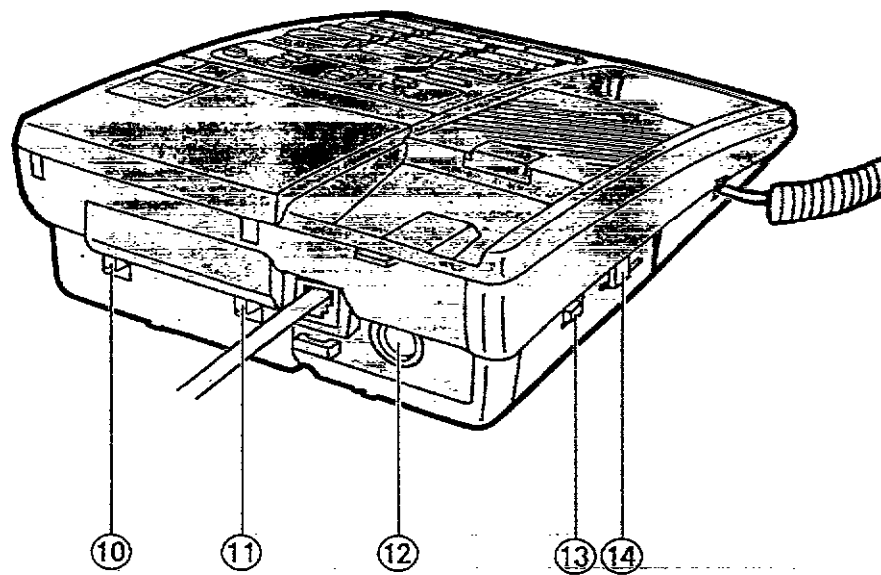
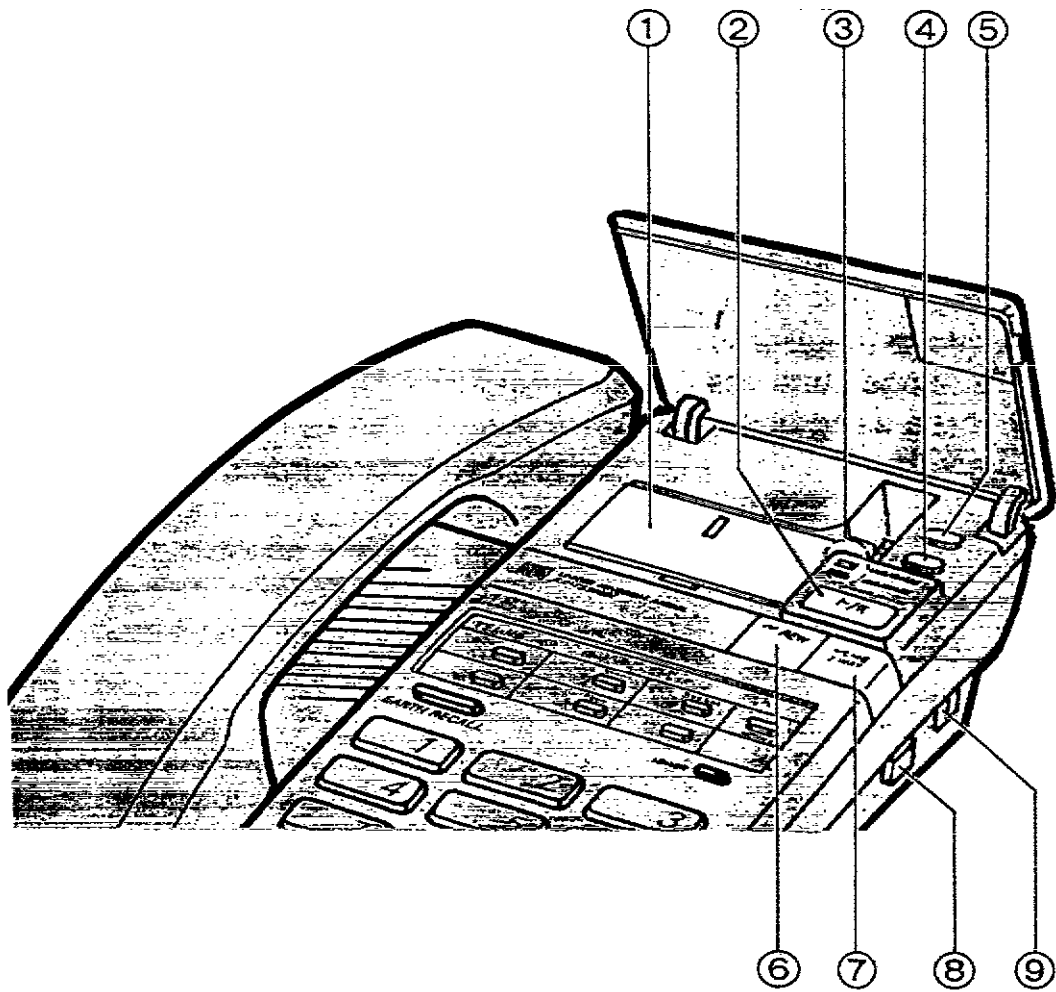



- ① Cassette cover (page 10)
- ② PLAYBACK/PAUSE Button (page 34):  
Used to play back the recorded Incoming Messages and to stop the ICM tape temporarily during ICM playback.
- ③ PWR/IN USE (Power/In use) Indicator (page 34):  
It lights when the unit is powered on, and it flashes while recording message.
- ANS/CALLS (Answer/Calls) Indicator (page 34):  
It lights when the unit is ready to answer the calls, and it flashes indicating the number of recorded messages after the message was recorded.
- ④ OGM PLAY Button (page 17):  
Used to play the recorded Outgoing Message.
- ⑤ OGM REC Button (page 16):  
Used to record the Outgoing Message.
- ⑥ REW (Rewind) Button (page 34):  
Used to rewind the cassette tape.
- ⑦ MEMO/2 WAY Button (page 40):  
Used to record a memo message or a telephone conversation.
- ⑧ ANS SYS (Answer System) ON/OFF Switch (page 14):  
Used to turn on and off the unit. The PWR/IN USE indicator light when the unit is turned on.
- ⑨ DIALING MODE Selector (page 14):  
Used to change the dialling mode TONE or PULSE.
- ⑩ RINGS (Ring times) Selector (page 14):  
Used to select the number of rings that it takes for the unit to answer.
- ⑪ VOX SENS (Sensitivity) Selector (page 14)
- ⑫ DC IN Jack (page 14)
- ⑬ RINGER (Ringer volume) Selector (page 14):  
Used to select the ringer volume HIGH, LOW or OFF.
- ⑭ VOLUME Control (page 42):  
Used to adjust the sound level for the built-in-speaker.

# Enclosures

AC adaptor ..... one  
KX-A11BE

Screw ..... two

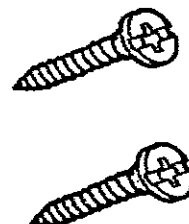
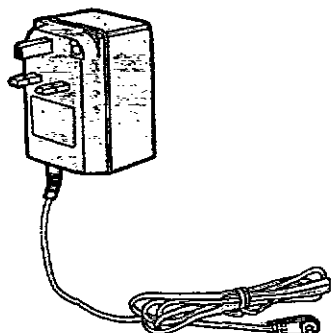

Microcassette tape ..... one

Washer ..... two

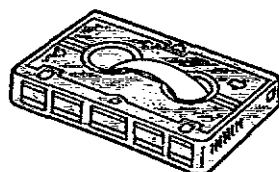

Wall mounting adaptor ..... one

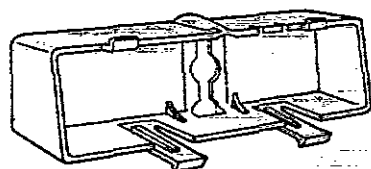

# Inserting the tape

Cassette tape compartment is covered. When you change the tape, remove the cassette cover as shown below.

1



Open the cassette panel.

2

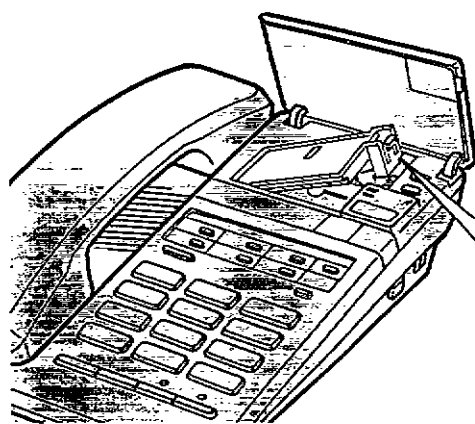

Remove the cassette cover using the instrument with the pointed end like a pen.

**WARNING: UNPLUG THE CONNECTION TO THE B.T. NETWORK BEFORE OPENING THE CASSETTE COVER.**

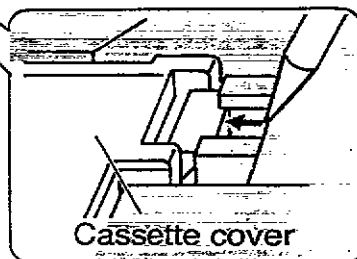

Cassette cover

3

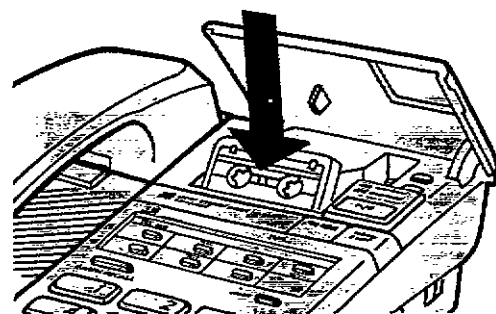

Insert the cassette tape.

4

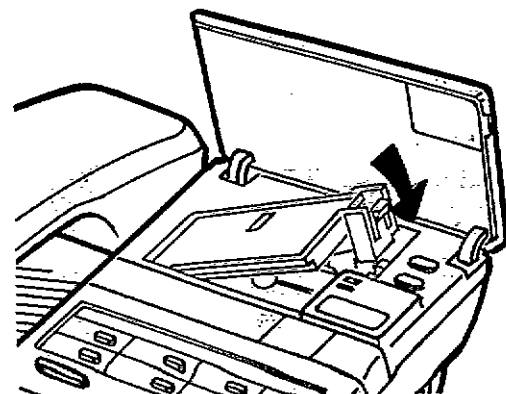

Place the cassette cover.

# Connection

This unit is designed to be connected as shown.

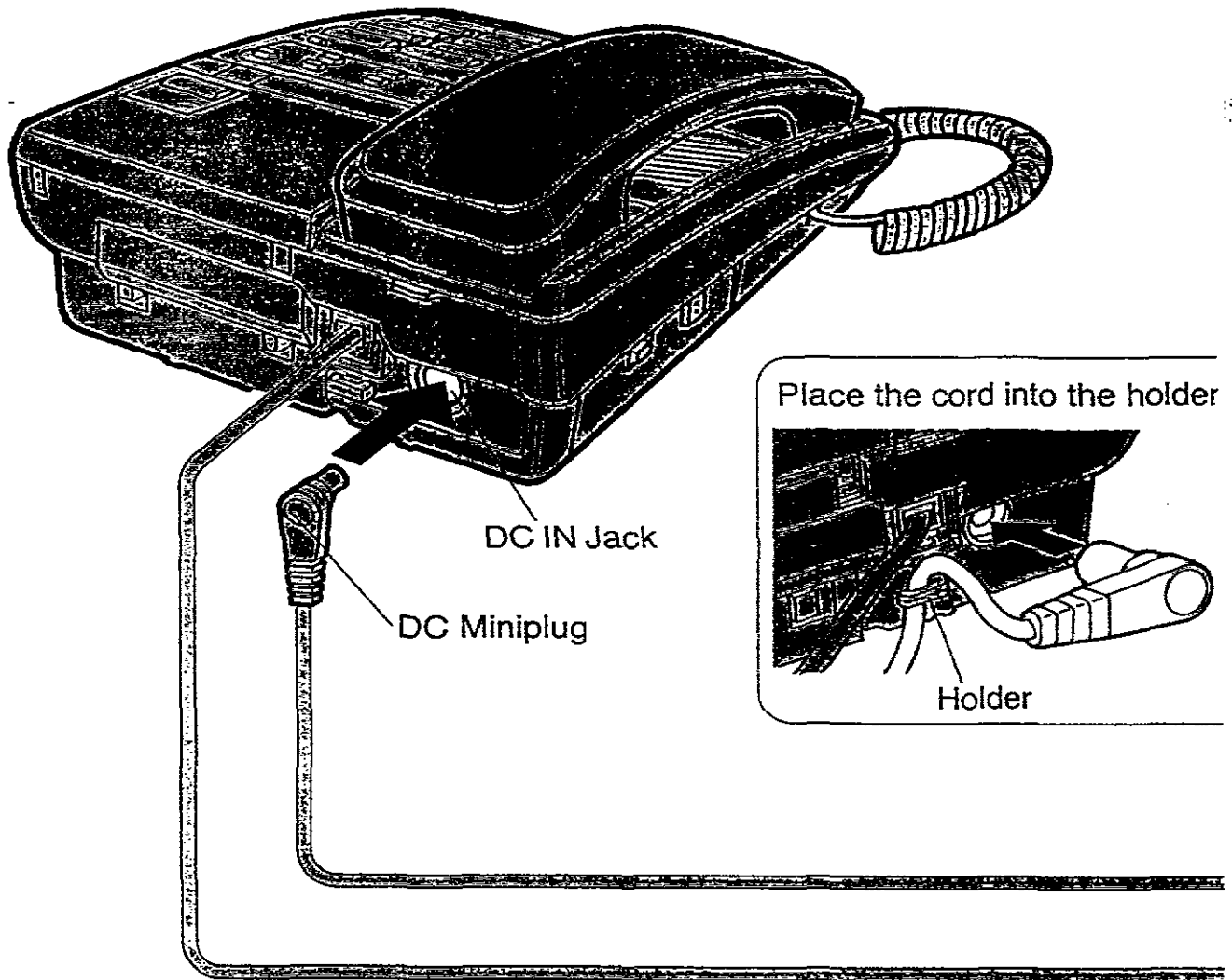

## WARNING

Identified ports do not provide isolation sufficient to satisfy the requirements of BS 6301. Apparatus connected to such ports should either have been approved to BS 6301 or have previously been evaluated against British Telecommunications plc (Post Office) Technical Guides 2 or 26 and given permission to attach. Other usage will invalidate any approval given to the apparatus.

## CONNECTION OF POWER SUPPLY

This apparatus is intended for use when powered by KX-A11BE. Other usage will invalidate any approval given to this apparatus if as a result it ceases to comply with the edition of BS 6301 to which it was approved.

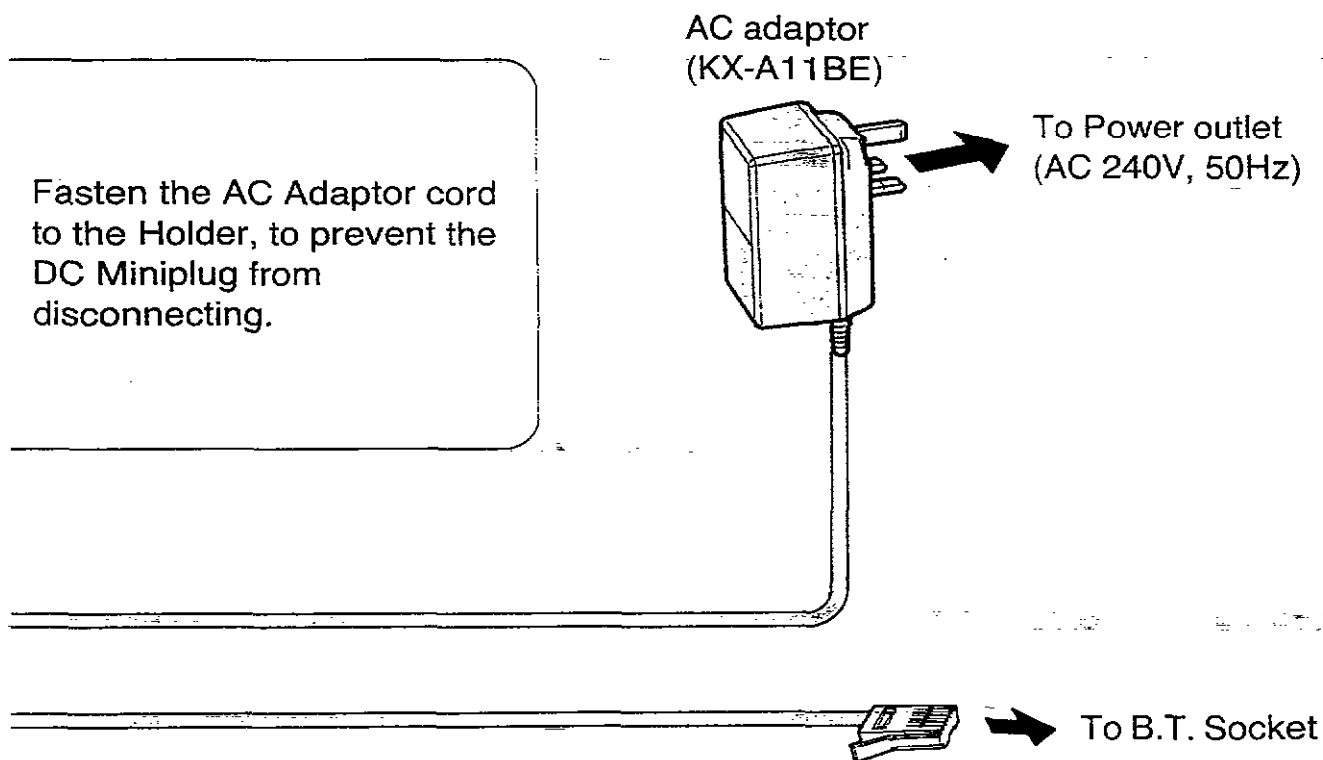

- Be sure to insert the tape before connecting the AC adaptor.
- If a power failure takes place, the unit can be used as a typical telephone.
- Be sure to use the included AC adaptor Panasonic Model KX-A11BE.
- While you are operating the unit, the case of the AC adaptor may feel warm. This is a normal condition.

# Initial preparation

## Selector settings

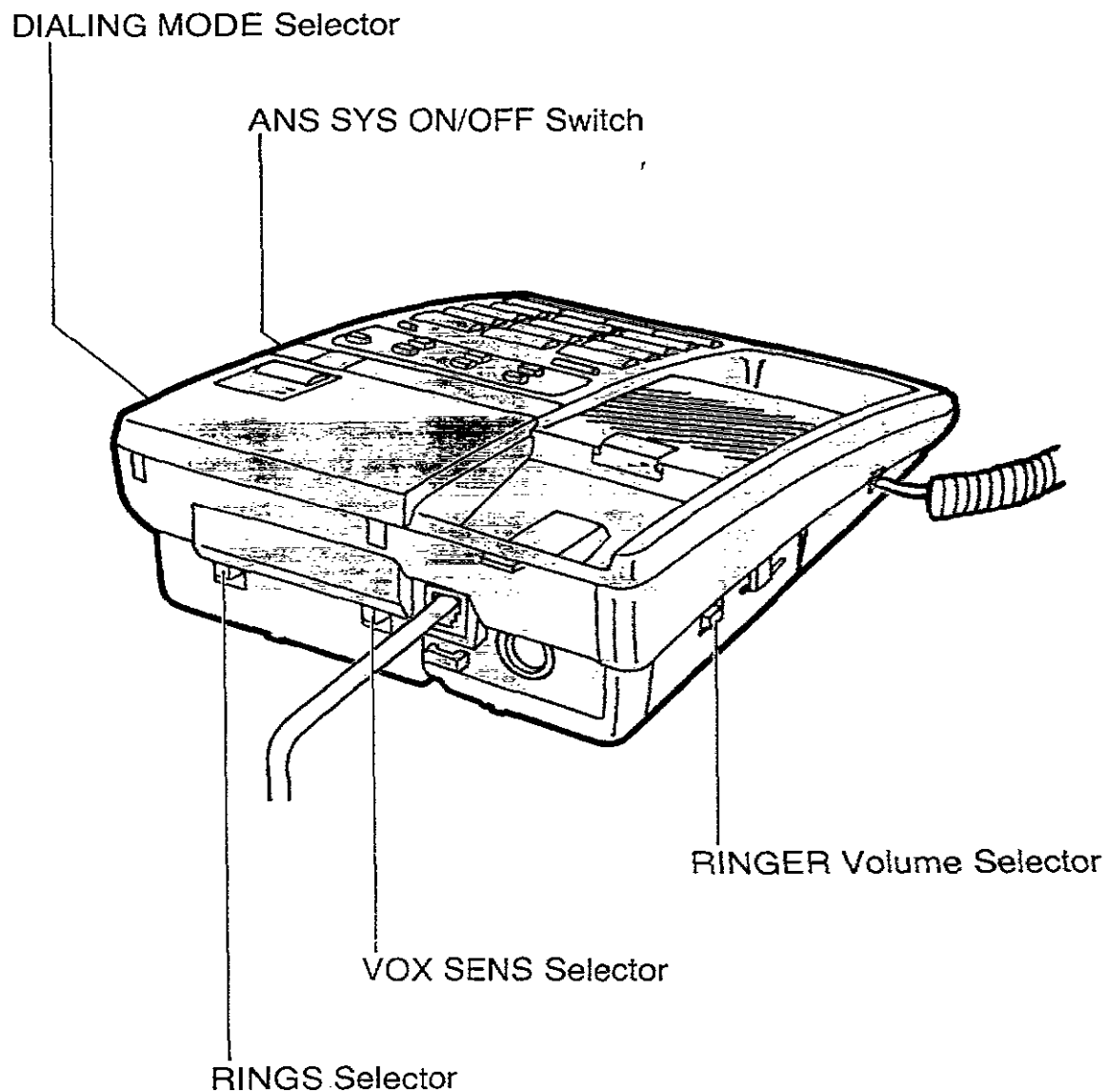

## Function of the AUTO setting (TOLL SAVER)

When you call the unit from an outside phone, the number of rings that it takes for the unit to answer tells you if there are any new messages.

If the unit answers on the 2nd ring: There is at least one new message.

If the unit answers on the 4th ring: There are no new messages.

Hang up immediately when you hear the 3rd ring. Because the 3rd ring indicates there are no new messages. This will save you the toll charge for the call.

1

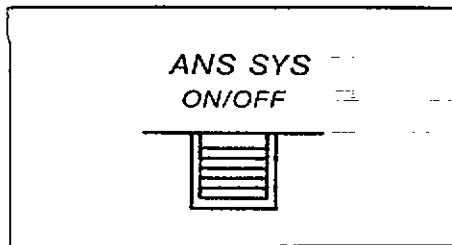

### ANS SYS ON/OFF Switch

Press the switch to turn on the unit. The PWR/IN USE indicator light is on, and the unit reset the cassette tape.

2

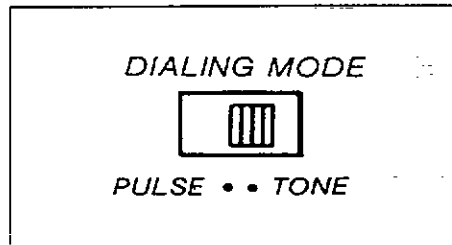

### DIALING MODE Selector

Set the selector to the "TONE" position if your telephone line has touch tone service. If it has rotary service, set to the "PULSE" position.

3

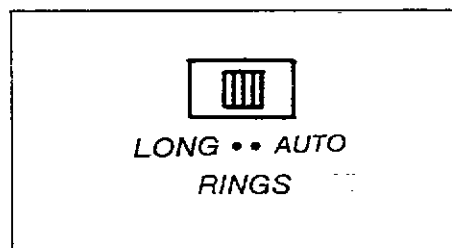

### RINGS Selector

**LONG:** When the unit is used on an extension of PMBX which uses manual ringing, set to the "LONG" position. The unit will answer on the first ring.

**AUTO:** See "TOLL SAVER" on page 13.

4

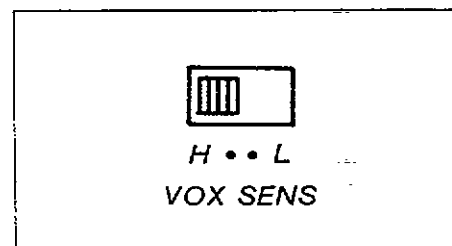

### VOX SENS Selector

If either the tape continues to run after a caller has replaced his handset or there are long pauses between or after messages, set the selector to the position "L" (Normally the switch is preset to the position "H".)

5

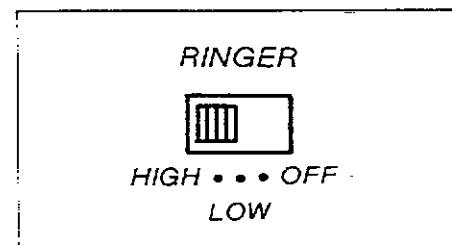

### RINGER Volume Selector

Set the selector to the "HIGH" or "LOW" position. When setting to the "OFF" position, the unit does not ring.

## Recording an Outgoing Message (OGM)

The Outgoing Message is an announcement to tell the caller that you are out, and asks to leave a message.

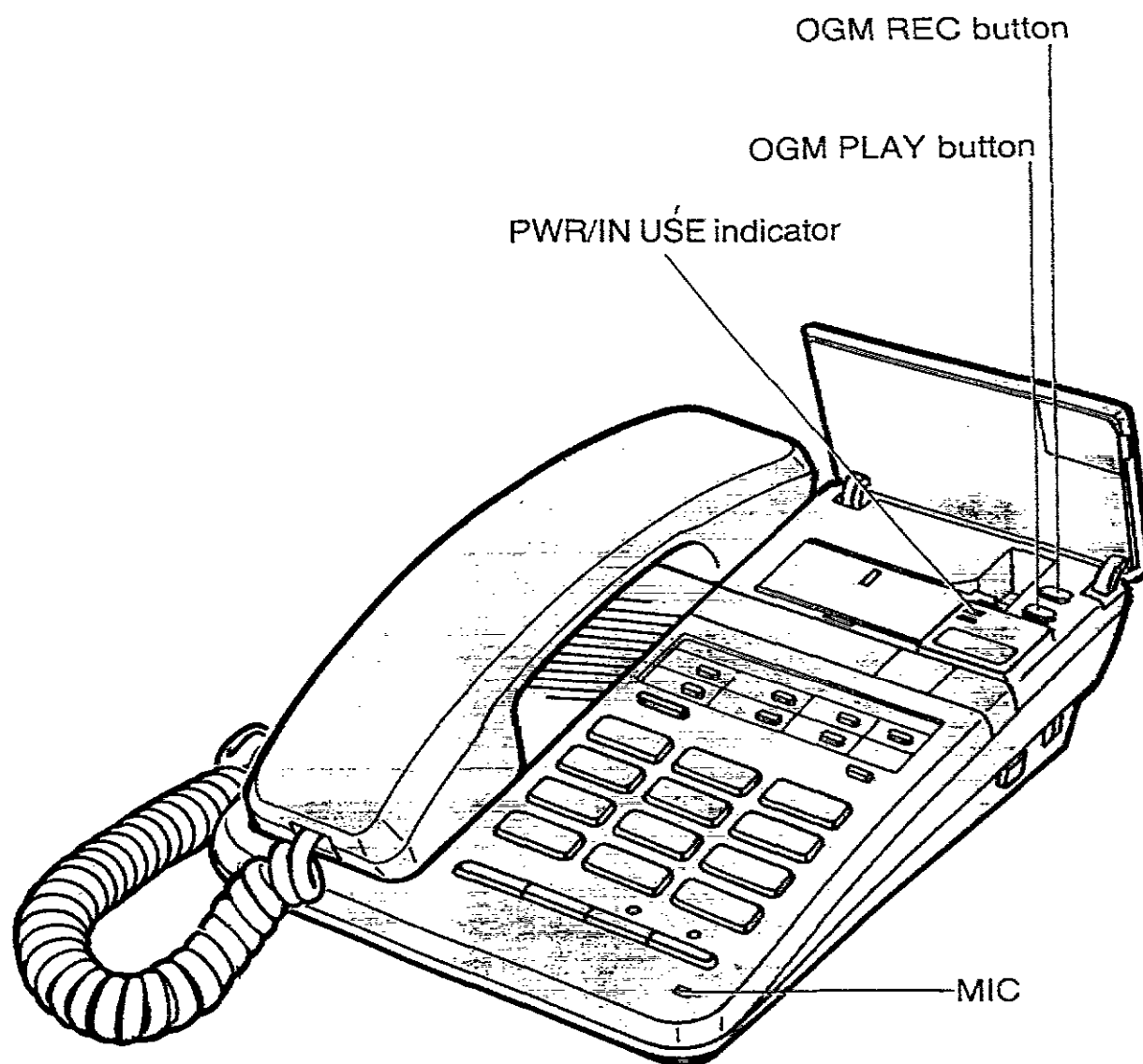

### Sample OGM

- Please record the bold-faced sentence surely on the OGM.
- Caller's recording time is up to 2 minutes 20 seconds.
- A series of short beeps lasts while the tape is preparing for recording, and a long beep means the tape is ready.

"Hello, this is Dick Smith. I'm out now, but if you leave a message I'll call you back. **You will hear a series of short beeps then a long beep will be heard certainly. Speak after the long beep. You have 2 minutes 20 seconds.**"



Confirm that the PWR/IN USE indicator light is on.  
Your OGM can be up to approximately 30 seconds long.

**CAUTION:**

Do not pause for over 2 seconds during recording.  
If 6 beeps sound, start over from step 1 again after the unit stops  
rewinding.

1

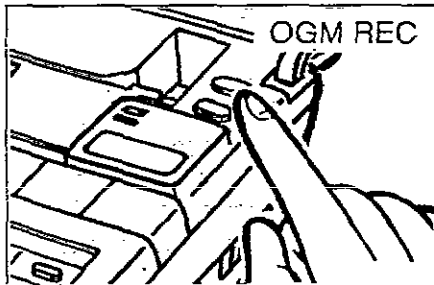

Press the OGM REC button, then  
release it.

A series of short beeps will be  
heard followed by a long beep.

*is heard.*

2



Immediately after the long beep,  
speak clearly and loudly, about  
20 cm away from the microphone.

The PWR/IN USE indicator flashes.

3

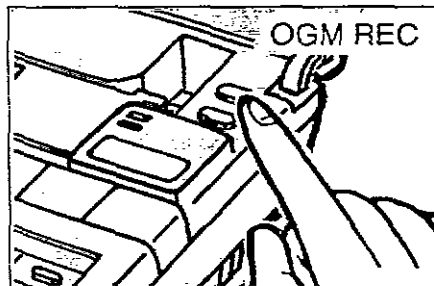

Press the OGM REC button again  
when you finish recording.

The unit rewinds the tape, and will  
be ready to answer the calls after  
10 seconds.

**NOTE:**

When there is no room left on the tape to continue recording the caller's  
message, a beep will sound 6 times after the OGM or during the callers'  
recording. If you want to inform this to the caller, please record next  
sentences additionally in your outgoing message.

**"If the beep sounds 6 times, your message will not be recorded.  
Should this happen, please call back tomorrow."**

## Checking your recorded OGM

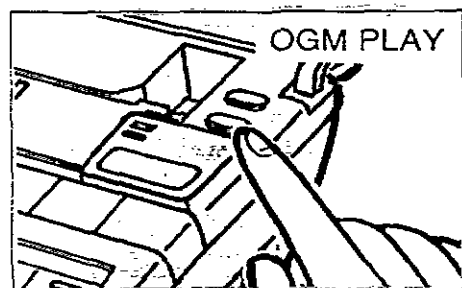

Press the OGM PLAY button.

Press the OGM PLAY button again if you want to stop the operation halfway.

The unit will be ready to answer the calls after 10 seconds.

## Using your answering machine

After having done all the preparations for this unit (including connection), the unit resets the tape, and 10 seconds later, the ANS/CALLS indicator light is on.

Now your unit is ready to answer the phone call.

(The unit is set to the answer mode.)

Then it will record the callers' Messages.

# TELEPHONE



# Making and answering calls

## Making calls with the handset

1. Lift the handset, and identify the dial tone.
2. Dial the telephone number.

## Making calls with the MONITOR button (on-hook dialling)

1

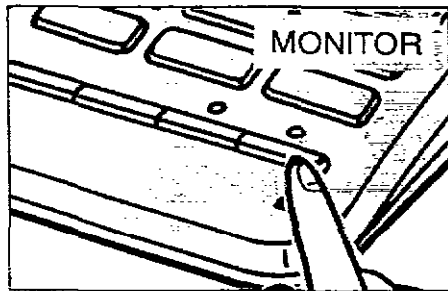

Press the MONITOR button, and identify the dial tone.

The MONITOR indicator light is on.

2

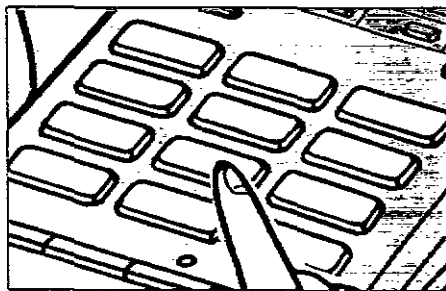

Dial the telephone number.

3



When the other party answers, lift the handset and speak to the other party.

Hang up the handset when your conversation is over.  
The MONITOR indicator light is off.

## Redialling

The unit can redial the last dialled number automatically. The REDIAL button will store the last dialled number into memory up to 32 digits.

1

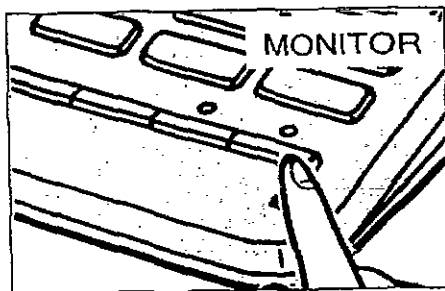

Lift the handset or press the MONITOR button, and identify the dial tone.

2

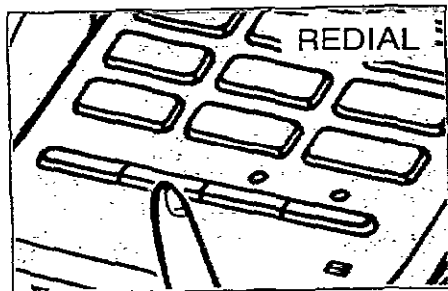

Press the REDIAL button.

You can redial once.

You can redial soon after dialling the telephone number by pressing the REDIAL button without hanging up.

## Answering calls

When the telephone rings, lift the handset and start speaking.

# Automatic dialling

There are 6 direct call buttons including CLEAR, PAUSE and MERCURY. Each button consists of 2 memory locations (upper and lower) except the MERCURY button. Only the lower station is available when storing a telephone number into the MERCURY button. You can store 11 numbers up to 32 digits.

## CAUTION:

Do not press any direct call buttons before storing the telephone number. This is to prevent misoperation of automatic dialling function. Refer to "Storing the telephone numbers" on pages 23 to 26.

## Making calls using the upper memory location

1

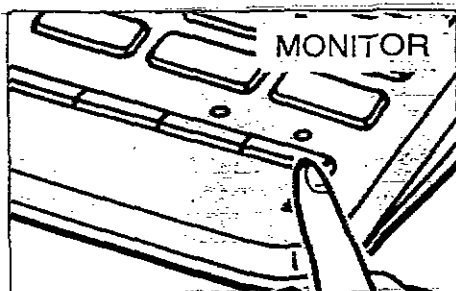

Lift the handset or press the MONITOR button, and identify the dial tone.

2

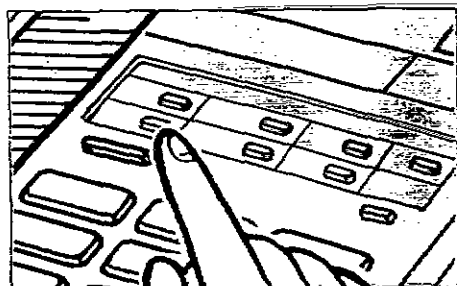

Press the direct call button except the MERCURY button in which the number that you want to dial is stored.

# Making calls using the lower memory location

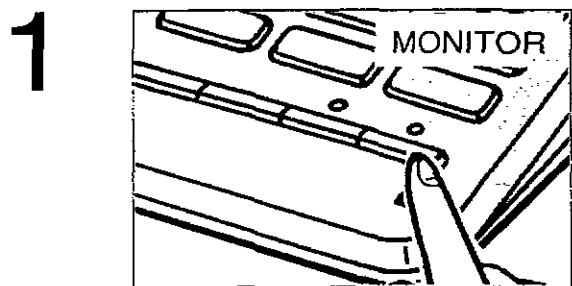

Lift the handset or press the MONITOR button, then identify the dial tone.

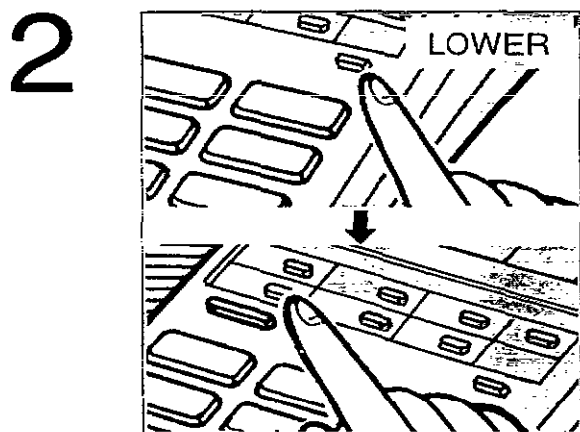

Press the LOWER button, then press the direct call button in which the number that you want to dial is stored.

If you press the LOWER button by mistake when you want to use the upper location, you must hang up and then dial again.

## Memory card

Use a pencil or a ball-point pen to fill in the station directory with station name. (You can use the reverse side for writing, too)

Remove the cover using an instrument with a pointed end, like a pen.

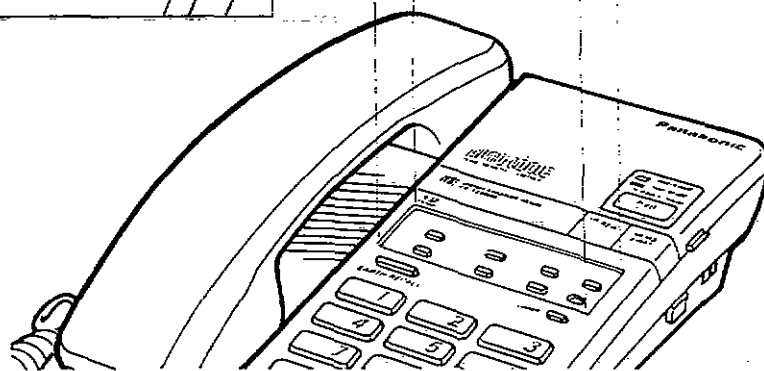
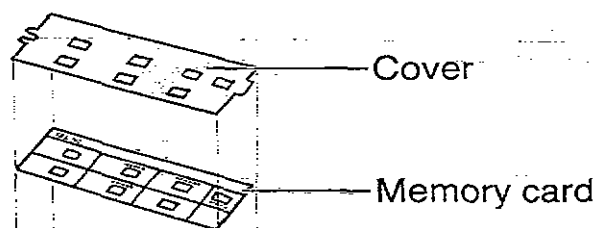
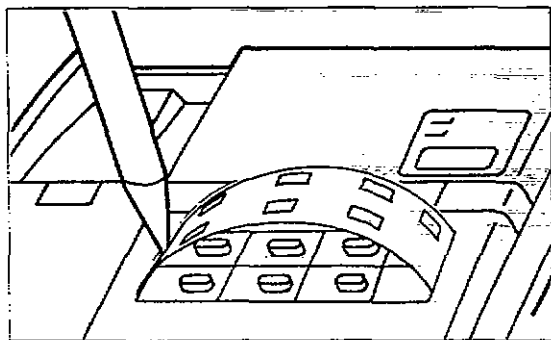

# Storing the telephone numbers

Make sure that the handset is on the cradle, the MONITOR indicator is off and the AC adaptor is connected. When you store a telephone number into memory, pressing 0 through 9, #, \*, PAUSE, or RECALL button counts as 1 digit.

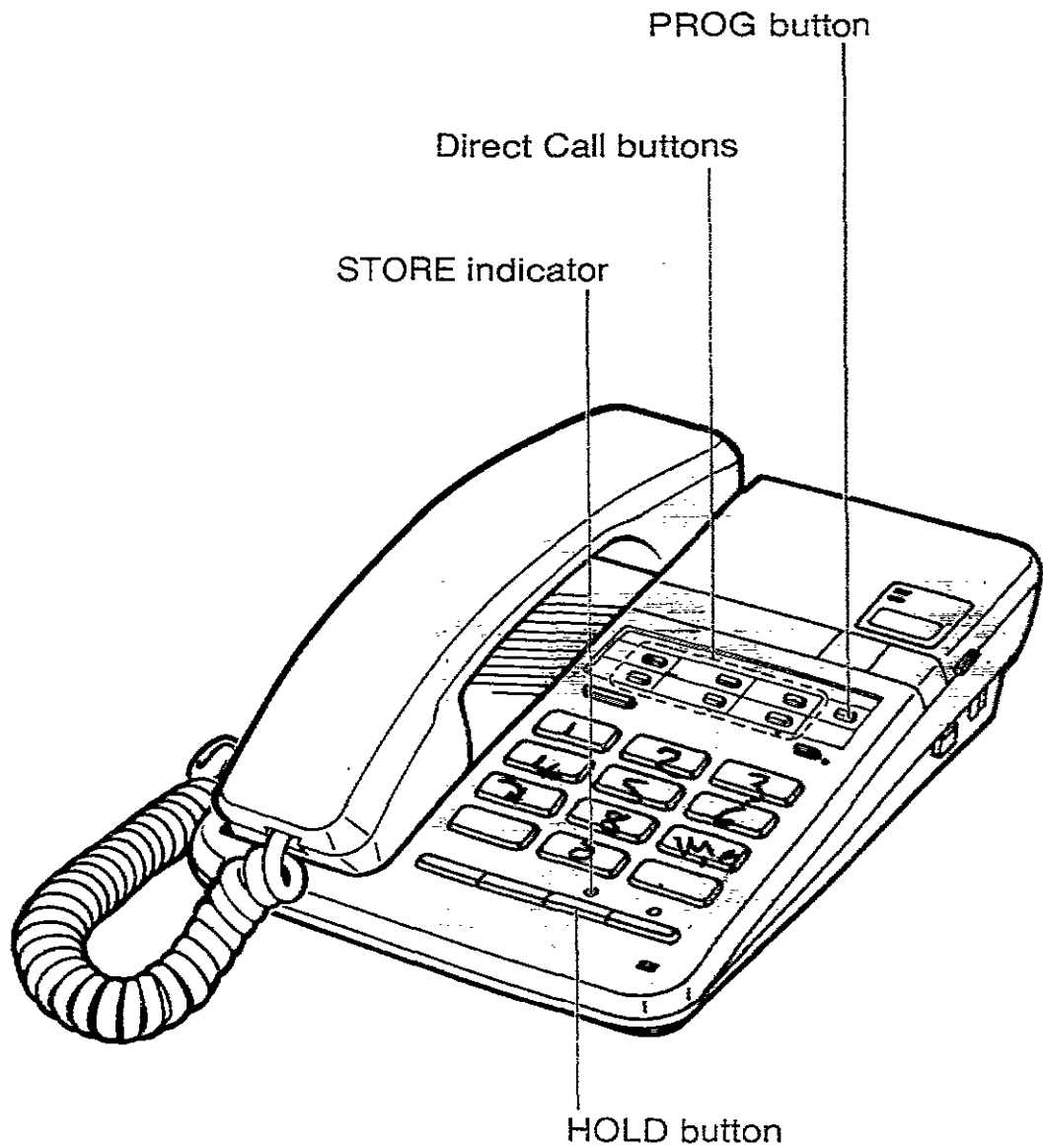



## Storing into the upper memory location

1

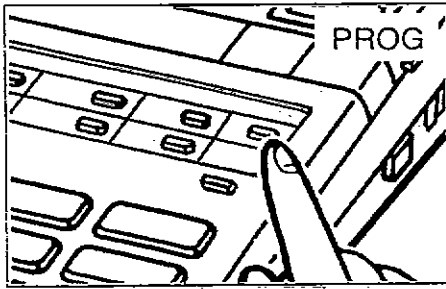

Press the PROG button.

The STORE indicator light is on.

2

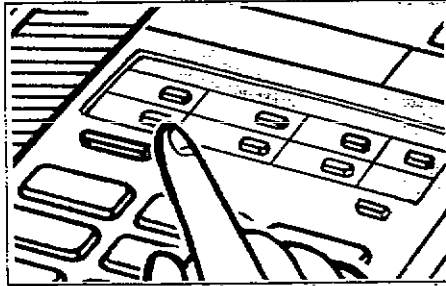

Press the direct call button except the MERCURY button.

The STORE indicator light goes out.

3

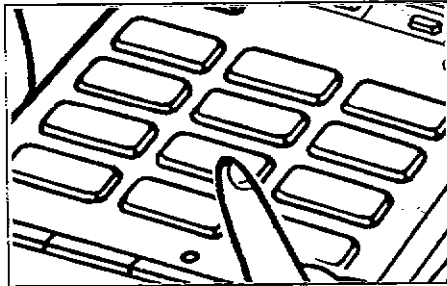

Dial the telephone number that you want to store, up to 32 digits.

4

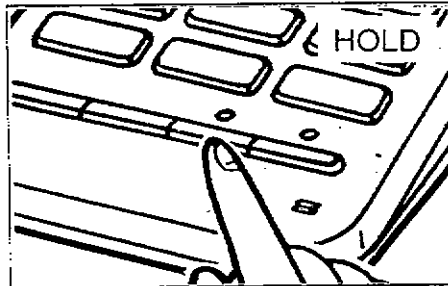

Press the HOLD button to store the number into memory.

The STORE indicator light is on. To store other numbers in succession, repeat from step 2.

5

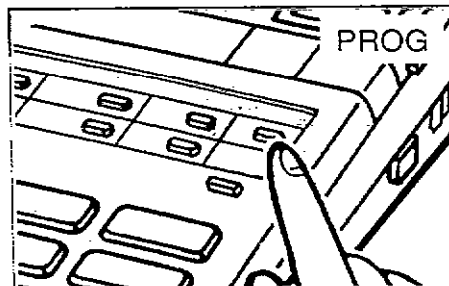

Press the PROG button after storing all the numbers.

The STORE indicator light goes out.

## Storing into the lower memory location

1

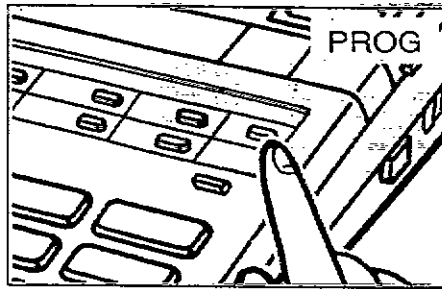

Press the PROG button.

The STORE indicator light is on.

2

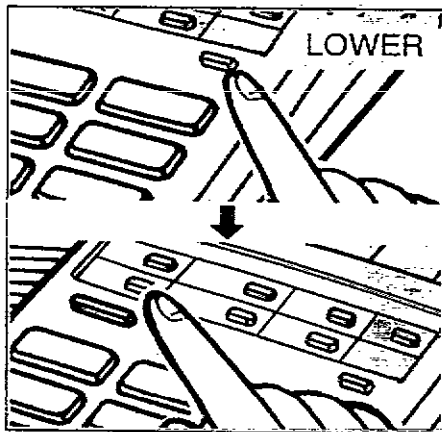

Press the LOWER button (the STORE indicator flashes), then press the direct call button.

The STORE indicator light goes out.

3

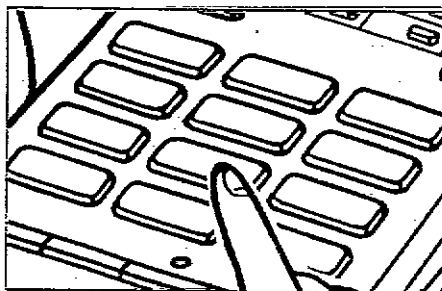

Dial the telephone number that you want to store, up to 32 digits.

4

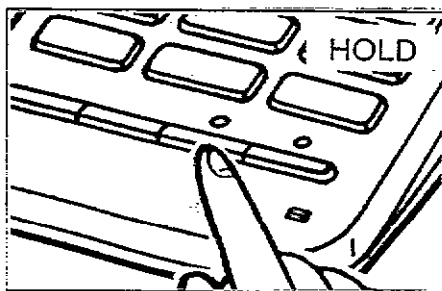

Press the HOLD button.

The STORE indicator light is on. To store other numbers in succession, repeat from step 2.

5

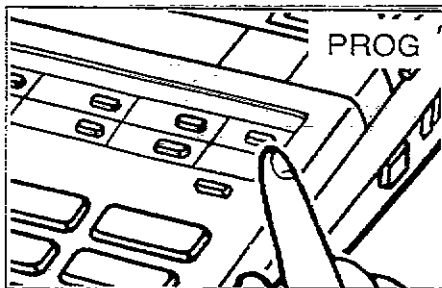

Press the PROG button after storing all the numbers.

The STORE indicator light goes out.

## Correcting an error while storing

If you notice an error before pressing the HOLD button;

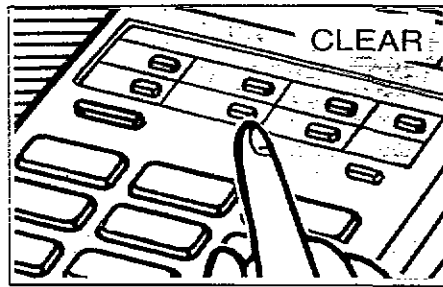

Press the CLEAR button.

Repeat from step 2 of the storing procedure.

## Confirming a stored number

Store the same number into the same station. When you press the HOLD button, you hear a beep once or twice.

- Twice: The number newly stored is the same as that was previously stored.
- Once: The number newly stored is different from the one that was previously stored. Reprogram the correct number.

## Erasing a stored number

1. Press the PROG button.
2. Press the direct call button in which the number that you want to erase is stored.
3. Press the HOLD button.
4. Press the PROG button.

When you want to erase the number stored into the lower memory location, press the LOWER button then press the direct call button at step 2 of the above procedure.

# For Mercury dialling

This unit is compatible with the Mercury Telephone Network. Before using Mercury Network feature, store the Mercury access number and authorization code into the MERCURY button (upper memory location).

## Programming for Mercury code

1

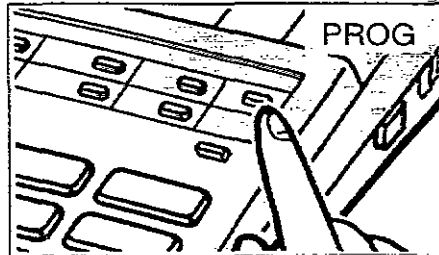

Press the PROG button.

2

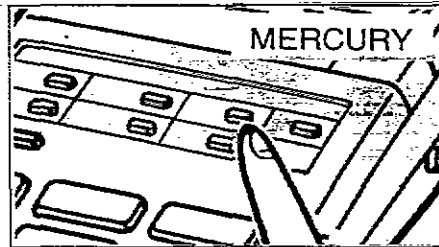

Press the MERCURY button.

3

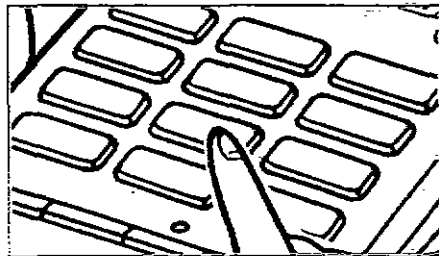

Dial the Mercury access number and authorization code up to 32 digits.

When you make a mistake during programming, clear the memory (See page 29.), then reprogram it.

4

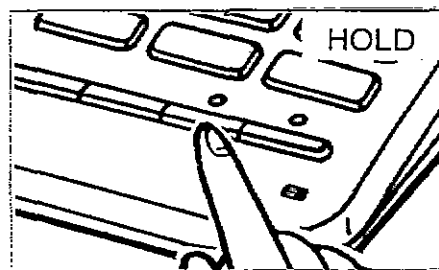

Press the HOLD button.

5

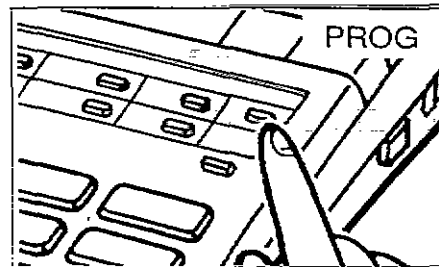

Press the PROG button.

## Dialling using the Mercury network

1

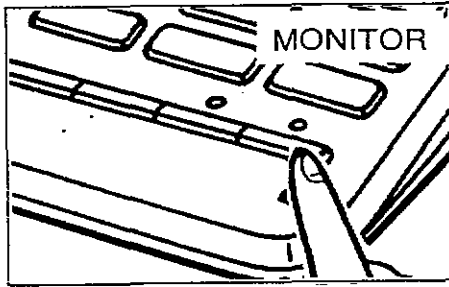

Lift the handset or press the MONITOR button.

2

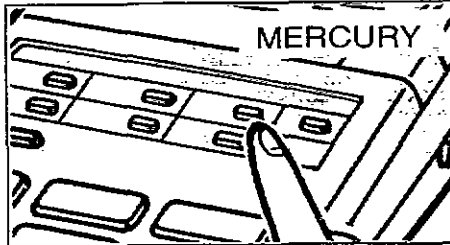

Press the MERCURY button.

High pitch tone will be heard during dialling.

3

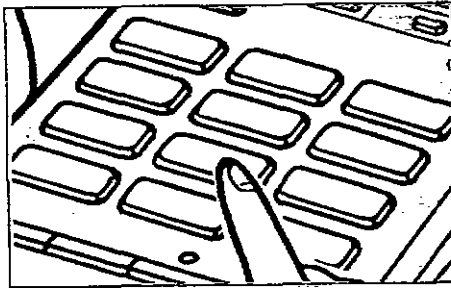

Dial the telephone number that you want to call using the dialling keypads, or press the direct call button in which the number that you want to call is stored.

## Confirming the memory

Store the Mercury access number and authorization code again into the MERCURY station. When the HOLD button is pressed, you hear a beep once, twice or six times for confirmation.

**Twice:** The code number newly stored is the same as that was previously stored.

**Once:** No code number is stored beforehand and the number is stored into memory.

**Six times:** The code number newly stored is different from the one that was previously stored. If you want to store the new code number, reset the MERCURY station's memory, then reprogram it (for resetting the memory, see page 29).

## Resetting the Mercury station's memory

When you want to change your Mercury code to a new code, clear your old memory using the RESET button.

The RESET button is located under your memory card. Remove the cover and memory card.

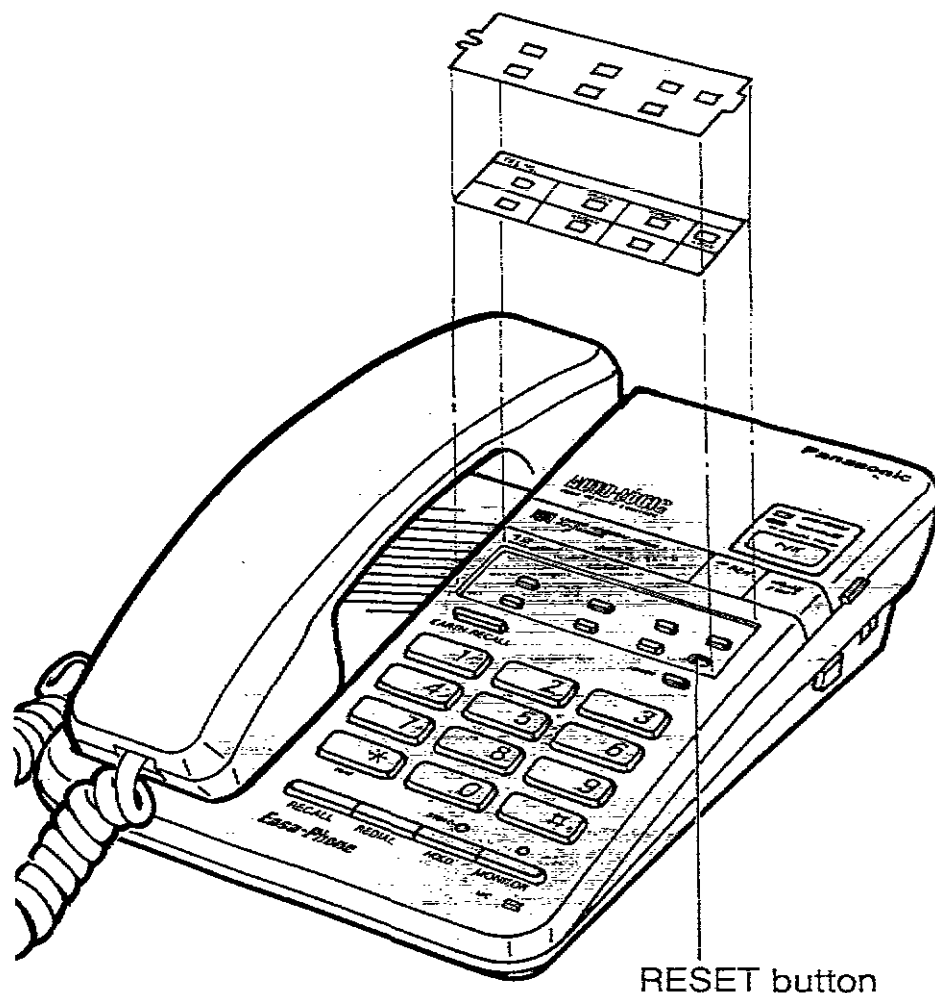

### To reset

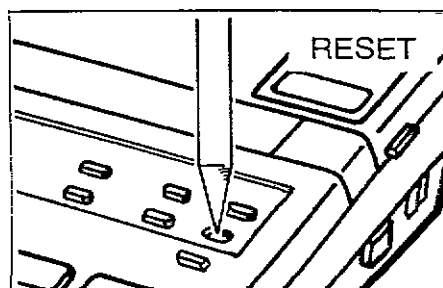

Press the RESET button to clear the programmed code using a pointed object such as a ball point pen.

The stored Mercury code is erased.

# Other operation

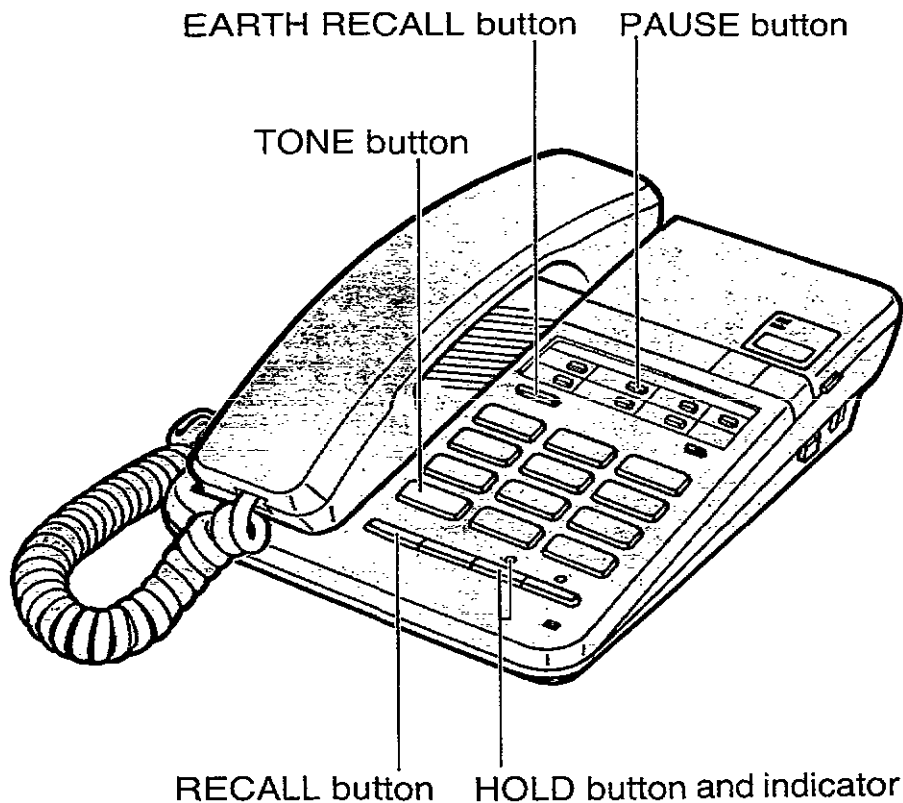

## Recall

The RECALL and EARTH RECALL buttons are used to access special telephone services such as call waiting service or call forwarding. Use these buttons properly depending on the type of the PBX that your unit is connected to.

**Use the RECALL button** for PBX with Timed Break register recall facility.

**Use the EARTH RECALL button** for PBX with Earth Recall facility.

### **Example:** Call waiting

1. During conversation, another party calls and you hear a tone.
2. Press the RECALL or EARTH RECALL button.

The first conversation is placed on hold and the second call can be answered.

To speak to the first caller again (the second caller is placed on hold), press the button again.

You may access some features of your host PBX using the RECALL button in a dialling operation.

## Hold

The HOLD button is used to keep a call on hold while having a conversation.

Press the HOLD button while having a conversation.

The HOLD indicator flashes.

You may place the handset on the cradle.

### Releasing a hold

- If the handset is off-hook; press the HOLD button again.
- If the handset is on the cradle (on-hook); lift the handset or press the MONITOR button.
- When using another telephone connected on the same line; lift the handset of the other telephone. If the hold is not released, press the hookswitch of the other telephone for about one second.

## Tone

Use the TONE button when your line has rotary telephone service. Pressing it will allow you to change dialling mode temporarily from pulse to tone during a dialling operation, and enter special tones and codes to operate answering machines, electronic banking services and other special services.

## Pause

When the apparatus is connected to your PBX's extension, dial the line access number and press the PAUSE button to access an outside line. Also when redialling, pressing the PAUSE button may be required by your host PBX.

### Example:

If the line access number is "9", press "9" and the PAUSE button. Then dial the telephone number.

Press once (3.5 seconds pause)  
Press twice (7 seconds pause)

## Combination dialling

A telephone number with more than 32 digits can be stored into two memory stations. For dialling, follow the next:

1. Lift the handset, and identify the dial tone.
2. Press the direct call button "1".
3. Press the direct call button "2".

Instead of using two memory stations, you can store a part of the telephone number into one memory station, and the other part can be dialled manually.

1. Lift the handset, and identify the dial tone.
2. Press the station key, wait for dialling to stop, then dial manually.



# ***ANSWERING MACHINE***

At first, please record your Outgoing Message before using your unit as an answering machine.  
(For Outgoing Message recording, see page 16.)

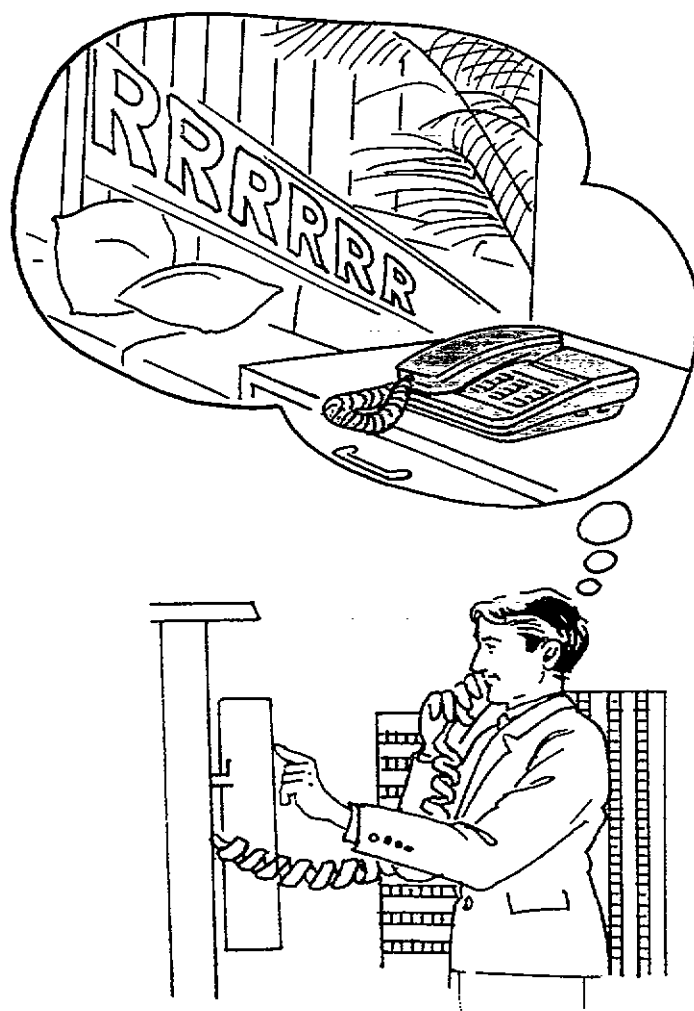

# Setting up for answering machine

Press the ANS SYS ON/OFF switch to turn on the unit. The PWR/IN USE indicator light is on. 10 second after, the ANS/CALLS indicator light is on and the unit is ready to answer the next phone call.

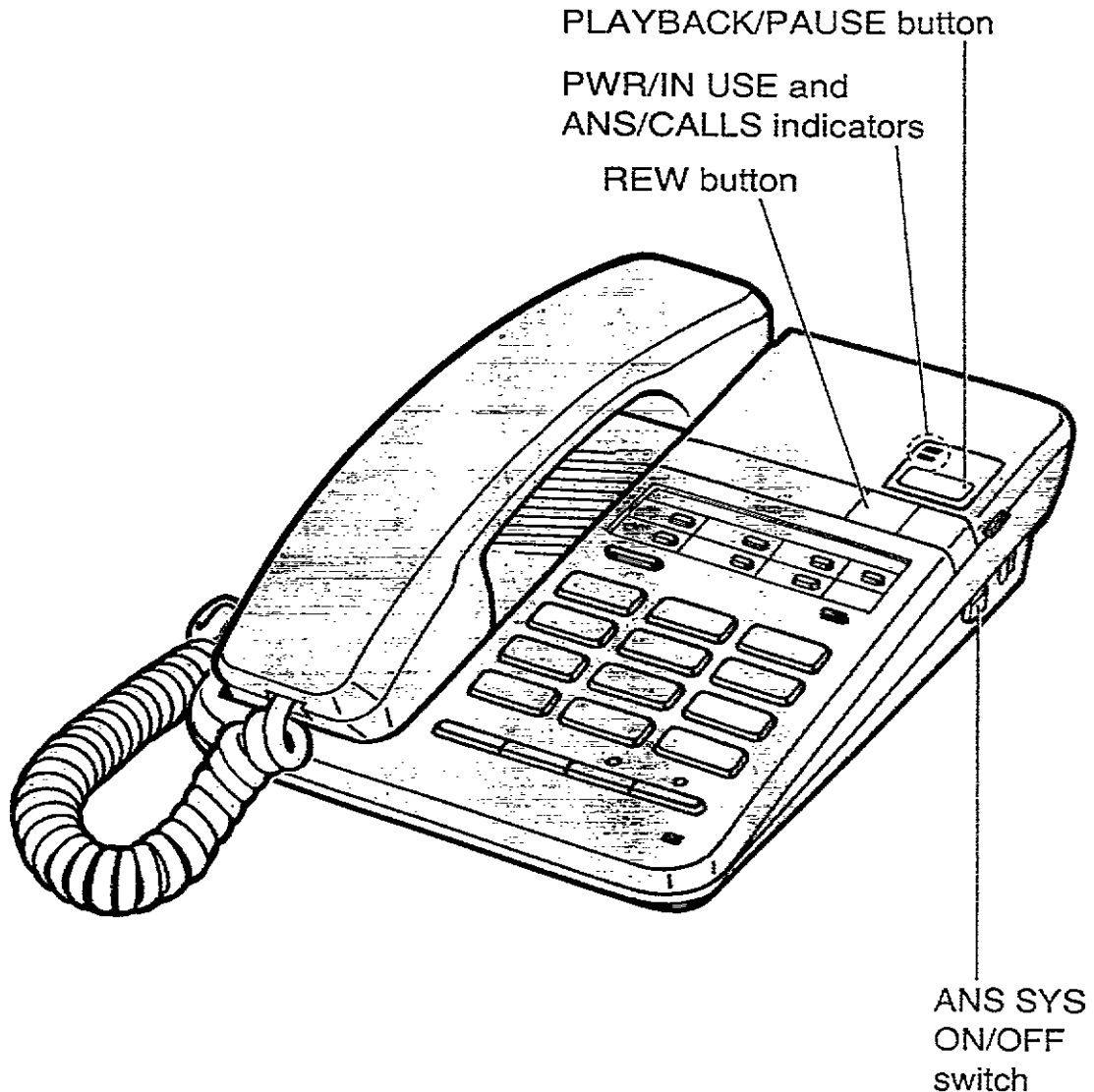

- Answer mode:  
When a call is received, the unit answers the call and record the Incoming Message.
- If you do not want the unit to answer the call, press the ANS SYS ON/OFF switch to turn off the unit. The PWR/IN USE indicator light will go out.
- Caller's recording time is limited to 2 minutes 20 seconds.

## Recording from the beginning of the ICM part of the tape

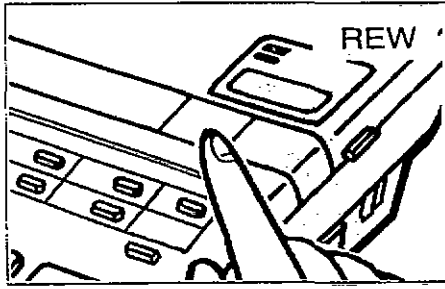

Press the REW button until the unit stops rewinding (a beep sounds), then release it.

OR

After ICM playback, leave the unit as it is. The unit has been reset to the answer mode.

New messages are recorded over the old messages.

## Recording after the messages you have heard

When you want to record the next Incoming Messages (ICMs) after the last recorded message, or after a desired position of the tape, save the messages you have heard.

1

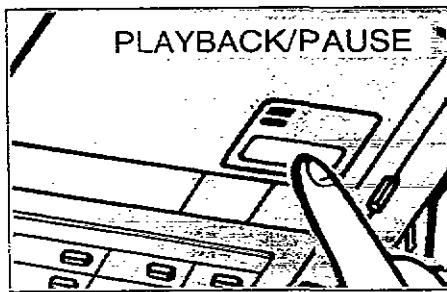

Press the PLAYBACK/PAUSE button to play back the tape to the end of the message you want to save.

2

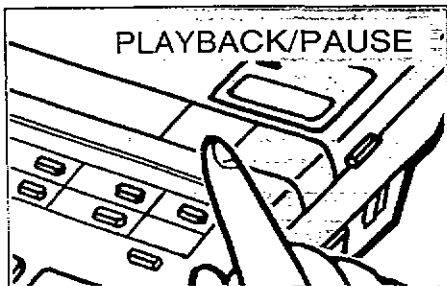

Press the PLAYBACK/PAUSE button again to pause the unit.

The PWR/IN USE indicator flashes. (Pause mode)

3

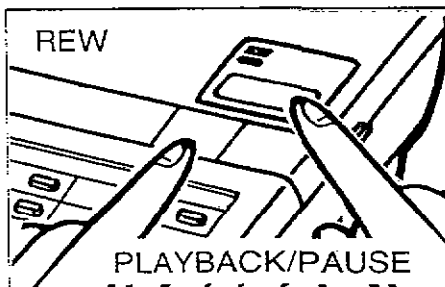

Press the REW button and the PLAYBACK/PAUSE button simultaneously.

The PWR/IN USE and the ANS/CALLS indicator lights are on. New calls will be recorded after the message(s) you have saved.

# Listening to the recorded messages

When an Incoming Message (ICM) has been recorded, the ANS/CALLS indicator will flash in groups. The amount of flashes indicates the number of messages recorded up to 15 times. (Three flashes followed by a pause means that 3 messages were recorded.)

In case of power interruption, the ANS/CALLS indicator will flash slowly.

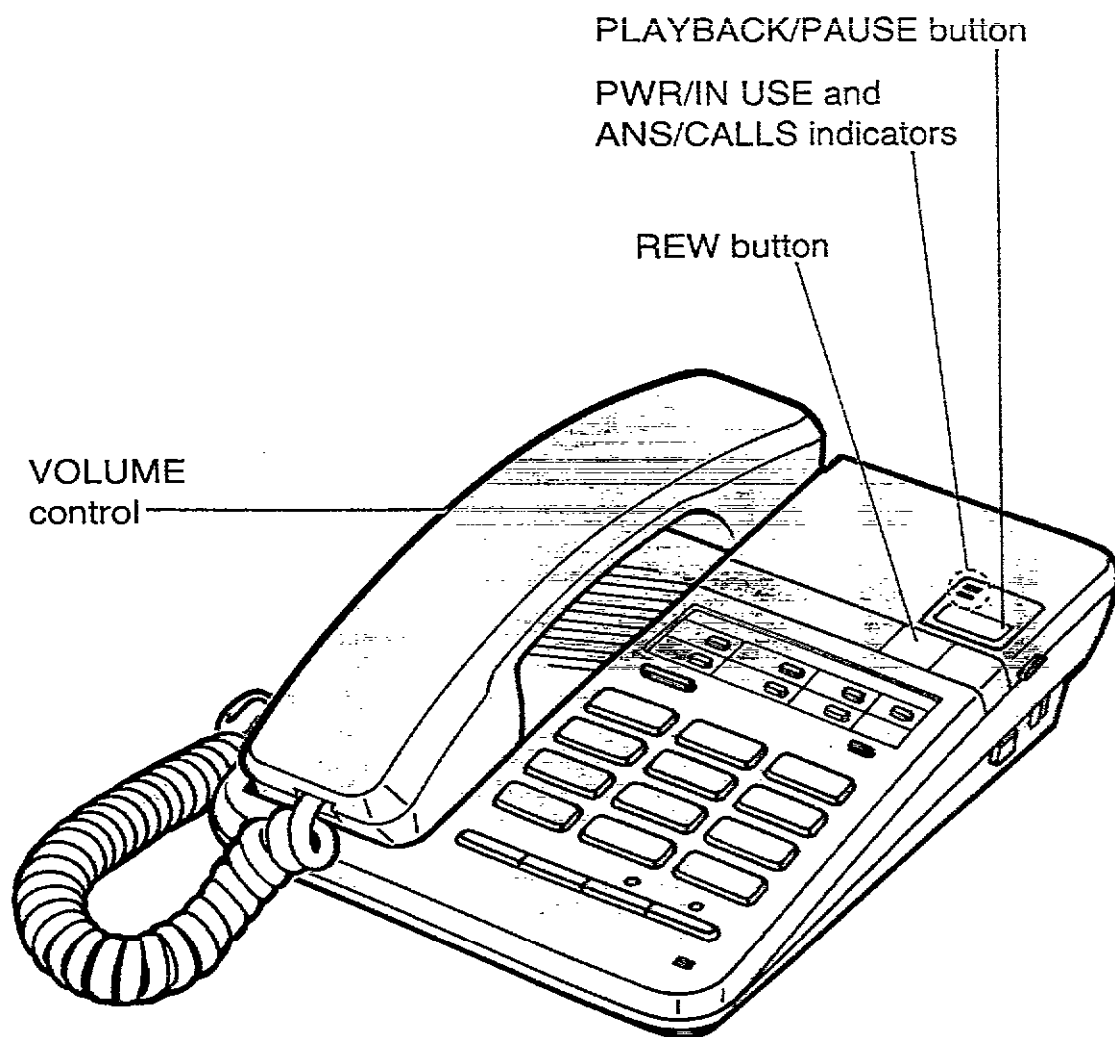

## AUTO-LOGIC

At the touch of the PLAYBACK/PAUSE button, the unit will automatically rewinds and play back all the recorded messages. 10 seconds after playback, the unit will reset the tape and be ready to record incoming calls automatically.

## Playing back the tape from the beginning

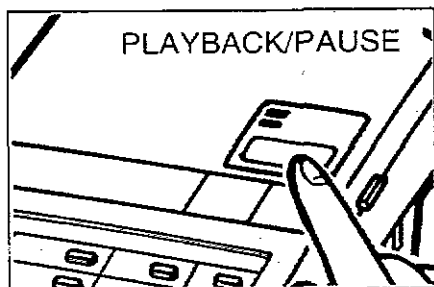

Press the PLAYBACK/PAUSE button.

The unit rewinds the tape and plays back your messages. 3 beeps will be heard indicating the end of the last message. After 10 seconds, the unit will rewind the tape, and new message will be recorded from the beginning of the ICM part of the tape.

Adjust volume, if needed.

### To pause during playback

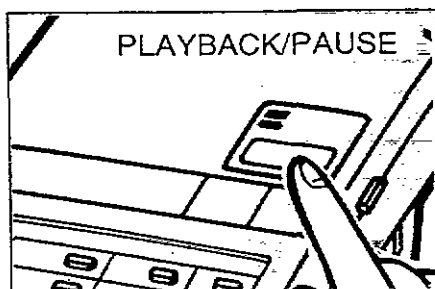

Press the PLAYBACK/PAUSE button during playback to pause the unit.

The PWR/IN USE indicator flashes (pause mode).

Press the PLAYBACK/PAUSE button again to restart playback.

### To rewind during playback

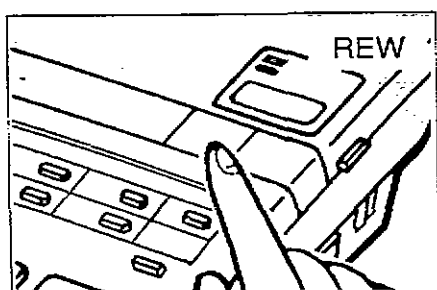

Press the REW button to rewind the tape to the desired location.

The unit will play back the message again after you release the REW button.

If you keep pressing the REW button until the unit rewinds to the beginning of the tape, a beep will be heard. In this case, the unit has been reset to the answer mode.

# Remote operation

You can retrieve the recorded Incoming Messages from a remote location with a touch tone phone by simply dialling your own remote code number.

## Remote code number

A remote code number for you is preset and indicated on the bottom of the unit.

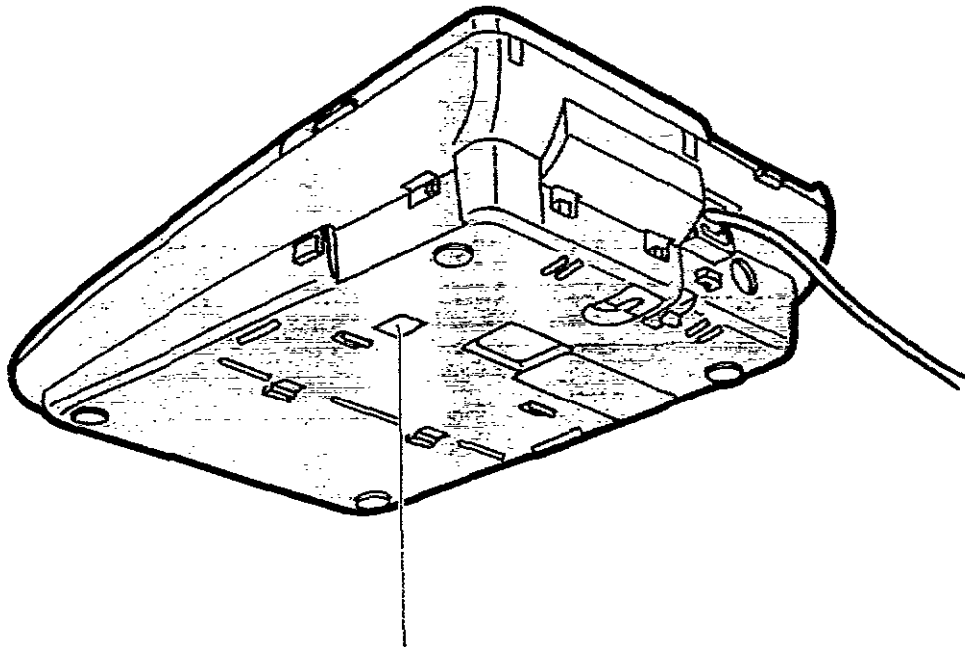

REMOTE CODE

The remote code number is indicated on the label.

## Playing back all the messages

1

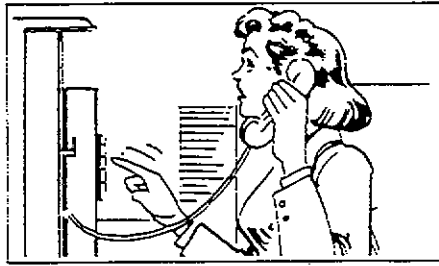

Call your unit.

2

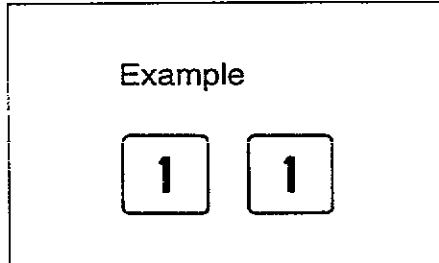

Dial your code number (for example, 1) for 1~2 seconds 2 times while the OGM is being played.

The unit rewinds the tape and plays back all the recorded messages.

To rewind, dial the code number for 1~2 seconds. The tape will rewind for approximately 15 seconds corresponding to the playback time.

After the last message, 3 beeps will sound and you may hang up. Messages are automatically saved after hanging up.

### NOTE:

During remote operation, the unit will be stopped and 2 beeps will be heard in the following conditions:

- 2 minutes 30 seconds after your unit answered.
- Every 2 minutes 30 seconds after pressing the command button.

To listen further messages, dial your code number for 1~2 seconds within 10 seconds of hearing two beeps.

## Resetting the tape for future message

After listening to the messages, you can reset the tape and record new messages from the beginning.

1

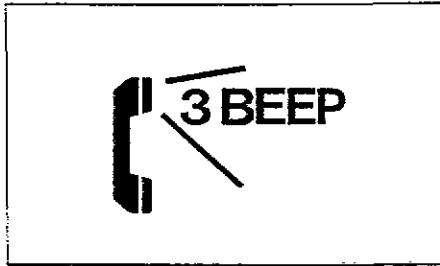

Wait for 3 beeps after the last message.

2

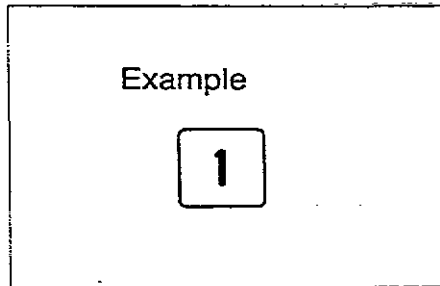

Press the code number within 10 seconds of hearing 3 beeps.

The unit will rewind the tape to the beginning. Future messages will be recorded and the old messages will be lost.

## Recording a marker message

After listening to all your messages, you can leave a message on the same call. When replay is finished, wait for 3 beeps indicating the end of the last message. Then wait about 10 seconds for another 2 beeps indicating that the tape is ready for recording. Leave your message after the last 2 beeps. Hang up when finished.

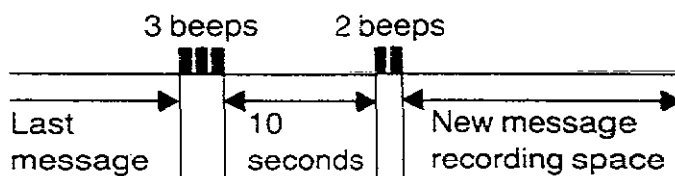

## Setting the answer mode remotely

You can easily set the answer mode from a remote telephone.

1. Call your unit and let the telephone ring 20 times.
2. The unit will answer, and the OGM will be heard, then hang up.  
The unit will be ready to answer the next phone call.



# Recording a memo message

If you want to leave a memo message for someone, you can record it on the tape. It can then be played back either manually or remotely just like any other recorded Incoming Messages.



1

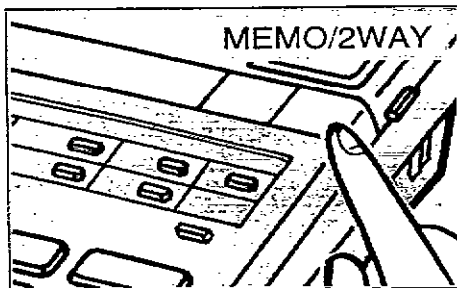

Press the MEMO/2WAY button until a beep sounds.

A series of short beeps will be heard followed by a long beep.

2

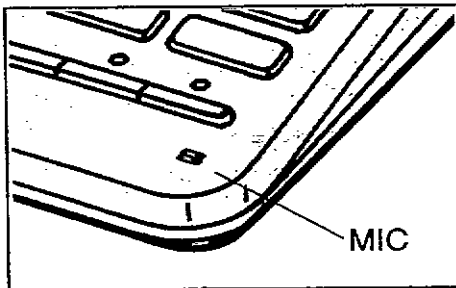

Immediately after the long beep, speak loudly and clearly, about 20 cm away from the microphone.

The PWR/IN USE indicator flashes. Your recording time is up to 2 minutes 20 seconds.

3

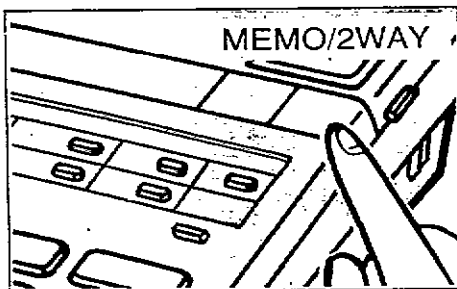

Press the MEMO/2WAY button again when you finished recording.

The unit rewind the tape to the beginning, and is ready to answer the next phone calls.

The PWR/IN USE indicator light is on and the ANS/CALLS indicator flashes to show that your message was recorded.

# Recording a conversation (2-way recording)

You can record a telephone conversation.

1

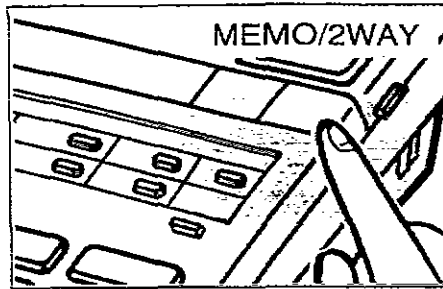

Press the MEMO/2WAY button until a beep sounds during your conversation, and continue speaking.

The PWR/IN USE indicator flashes and the ANS/CALLS indicator lights is on.  
A beep will be heard every 15 seconds.

2

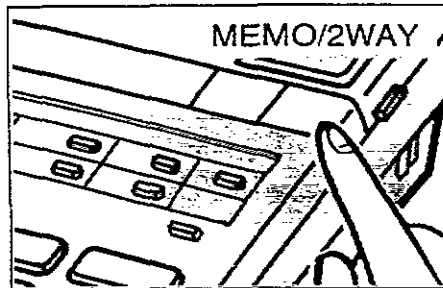

Press the MEMO/2WAY button again when you finish recording.

The PWR/IN USE indicator light is on and the ANS/CALLS indicator goes out.  
The unit rewinds and resets the tape, and be ready to answer the next phone call.  
The ANS/CALLS indicator flashes to show that the conversation was recorded.

- The recorded conversation can be played back either manually or remotely just like any other recorded Incoming Messages.

# Monitoring the incoming calls

You may leave the unit in answer mode even when you are around. In this case, after the unit has answered, you will monitor the caller speaking. You can interrupt the recording and speak to the caller by simply lifting the handset. The unit will automatically stop recording. After hanging up, the unit will be ready to answer the next phone call.

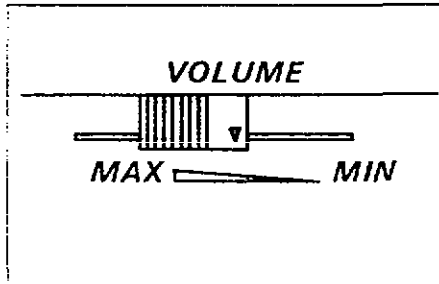

Adjust the VOLUME control if needed.

# Troubleshooting guide

Problem	Cause & Remedy
The unit does not work when I press any buttons.	<ul style="list-style-type: none"><li>● Plug in the AC adaptor again.</li><li>● The unit is turned off. Press the ANS SYS ON/OFF switch to turn on the unit.</li></ul>
The unit does not ring.	<ul style="list-style-type: none"><li>● The RINGER VOLUME selector is set to the "OFF" position. Set it to the "HIGH" or "LOW" position.</li></ul>
I try to store the telephone number into memory station, but the storing procedure cannot be done.	<ul style="list-style-type: none"><li>● Be sure that the AC adaptor is connected and handset is on the cradle.</li></ul>
I try to store the Mercury code into memory, but it cannot be stored.	<ul style="list-style-type: none"><li>● Be sure that the AC adaptor is connected.</li><li>● The memory of the Mercury code stored before have not been reset yet. Reset the old memory (See page 29.), and reprogram.</li></ul>
The Outgoing Message is recorded improperly.	<ul style="list-style-type: none"><li>● Record a new Outgoing Message.</li><li>● Clean the heads. (See page 46.)</li></ul>
When I press the OGM REC button to record my Outgoing Message, the unit does not start recording, and a beep sounds 6 times and the ANS/CALLS indicator flashes.	<ul style="list-style-type: none"><li>● The cassette tape might be broken. Replace it with a new one.</li></ul>
When I record an Outgoing Message, a beep sounds 6 times and the unit stops recording.	<ul style="list-style-type: none"><li>● Re-record your Outgoing Message. Speak clearly and loudly, and do not pause for over 2 seconds while recording.</li></ul>

---

**Problems****Cause & Remedy**

---

When the cassette tape is played back, the sound level is low, even if the VOLUME control is turned up fully.

- Clean the heads. (See page 46.)

---

I want to record the next Incoming Messages after the last previously recorded messages that I have heard.

- Save the old messages. (See "Recording after the messages you have heard" on page 34.)
- In case of remote operation, just hang up.

---

The unit does not answer remotely.

- If you can hear ring-tone but the unit fails to answer, this is because the power of the unit is turned off. (The unit is not in the answer mode.) Set the unit to the answer mode by call your telephone number and ring for 20 times. (See page 39.)

---

I try to operate from a remote touch tone phone, but the unit does not respond when I press any button.

- Make sure that you are entering your correct remote code number.
- When you press a button, press firmly.
- In some areas, a remote touch tone phone may not function due to telephone line conditions such as line noise, echo, etc.
- The unit may not respond if a remote touch tone phone produces tones that are too short to activate the unit.

---

The ICM tape continues to run after a caller hangs up.

- Set the VOX SENS selector to the "L" position.
-

# Wall mounting

The unit can be mounted on a wall utilizing the washers and screws provided.

1

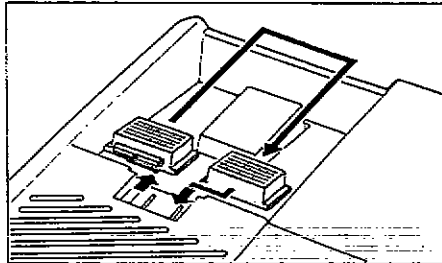

Turn around the handset hook.

2

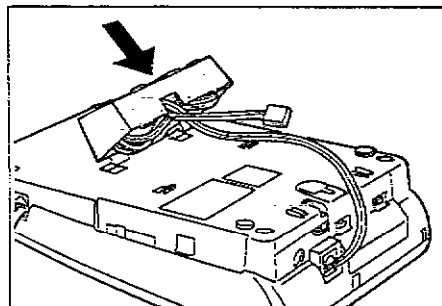

Place the wall mount adaptor as shown.

3

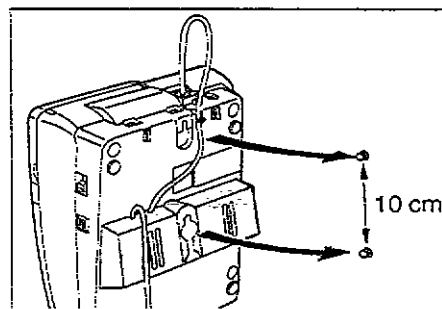

Install the screws and washers using the wall template indicated below, then mount the unit eyelets as shown.

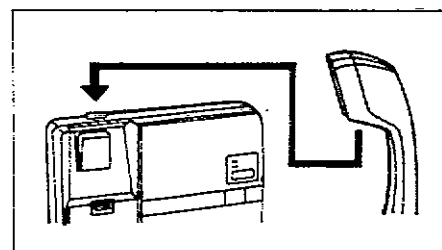

To temporarily place the handset down during a conversation, hook as shown.

## Wall Template

Drill here

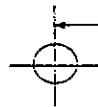

10cm

Drill here

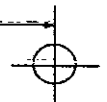

- 45 -

# Maintenance

Because the head and capstan assemblies are in contact with the tape, dirt and residue from the tape can easily adhere to these parts, causing distortion. These parts should be cleaned periodically in the manner described below.

(To open the cassette cover, see page 10.)

**WARNING:** UNPLUG THE CONNECTION TO THE B.T. NETWORK BEFORE OPENING THE CASSETTE COVER.

Clean the head surface, pinch roller and capstan with a cotton swab. If these surfaces are extremely dirty, dampen the cotton swab with alcohol.

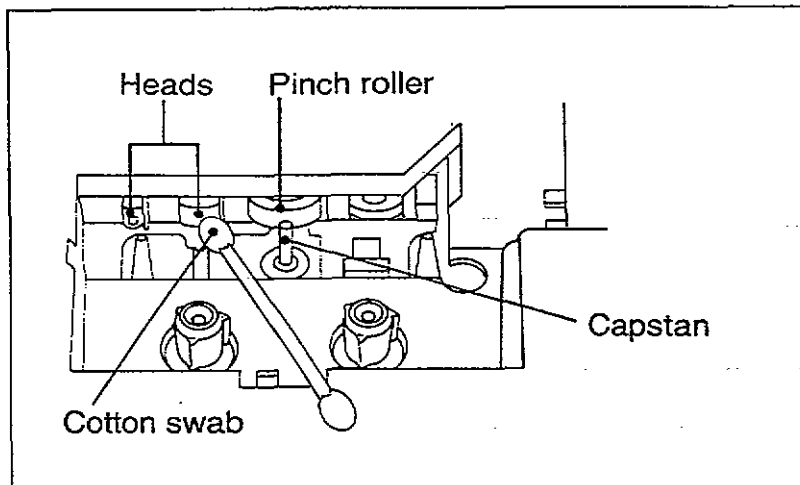

- Do not place magnetic or metal objects, such as a screwdriver, near the head assemblies, as such objects could magnetize the heads.
- Do not oil any part of the unit.

### Cassette tape

- For optimum sound quality and performance, we recommend that you **use the opposite side (side-2) after six months and replace the tape with a new one every year**, assuming that the unit answers about ten calls a day.
- Never place a cassette tape near a magnetic source, such as a magnet or a TV set, because it may erase or break the recorded message on the tape.
- Slack in the tape can be tightened by rotating the tape reel with an instrument like a pencil, as shown.

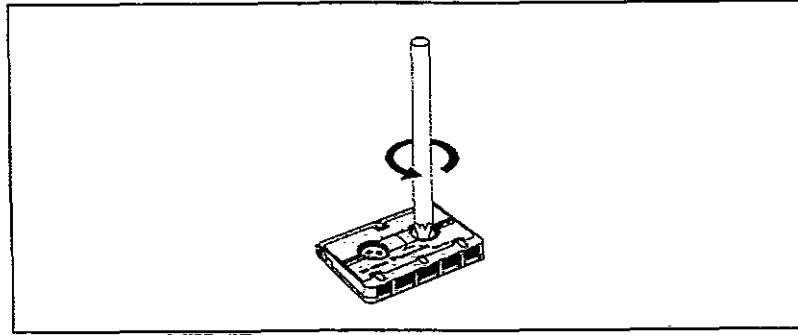

### Cassette panel installation

If the panel comes off, replace it by pushing as shown.

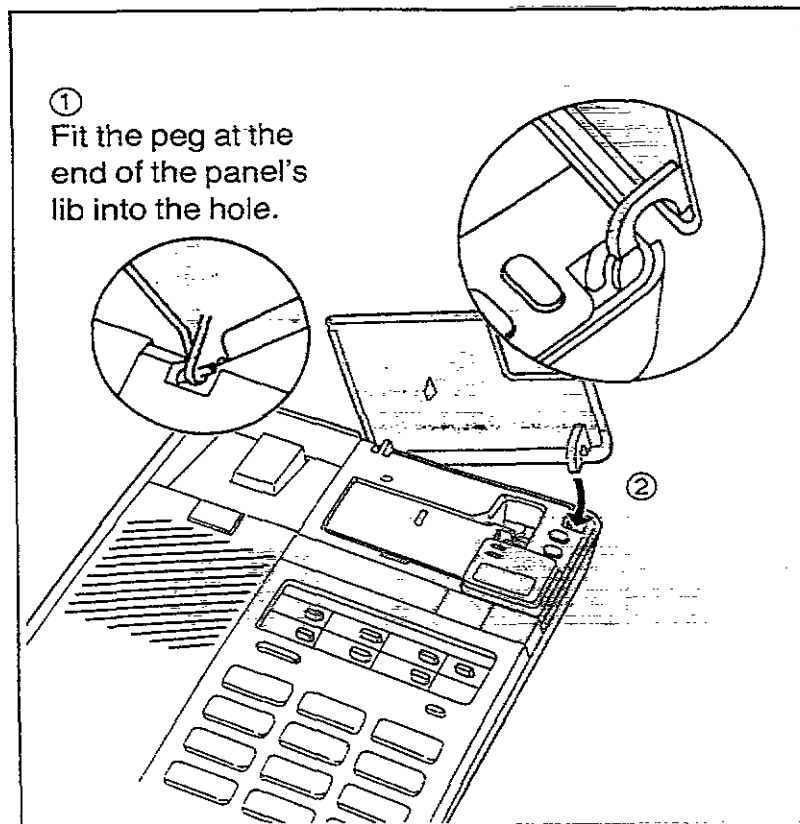



# Others

Take special care to follow the safety suggestions listed below.

## Safety

- 1) **Power Source:** The apparatus should be connected to a power supply only of the type described in the operating instructions or as marked on the apparatus.
- 2) **Nonuse Periods:** When the apparatus is not used, turn the power off. When left unused for a long period of time, the apparatus should be unplugged from the household AC outlet.

## Placement

- 1) **Foreign Material:** Care should be taken so that objects do not fall into and liquids are not spilled into the apparatus. Do not subject this apparatus to excessive smoke, dust, mechanical vibration, or shock.
- 2) **Magnetism:** The apparatus should be situated away from equipment or devices that generate a strong magnetic field.
- 3) **Stacking:** Do not place heavy objects on top of this apparatus.
- 4) **Surface:** Place the apparatus on a flat level surface.

## Installations

### Environment

- 1) **Water and Moisture:** Do not use this apparatus near water—for example, near a bath tub, washbowl, sink, etc. Damp basements should also be avoided.
- 2) **Heat:** The apparatus should be situated away from heat sources such as radiators, kitchen range, etc. It also should not be placed in temperatures less than 5°C or greater than 40°C.

### WARNING:

TO PREVENT FIRE OR SHOCK HAZARD, DO NOT EXPOSE THIS PRODUCT TO RAIN OR ANY TYPE OF MOISTURE.



### KX-T2396BE QUICK REFERENCE CARD FOR TONE REMOTE CONTROL

To set the answer mode remotely.

1. Dial the phone number and wait for 20 rings.
  - The unit will answer and play the OGM.
2. Hang up the handset.
  - The unit will be ready to answer the next phone call.

When you press any button, press firmly for 1~2 second.

Your remote code no. \_\_\_\_\_



Dial the telephone number with a tone telephone only.

Press your code no. 2 times during playback OGM. The unit will play back.

- For Back Space, press your code no.
- To record the ICM from the beginning of the tape, press your code no. after 3 beeps.
- To save the ICM, hang up after playback.
- To leave a marker message, speak after 3 beeps followed by a 10-second pause and 2 beeps.
- To continue, press your code no. after hearing 2 beeps during playback.

# GUARANTEE

## CONDITIONS OF GUARANTEE

This guarantee is in addition to and does not in any way affect any statutory or other rights of consumer purchasers. If within the applicable guarantee period, the appliance proves to be defective by reason of faulty design, workmanship or materials, we undertake subject to the following conditions to have the defective appliance (or any part or parts thereof) repaired or replaced free of charge.

1. The appliance shall have been purchased and used solely within the UK and in accordance with standard operating instructions and the technical and/or Safety Standards required in the UK.
2. The purchaser will within 7 days of purchase complete the included card and send it to us for registration. Failure to return such card could result in delay in providing the guarantee service.
3. The appliance should be returned together with this guarantee and proof of date of purchase promptly on being found defective at the purchaser's risk and expense to the authorized dealer from whom the appliance was purchased or to the nearest authorized dealer. All enquiries must be through such dealers.
4. This guarantee shall not apply to damage caused through fire, accident, lightening, misuse, wear and tear, neglect, incorrect adjustment or repair, to damage caused through installation, adaption, modification or use in an improper manner or inconsistent with the technical and/or safety standards required in the country where this appliance is used, or to damage occurred during transit to or from the purchaser.
5. If at any time during the guarantee period any part or parts of the appliance are replaced with a part or parts not supplied or approved by us or of an objective quality safe and suitable for the appliance, or the appliance has been dismantled or repaired by any person not authorized by us, we shall have the right to terminate this guarantee in whole or in part immediately without further notice.
6. The purchaser's sole and exclusive remedy under this guarantee against us is for the repair or replacement of the appliance or any defective part or parts and no other remedy, including, but not limited to, incidental or consequential damage or loss of whatsoever nature shall be available to the purchaser.
7. This guarantee shall not apply to cassette tapes, batteries and any other items of limited natural life.
8. Our decision on all matters relating to complaints shall be final. Any appliance or defective part which has been replaced shall become our property.
9. The guarantee period applicable to this product shall be 12 months.

Please keep this Operating Instructions with your receipt.

### **Panasonic Business Systems U.K.**

---

Receipt No.

Date of Purchase

---

Model No.

Serial No.

**KX-T2396BE**

---

**Matsushita Electric Industrial Co., Ltd.**  
Central P. O. Box 288, Osaka 530-91, Japan

Printed in Japan .....PQQX6580ZA E0691U0.....

STAMP  
REQUIRED

# Panasonic Business Systems U.K.

WILLOUGHBY RD.  
BRACKNELL, BERKSHIRE  
RG12 4FP



## POST CARD

STAMP  
REQUIRED

**The Telephone Manager  
British Telecom Sales Department**

..... Area  
.....  
.....

MODEL No.  
KX-T2396BE

SERIAL No.

CUSTOMERS NAME etc. (BLOCK CAPITALS)

DEALERS

TELEPHONE No.

DATE OF PURCHASE

WE WOULD BE GRATEFUL IF YOU WOULD COMPLETE THE FOLLOWING BEFORE RETURNING THIS CARD FOR REGISTRATION.

Male  Female  Age ( )

1. WHAT TYPE OF STORE?

- RADIO/TV GENERAL
- HI-FI AUDIO SPECIALIST
- TELEPHONE SPECIALIST
- DEPARTMENT
- MAIL ORDER
- OTHER

2. WHEN YOU PURCHASED THIS UNIT DID YOU COMPARE WITH OTHER MODELS?

- YES  NO
- MAKE
- MODEL
- PRICE

3. WHERE DO YOU PLAN TO USE?

- LIVING ROOM
- DINING ROOM
- OFFICE
- BEDROOM
- OTHER

4. HOW DID YOU LEARN OF THIS PRODUCT?

- AD ON MAGAZINE/PAPER
- EDITORIAL IN MAGAZINE
- AD ON HOARDING
- AD ON T.V. OR RADIO
- DISPLAY IN STORE
- CATALOGUE
- OTHERS

5. WHAT PERSUADED YOU TO BUY THIS UNIT?

- TRUST IN BRAND NAME
- HIGH QUALITY
- PRICE
- DEALERS RECOMMENDATION
- FRIENDS RECOMMENDATION
- TECHNICAL SPECIFICATION
- APPEARANCE AND DESIGN
- SIMPLE CONTROLS

6. IS THIS UNIT YOUR

- FIRST OWNED?
- REPLACEMENT?

7. HOW DO YOU RATE THIS MODEL ON THE SCALE FOR:

- EXCELLENT      GOOD      POOR
- (a) PERFORMANCE
- (b) FEATURES
- (c) DESIGN
- (d) VALUE VS PRICE

8. IF FOR BUSINESS USE, HOW MANY EMPLOYEES ARE THERE IN YOUR COMPANY?

- UNDER 10       UNDER 50
- UNDER 100       100+

9. YOUR COMMENTS IF ANY

Registered No. 1485987

### CONNECTION REQUEST

For B.T. owned wiring:

The following subscriber requests you to install a wall socket to enable connection of a "direct exchange line"/P.B.X. extension line for the Panasonic KX-T2396BE Integrated Telephone System with Telephone Answering Machine which is fitted with a normal 431A connector.

Approval number S/1010/3/M/502158

Subscriber

Address

Telephone Number

Signature

\*Delete if not required.

For wiring not owned by B.T.

Request should be made to the Authorized maintainer of the PBX for extension wiring and socket installation within 14 days expiry of the period of notice will allow another installer to be employed.