

Panasonic

CORDLESS TELEPHONE

UNITED KINGDOM
MODEL NO.

KX-T3826B

Easa-Phone

Pulse-or-tone dialling capability

Operating Instructions

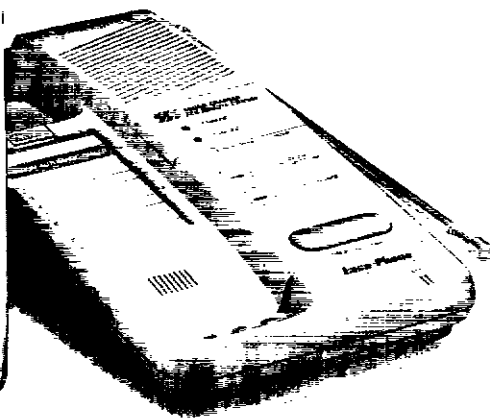
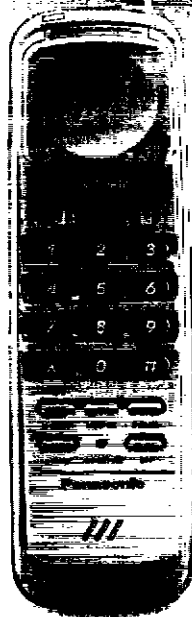

 **SOUND
CHARGER**

Charge the battery for about 10 hours before initial use.

Please read before use.

Thank you for purchasing this Panasonic Cordless Telephone.

Ringer Equivalence Number (REN):

This relates to the performance of a telephone when used in combination with other items of apparatus. It enables the calculation of the maximum number of items of apparatus that may be connected simultaneously to the line by summing the REN values of each item. A maximum REN value of 4 should not be exceeded. The REN value of this apparatus is 1. A BT supplied instrument has a REN of 1.0 unless otherwise marked.

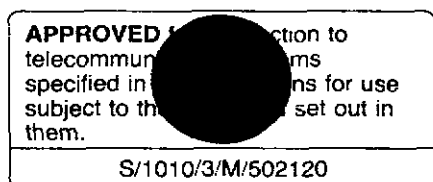

NOTE:

- If you experience any problems with the normal use of your unit, you should unplug it from the telephone outlet and connect a known working telephone in its place. If the known working telephone still gives problems, then call British Telecom Engineers; if it operates properly, then the problem is likely to be a fault in your unit. In this case, contact your supplier for advice.
- British Telecom will charge you if they attend a service call that is not due to equipment supplied by them.

WARNING:

Under certain conditions the KX-T3826BE may be unable to make emergency 999 telephone calls.

- Radio interference caused by another cordlessphone operating on the same radio frequency.
- The portable unit needs recharging.

- The base unit back-up batteries are exhausted. With the batteries in good condition the base unit will be able to operate without mains power for at least seven hours, including one hour in the TALK mode.
- The portable unit cannot be used while charging.

How to connect the Mains Leads to a plug:

- Do not connect the mains leads to any electrical outlets other than the standard 240VAC, 50 Hz.
- The power supply unit complies with BS6301: 1982.
- Outlet voltage 18VDC, 300mA.
- The apparatus is approved for use with the KX-A29 BE power supply.
- **CAUTION:** Do not remove cover. Live parts inside.

Interconnection directly, or by way of other apparatus, of ports marked "SAFETY WARNING. See instructions for use." with ports marked or not so marked may produce hazardous conditions on the network and advice should be obtained from a competent engineer before such a connection is made.

Method of connection:

The apparatus can be connected to the exchange line or PABX/PMBX extension by the new standard British Telecom plug and socket.

Arrangements for provision of this type of termination can be made through the nearest British Telecom Sales Office.

The apparatus may be connected to the following types of installation. The apparatus has been approved for use under the following conditions:

- (a) For connection to the public switched telephone network (PSTN) or compatible PBX (Private Branch Exchange), which use loop disconnect signalling. Please consult your supplier for an up to date list of compatible PBX's.
- (b) The apparatus can be used on extension sockets connected to a direct exchange line (D.E.L.).
- (c) This apparatus is suitable for connector to the telecommunication system directly or via compatible private branch exchange as an extension. The apparatus is suitable for connection to a PBX which returns secondary proceed indication.
The supplier of the apparatus should be consulted for an up to date list of PBX's with which the apparatus is compatible.
- (d) The apparatus must not be connected in the following manner:
 - 1) As an extension to a pay phone
 - 2) As a party line with shared service
 - 3) As part of 1+1 carrier systems

It cannot be guaranteed that the apparatus will operate under all possible conditions of connection to compatible PBX's.

Any cases of difficulty should be referred in the first instance to the supplier of the apparatus.

The apparatus has been approved for the use of the following facilities:

- 1) Storage of telephone numbers for retrieval by a predetermined code
- 2) Automatic Dialling
- 3) Automatic storage of last number dialled
- 4) Repeat Attempt: single
- 5) Simple telephone facility
- 6) PBX earth register recall, PBX timed break register recall
- 7) MF signalling
- 8) LD signalling (Loop disconnect)
- 9) Loud speaking
- 10) Hold
- 11) Mute

Any other usage will invalidate the approval of the apparatus if as a result, it then ceases to conform the standards against which approval was granted.

999 can be dialled on the apparatus for the purposes of making outgoing calls to the BT emergency (999) Service.

There is a possibility of occurrence of overhearing between cordless telephones operating on the same radio channel. And such interference may increase with greater usage of cordless telephones.

You may not be able to dial 999 in some conditions as follows:

- co-channel interference
- failure of the portable unit battery
- failure of the battery in the AC adaptor

This cordless telephone has been designed to operate on radio frequencies which have been assigned to the exclusive use of cordless telephone. As the use of cordless telephones becomes more widespread users may experience a reduction in the quality of service obtainable from this apparatus.

You may receive interference on some domestic radio receivers because the cordless telephone transmission is at 1.7 MHz leg.

**FOR YOUR SAFETY PLEASE
READ THE FOLLOWING TEXT
CAREFULLY.**

This appliance is supplied with a moulded three pin mains plug for your safety and convenience.

A 5 amp fuse is fitted in this plug. Should the fuse need to be replaced please ensure that the replacement fuse has a rating of 5 amps and that it is approved by ASTA or BSI to BS1362.

Check for the ASTA mark  or the BSI mark  on the body of the fuse.

If the plug contains a removable fuse cover you must ensure that it is refitted when the fuse is replaced. If you lose the fuse cover the plug must not be used until a replacement cover is obtained. A replacement fuse cover can be purchased from your local Panasonic Dealer.

IF THE FITTED MOULDED PLUG IS UNSUITABLE FOR THE SOCKET OUTLET IN YOUR HOME THEN THE FUSE SHOULD BE REMOVED AND THE PLUG CUT OFF AND DISPOSED OF SAFELY. THERE IS A DANGER OF SEVERE ELECTRICAL SHOCK IF THE CUT OFF PLUG IS INSERTED INTO ANY 13 AMP SOCKET.

If a new plug is to be fitted please observe the wiring code as shown below.
If in any doubt please consult a qualified electrician.

IMPORTANT:

The wires in this mains lead are coloured in accordance with the following code:

Blue: Neutral
Brown: Live

As the colours of the wire in the mains lead of this appliance may not correspond with the coloured markings identifying the terminals in your plug, proceed as follows.

The wire which is coloured BLUE must be connected to the terminal in the plug which is marked with the letter N or coloured BLACK.

The wire which is coloured BROWN must be connected to the terminal in the plug which is marked with the letter L or coloured RED.

Under no circumstances should either of these wires be connected to the earth terminal of the three pin plug, marked with the letter E or the Earth Symbol \perp .

How to replace the fuse:

Open the fuse compartment with a screwdriver and replace the fuse and fuse cover.

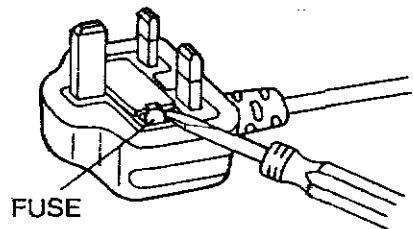

Contents

Precautions	5
Location of controls	7~10
Portable unit	7
Base unit	9
Connection	11
Initial preparation	13
Charging the battery of the portable unit	15
Replacing the battery of the portable unit	16
Making and answering calls	17
Automatic dialling	19~21
Storing telephone numbers for automatic dialling	19
Correcting an error while storing	20
Confirming a stored number	20
Erasing a stored number	20
Dialling	21
Intercom	22~23
Paging from the base unit to the portable unit	22
Paging from the portable unit to the base unit	23
Transferring an incoming call	24~25
Transferring from the base unit to the portable unit	24
Other features	26~28
CH button	26
TONE button	27
RECALL button	28
PAUSE (PAGE/P.) button	28
Combination dialling	28
Mercury feature	29
Battery installation of the AC adaptor	31
Wall mounting	32
Troubleshooting guide	33

Precautions

Before using this unit, please read these operating instructions carefully. Take special care to follow the suggestions listed below.

Safety

- 1) Power Source:
The unit should be connected to a power supply only of the type described in the operating instructions or as marked on the unit.
- 2) Nonuse Periods:
When the unit is not used, turn the power off. When left unused for long periods of time, the base unit should be unplugged from the household AC outlet.

Installations

Environment

- 1) Water and Moisture:
Do not use this unit near water—for example, near a bath tub, washbowl, sink or the like. Damp basements should also be avoided.
- 2) Heat:
The unit should be situated away from heat sources such as radiators, kitchen range, etc. It also should not be placed in rooms where the temperature is less than 5°C or greater than 40°C.

Placement

- 1) Foreign Material:
Care should be taken so that objects do not fall into and liquids are not spilled into the unit. Do not subject this unit to excessive smoke, dust, mechanical vibration, or shock.

- 2) Magnetism:
The unit should be situated away from equipment or devices that generate a strong magnetic field.
- 3) Stacking:
Do not place heavy objects on top of this unit.
- 4) Surface:
Place the unit on a flat, level surface, or use the wall mounting adaptor for wall installation.

For best performance

- 1) Both the base unit and portable unit should be used with the antenna fully extended.
- 2) The unit should be situated away from the personal computer, television, radio or fax. They may interfere with each other.
- 3) If noise prevents the conversation from being understood at the portable unit, approach the base unit to lessen the noise.
- 4) The portable unit should be used at the "HIGH" volume setting when the reception tone is difficult to hear.
- 5) The portable unit should be fully recharged on the base unit when the MULTI indicator flashes.
- 6) The antenna of the portable unit should not be touched during the use because of its high sensitivity.
- 7) The possible calling distance may be shortened when the unit is used in the following places.
Near obstacles such as hills, tunnels, undergrounds, near metal object such as wire fence, etc.

- 8) If Household appliances are plugged into the same circuit as the base unit, interference can be sometimes caused. Try moving the appliance or the base unit to another outlet.
- 9) The layout of your home or office may be limiting the operating range. Try moving the base unit to another location.

If there is any trouble, disconnect the unit from the telephone line and connect a known working phone operates properly, do not reconnect the unit to the telephone line until the trouble has been repaired. If the known working phone does not operate properly, consult with a phone company.

WARNING:
 TO PREVENT FIRE OR SHOCK HAZARD, DO NOT EXPOSE THIS PRODUCT TO RAIN OR ANY TYPE OF MOISTURE.

Enclosures

AC adaptor one
 (KX-A29BE)

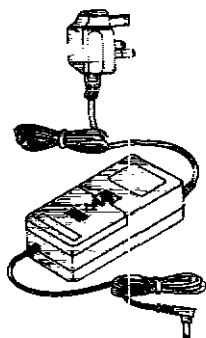

Wall-mounting adaptor one

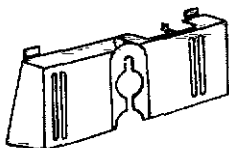

Screws two
 Washers two

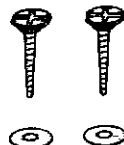

Location of controls

PORTABLE UNIT

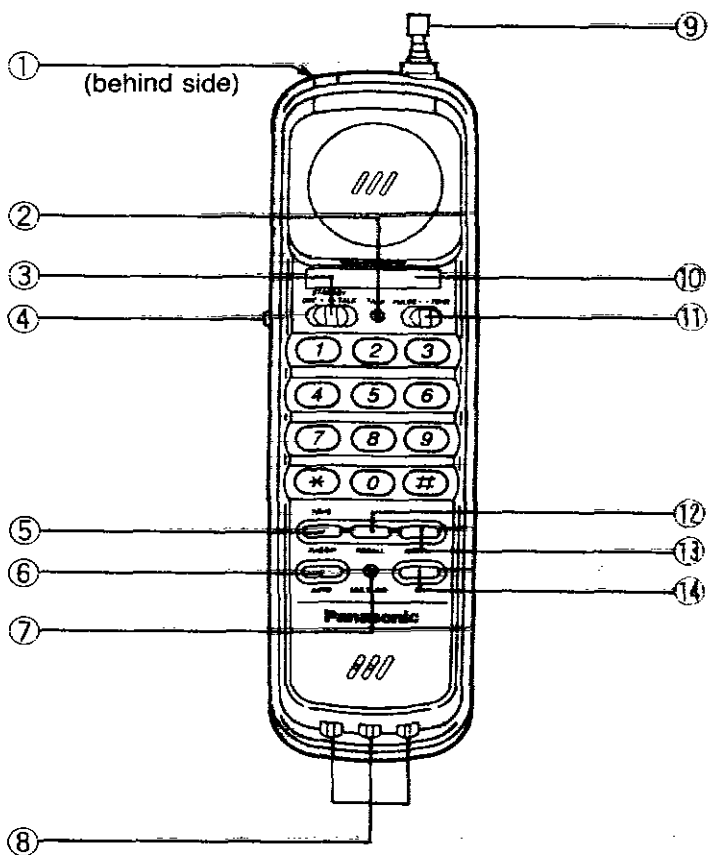

Memory Card

You can also use the reverse side for writing down the stored numbers. The instructions for storing numbers into memory stations and automatic dialling are printed on this card.

- ①**Memory Card:**
Used to write stored telephone numbers.
- ②**TALK Indicator**
- ③**Function Selector:**
Used to turn on and off the unit. (See page 14.)
- ④**VOLUME Selector:**
Used to adjust the volume level of the portable unit. (See page 14.)
- ⑤**PAGE/P. (pause) Button:**
Use to page the base unit. (See page 23.)
Used to pause during a programming or dialling operation.
(See page 28.)
- ⑥**AUTO Button:**
Used to store the telephone numbers in memory and to dial the stored telephone number. (See page 19.)
- ⑦**MULTI Indicator**
- ⑧**Battery Charge Contacts**
- ⑨**Antenna**
- ⑩**Number Card:**
Used to write your telephone number.
- ⑪**Dialling Mode Selector:**
Used to select either PULSE or TONE dialling. (See page 14.)
- ⑫**RECALL Button:**
Used to access some features of your host PBX and your telephone company. (See page 28.)
- ⑬**REDIAL Button:**
Used to redial the last dialled telephone number. (See page 18.)
- ⑭**CH (channel) Button:**
Used to select a clear channel when you hear interference noise.
(See page 26.)

Location of controls

BASE UNIT

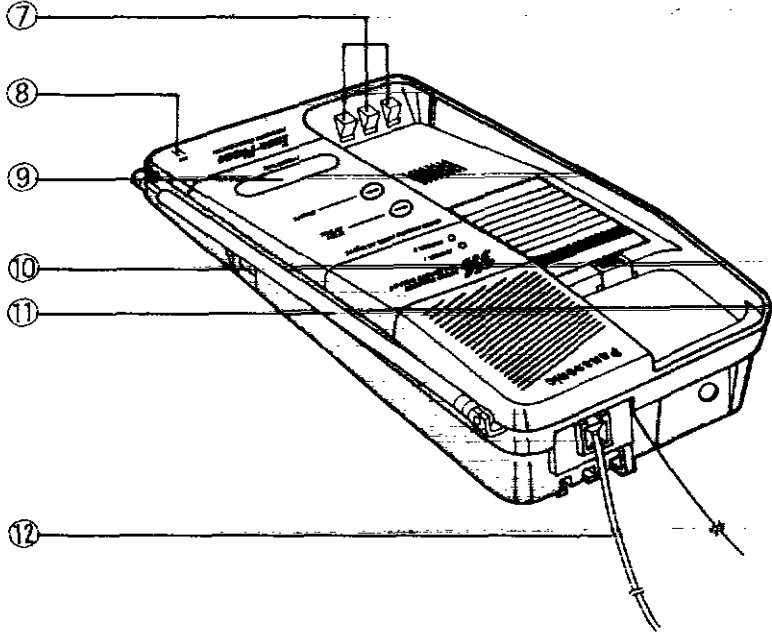
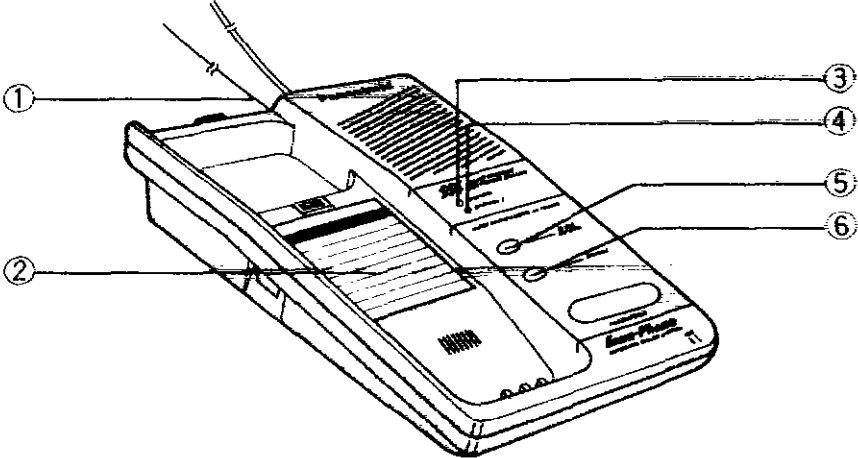

① **Transmitter Wire Aerial**

② **Memory Card:**

Used to write stored telephone numbers.

③ **CHANNEL 1 Indicator**

④ **CHANNEL 2 Indicator**

⑤ **IN USE/INT'COM (intercom) Indicator**

⑥ **CHARGE Indicator**

⑦ **Battery Charge Contacts**

⑧ **MIC (microphone)**

⑨ **PAGE/INT'COM (intercom) Button:**

Used to page the portable unit. (See page 22.)

⑩ **RECALL Selector:**

Used to access some features of your host PBX and your telephone company. (See page 14.)

⑪ **Antenna**

⑫ **Telephone Line Cord**

Connection

Connect as shown.

Please purchase optional batteries (AA, R6 or UM-3 size) and install them into the AC adaptor against a power failure. (See page 31.)

USE ONLY Panasonic AC ADAPTOR KX-A29BE.

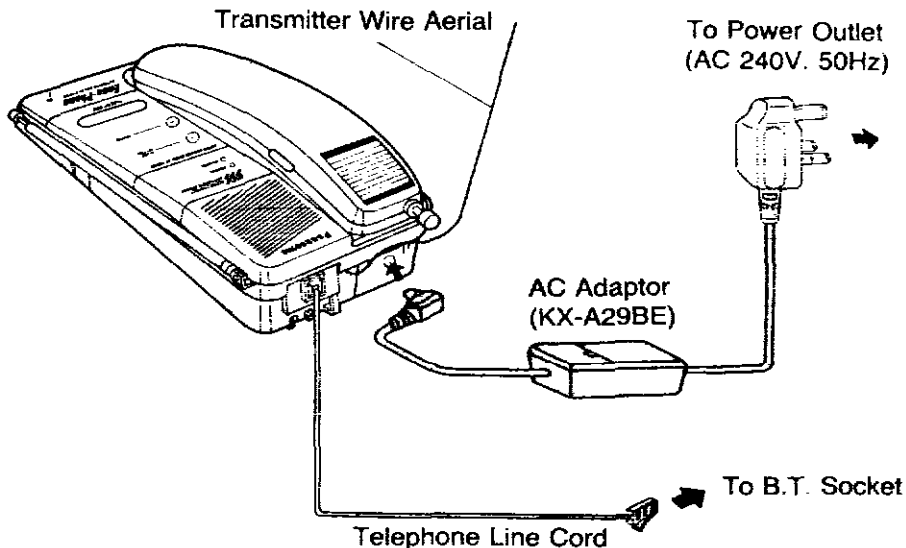

Fasten the cord to the cord holder.

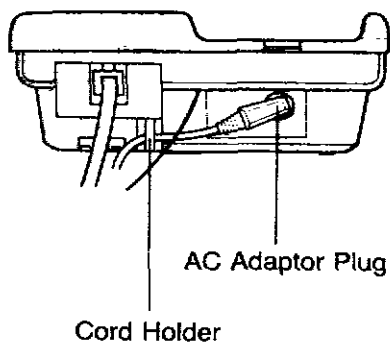

To connect another telephone on the same line, please use T-Adaptor.

To B.T. Socket

T-Adaptor

Another Telephone KX-T3826BE

The diagram shows a T-adaptor connected to a B.T. socket. One line from the socket goes to a standard telephone, and another line goes to the transmitter (KX-T3826BE).

WARNING

Identified ports do not provide isolation sufficient to satisfy the requirements of BS 6301. Apparatus connected to such ports should either have been approved to BS 6301 or have previously been evaluated against British Telecommunications plc (Post Office) Technical Guides 2 or 26 and given permission to attach. Other usage will invalidate any approval given to the apparatus.

CONNECTION OF POWER SUPPLY

This apparatus is intended for use when powered by KX-A29BE. Other usage will invalidate any approval given to this apparatus if as a result it ceases to comply with the edition of BS 6301 to which it was approved.

Installing the transmitter wire aerial

The transmitter wire aerial is used to transmit to the portable unit. To obtain the best performance of it, uncoil the aerial to its full extension and hang or fix it in the upward vertical direction.

Extend the telescopic antenna of the base unit fully and vertically for the best performance.

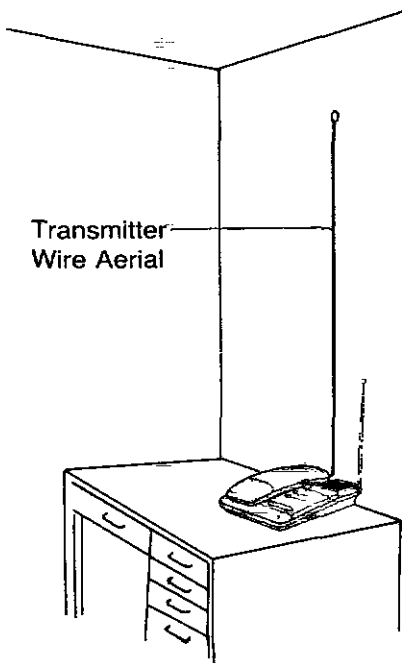

Initial preparation

Charge the battery for about 10 hours before initial use. (See page 15.)

Telescopic antenna:

Extend the telescopic antenna of the portable unit fully for best performance when using it.

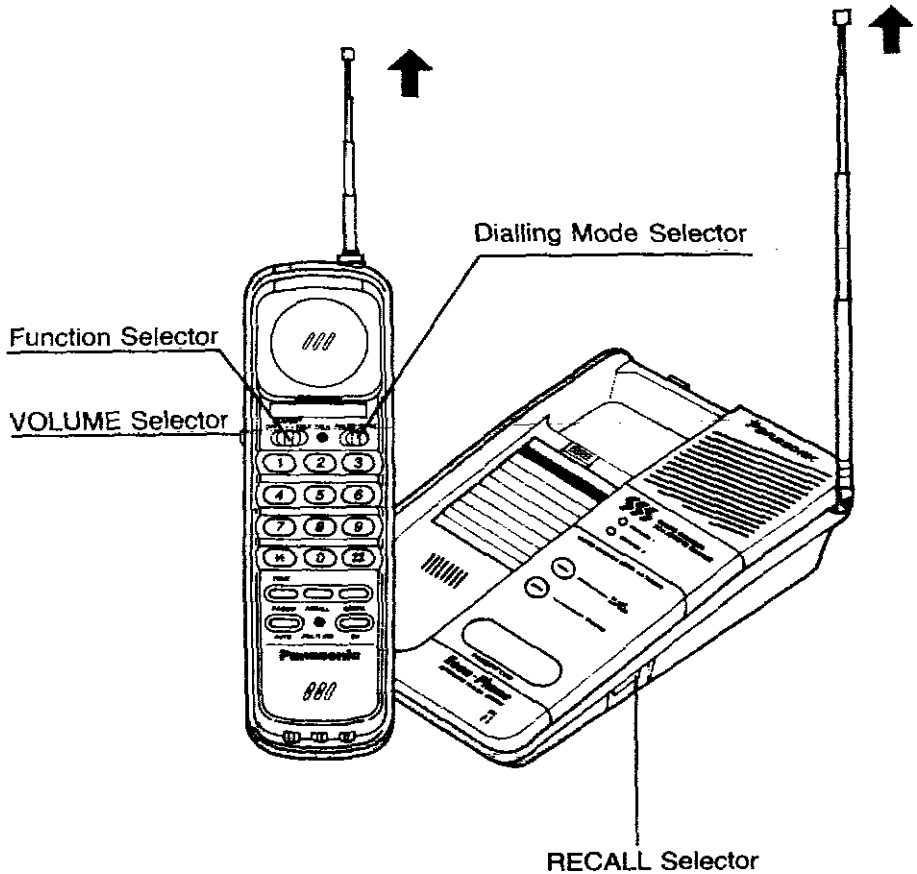

1

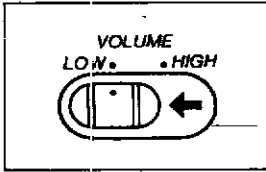

VOLUME selector:

Set the VOLUME selector to the "LOW" position.

When the other party's voice is difficult to hear, set the selector to the "HIGH" position.

2

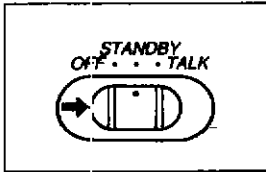

Function selector:

Set the function selector to the "STANDBY" position.

When you do not want the portable unit to ring, set the function selector to the "OFF" position.

If you do not use the unit for a long time, set the function selector to the "OFF" position.

3

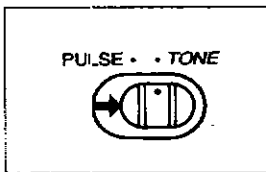

Dialling mode selector:

Set the dialling mode selector to the "TONE" position if your phone line has touch tone service. If it has rotary service, set the selector to the "PULSE" position.

4

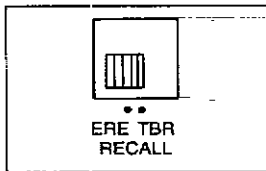

RECALL selector:

Set the RECALL selector to "E RE" or "T BR". (depending on your PBX type)
E RE...for PBX which has earth recall facility.
T BR...for PBX which has timed break register recall facility.

5

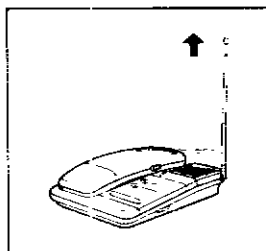

Telescopic antenna:

Extend the telescopic antenna of the base unit fully and vertically for the best performance.

Charging the battery of the portable unit

Charge the battery of the portable unit for about 10 hours before initial use or if the MULTI indicator on the portable unit flashes.

Place the portable unit on the cradle.
The CHARGE indicator light is on.

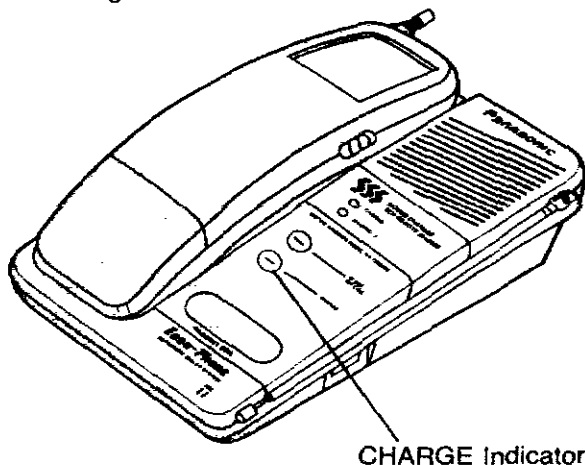

You can use the unit before 10 hours are up. But be sure to put the portable unit on the cradle after use so that it can continue to be charged.

Note:

- Even when the MULTI indicator flashes, the portable unit will still function for a short time.
- Recharging is required after a long interval, as the unit will consume some battery power gradually when not being on the cradle while in the "STANDBY" mode. If you does not use the unit for a long period of time, set the function selector to the "OFF" position.
- Clean the battery charge contacts with a soft cloth about once a month, otherwise the portable unit may not be charged properly.

Replacing the battery of the portable unit

Replace the battery if the MULTI indicator still flashes after charging it for 10 hours.

Install the new battery within 5 minutes after removing the old one, or the stored telephone numbers will be lost and reprogramming will be required.

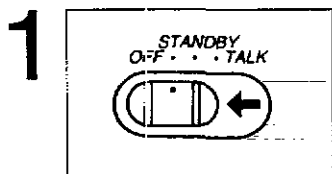

Set the function selector to the "OFF" position.

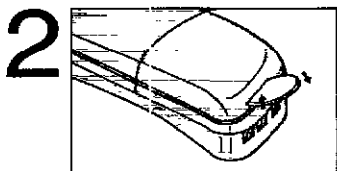

Remove the battery compartment cover using an object such as a coin.

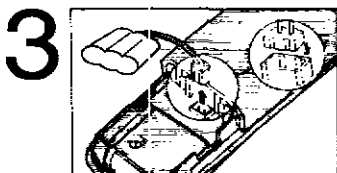

Replace the battery, and then snap the battery compartment cover into its position.

Note:

- Please use only Panasonic battery KX-A36A.
- Remember to charge the battery for 10 hours.

Making and answering calls

Telescopic antenna:

Extend the telescopic antenna of the portable unit fully for best performance when using it.

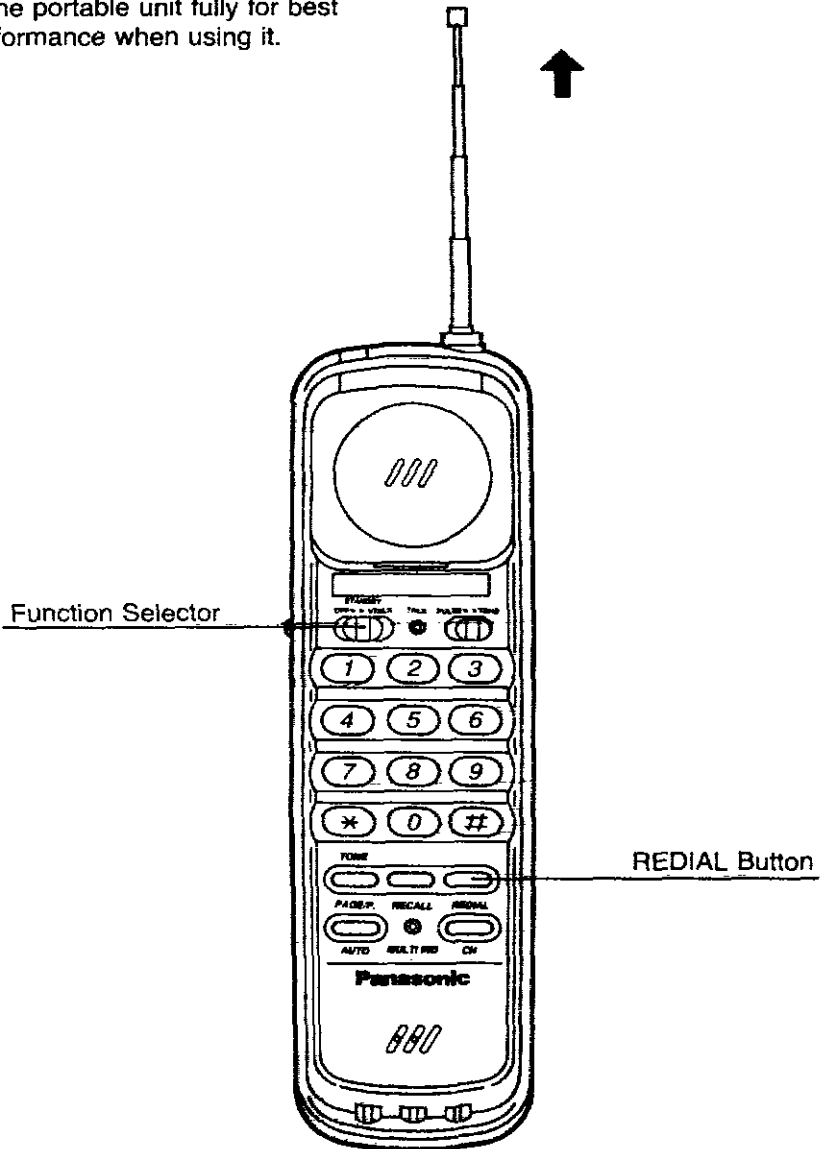

Making calls

1

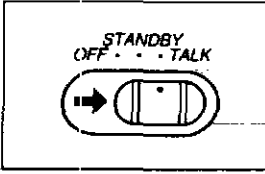

Set the function selector to the "TALK" position.

The TALK indicator light is on.

2

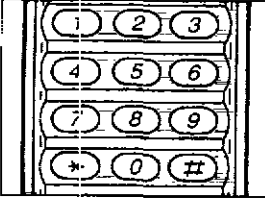

Dial the telephone number.

3

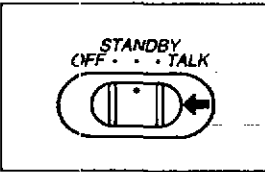

When your conversation is over, set the function selector to the "STANDBY" position.

The TALK indicator light goes out.

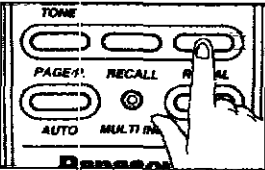

Using the REDIAL button:

The unit can redial the last dialed number. Set the function selector to the "TALK" position to get dial tone, then press the REDIAL button.

Answering calls

Be sure that the function selector is set to the "STANDBY" position.

1

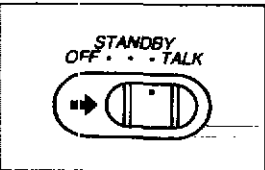

When the telephone rings, set the function selector to the "TALK" position and answer the call.

The TALK indicator light is on.

2

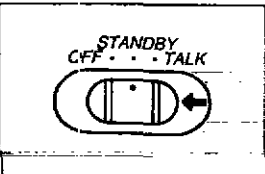

When your conversation is over, set the function selector to the "STANDBY" position.

The TALK indicator light goes out.

Automatic dialling

Each dial buttons (1 through 9) works as a memory station for automatic dialling. Each station can store a 16-digits number.

Storing telephone numbers for automatic dialling

1

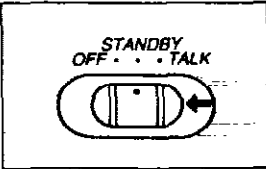

Set the function selector to the "STANDBY" position.

2

Press one of the dial buttons (1 through 9) and the AUTO button simultaneously for over one second.

The MULTI indicator light is on.

3

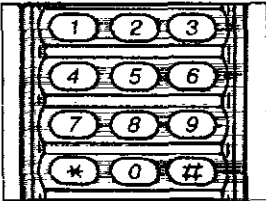

Enter the telephone number that you want to save. (up to 16-digits).

4

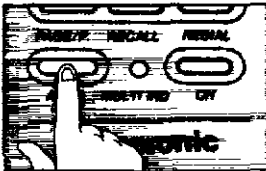

Press the AUTO button to store the number into memory.

The MULTI indicator light goes out.

Repeat from step 2 to 4, to store other telephone numbers.

Note:

- If you do not press a dialling button within 30 seconds while programming, programming mode is then cancelled. Reprogramming is necessary.
- Even while storing, you may receive a call. If you do, simply set the function selector to the "TALK" position. Programming is then cancelled and reprogramming is necessary.

Correcting an error while storing

1. Set the function selector to the "OFF" position.
The current entry is cleared and any previously stored number is unaltered.
2. Repeat the storage procedure on page 19.

Confirming a stored number

Enter the same number into the same station.
When you press the AUTO button, you hear a beep once or twice for confirmation.

Twice:

The number newly stored is the same as what was previously stored.

Once:

The number newly stored is different from the one that was previously stored. Reprogram the correct number.

Erasing a stored number

Example: Erasing a telephone number stored in memory station "2".

1. Set the function selector to the "STANDBY" position.
2. Press the AUTO button and "2" (station number to be erased) simultaneously for over one second.
3. Press the AUTO button to end the programming mode.

Automatic dialling (cont.)

Dialling

Before using automatic dialling, you must program telephone numbers into memory. (See page 19.)

1

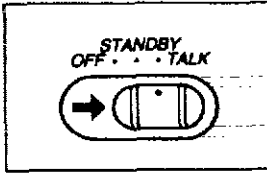

Set the function selector to the "TALK" position.

The TALK indicator light is on.

2

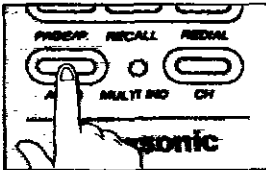

Press the AUTO button.

3

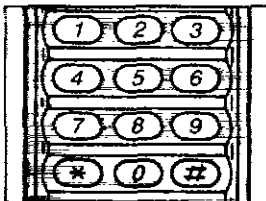

Press the station number (1 through 9) where the telephone number that you want to dial is stored.

The stored telephone number is automatically dialled.

4

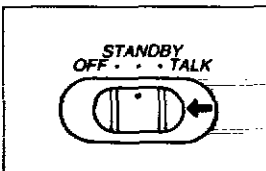

When your conversation is over, set the function selector to the "STANDBY" position to hang up.

Intercom

You can use the unit for two-way intercom between the portable unit and the base unit.

Intercom mode can be maintained for 3 minutes. After 2 minutes and 40 seconds, the alarm sounds 3 times, and then the intercom mode is terminated forcibly. Be sure to finish the intercom mode before 3 minutes are up, or the each facility of the paging and the intercom will be inoperable within 1 minute after the time out.

Paging from the base unit to the portable unit

1

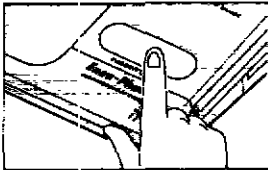

The base unit user:

Press the PAGE/INT'COM button.

The IN USE/INT'COM indicator flashes and the base unit beeps.

If the portable unit user does not answer your paging, press the PAGE/INT'COM button once again to stop the paging.

2

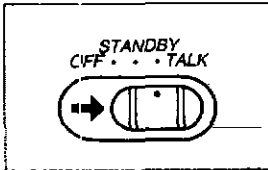

The portable unit user:

When the beep sounds, set the function selector to the "TALK" position to answer the paging.

The TALK indicator light is on.

3

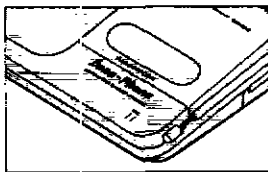

The base unit user:

Speak to the paged party through the MIC.

4

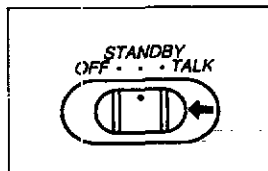

The portable unit user:

When your conversation is over, set the function selector to the "STANDBY" position to hang up.

Intercom call can only be terminated by the portable unit.

Intercom (cont.)

Paging from the portable unit to the base unit

Be sure that the function selector is set to the "STANDBY" position.

1

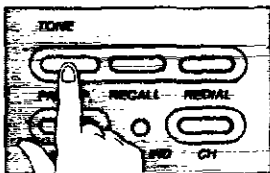

The portable unit user:

Press the PAGE/P. button.

The TALK indicator flashes and the portable unit beeps.

2

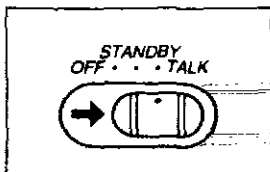

The portable unit user:

Set the function selector to the "TALK" position.

The TALK indicator light changes from flashing to a steady light, and the unit automatically switches to the intercom mode and you can speak to the paged party.

If no answer, set the function selector to the "STANDBY" position to stop the intercom mode.

3

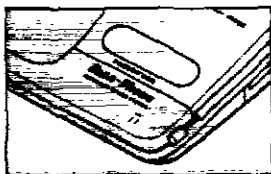

The base unit user:

When the beep sounds and the paging party's voice is heard, speak to the party through the MIC.

4

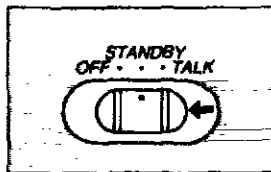

The portable unit user:

When your conversation is over, set the function selector to the "STANDBY" position.

Intercom call can only be terminated by the portable unit.

Transferring an incoming call

When you answer a call, transferring is available from the base unit to the portable unit.

This is done by connecting another telephone on the same line to the base unit.

Transferring from the base unit to the portable unit

1 The base unit user:

Pick up the handset of another telephone connected on the same line to the base unit to answer the incoming call...

2

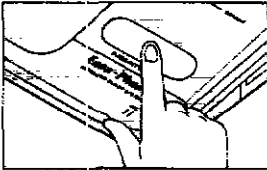

The base unit user:

Press the PAGE/INT'COM button to page the portable unit user.

The IN USE/INT'COM indicator flashes and the base unit beeps until the portable unit user sets to the "TALK" position to answer.

If the portable unit user does not answer your paging, pick up the handset of another telephone to talk to the incoming caller.

3

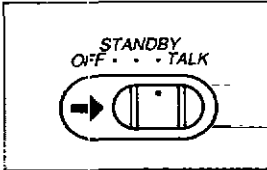

The portable unit user:

When the beep sounds, set the function selector to the "TALK" position to answer the paging, then speak to the paging party.

Transferring an incoming call (cont.)

4

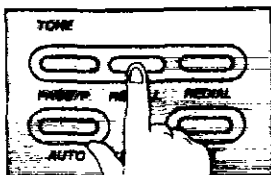

The portable unit user:

Press the RECALL button to answer the incoming call.

5

The base unit user:

After confirming the portable unit user answers the call, another telephone may be hung up.

For a three way conversation, keep the handset off-hook.

6

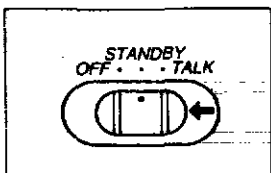

When the conversation is over, set the function selector to the "STANDBY" position to hang up.

The TALK indicator light goes out.

Note:

While having a three way conversation, the quality of the sound may be a little impaired, but it is not a fault condition.

Other features

CH button

A channel is a selected set of receiving and transmitting frequencies. You may select the clearer of 2 available channels.

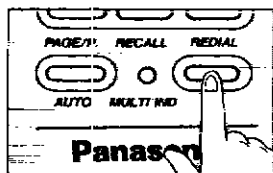

If you hear interference noise while having a conversation, press the CH button.

Each time you press the CH button, the operating channel will be switched to the other channel. The channel indicator on the base unit lights to show the selected channel.

Note:

- You can change the channel only when the portable unit is on TALK mode or INTERCOM mode.
- If the portable unit user is too far from the base unit, the CH button does not function fully. Approach the base unit.

Other features (cont.)

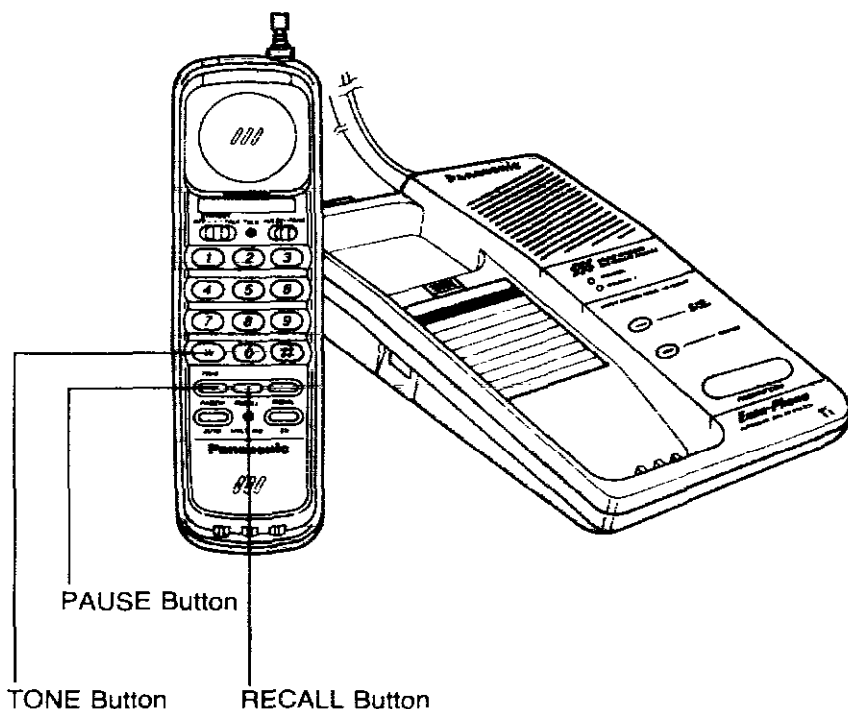

TONE button

Use the TONE button (*) when your line has rotary telephone service. Pressing it will allow you to change the dialling mode temporarily from pulse to tone mode during a dialling operation, and enter special tones and codes to operate answering machine, electronic banking services and other special services.

When you set the function selector to the "STANDBY" position to hang up, the dialling mode will be automatically returned to pulse mode.

RECALL button

The RECALL button is used to access special telephone services such as call waiting. Contact your telephone company business office for details.

Example: Call waiting

1. While having a conversation, another party calls and you hear a tone.
2. Press the RECALL button lightly.

The first conversation is placed on hold and you can answer the second call. To speak to the first caller again, press the RECALL button again. The second caller is placed on hold.

You may access some features of your host PBX using the RECALL button in a dialling operation.

PAUSE (PAGE/P.) button

When the unit is connected to your PBX's extension, dial the line access number and press the PAUSE button to access an outside line. Also when redialling, pressing the PAUSE button may be required by your host PBX.

Example: If the line access number is "9", press "9" then the PAUSE button.

Then dial the telephone number.

Press once
(3.5-seconds pause)
Press twice
(7-seconds pause)

Combination dialling

The following combinations of dialling methods can be used.

- Manual dialling and automatic dialling
- Pulse and Tone dialling
- Plural memory stations

Mercury feature

When you use the Mercury company service, you need to contract with the Mercury company. When you make a call using the Mercury company service, dial the access number and authorized code in succession before the telephone number.

You can store the access number and authorized code, your telephone number into memory station. Contact your Mercury company for details.

To store Mercury (MCL) code

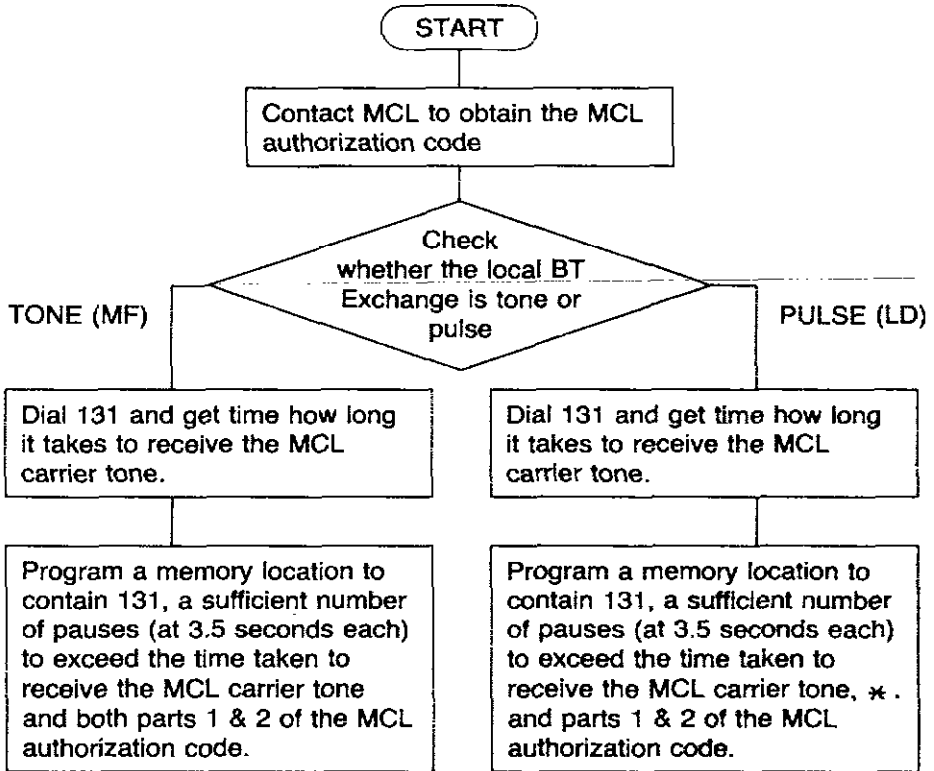

To dial using MCL

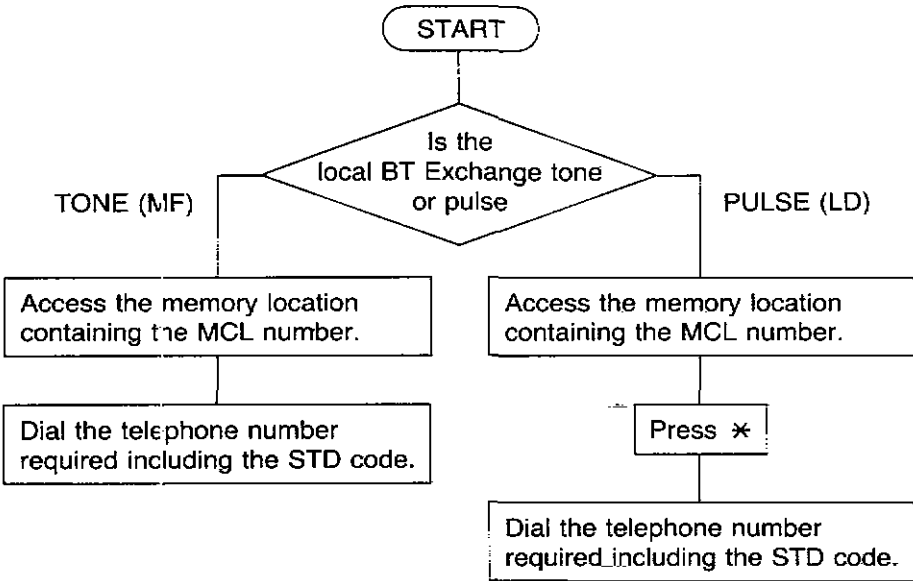

Battery installation of the AC adaptor

You can use the unit even in the event of a power failure by installing optional batteries into the AC adaptor.

Nine AA, R6 or UM-3 size batteries serve as the power source to use while in power failure.

1

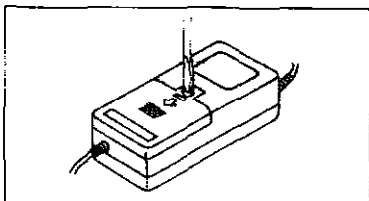

Loosen the screw.

2

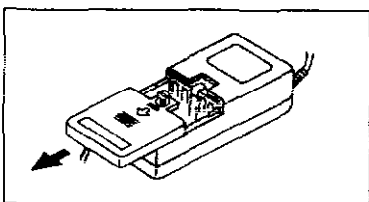

Open the battery compartment as shown.

3

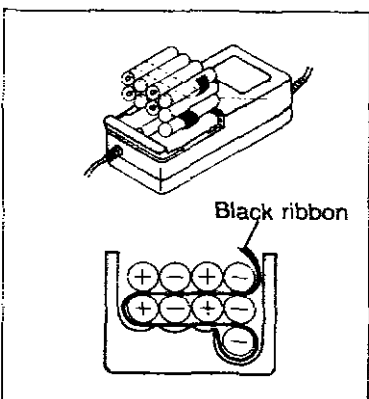

Insert nine AA, R6 or UM-3 size batteries in the proper order as indicated observing the correct polarity.

Set the black ribbon between the batteries as shown, which helps you to take out the batteries easily.

4

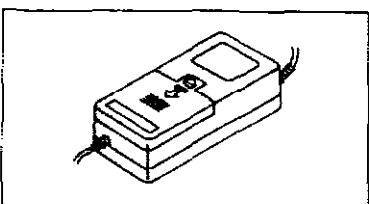

Close the battery compartment cover. Tighten the screw.

You had better renew the batteries annually as a matter of routine. You should also replace the batteries which have been used during a power failure with new ones.

Wall mounting

This unit can be mounted on the wall using the washers and screws provided.

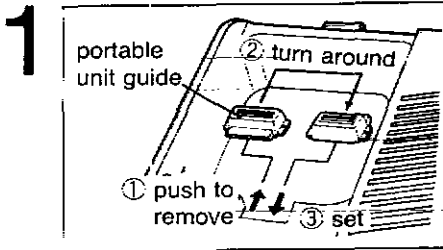

Turn around the portable unit guide.

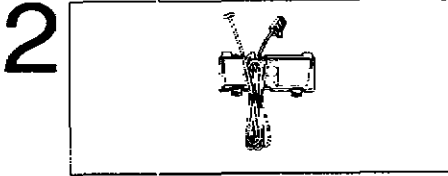

Bundle the telephone line cord and hang it as shown.

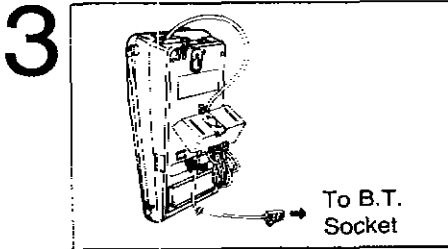

Insert the hook of the wall mounting adaptor into the hole of the unit, then push it in the direction of arrow.

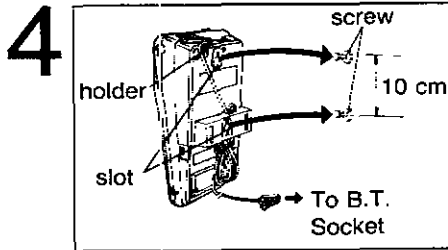

Install the screws and washers using the wall template indicated below, and hang the unit on the screws.

Wall Template

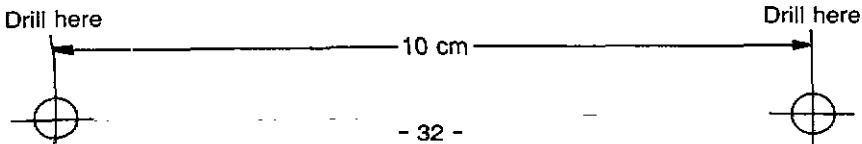

Troubleshooting guide

Problem	Cause & Remedy
The unit does not work.	<ul style="list-style-type: none">•The battery of the portable unit becomes weak. Charge the battery fully. (See page 15.)•The connection of the unit has been made improperly. (See page 11.)•You are too far from the base unit. Move closer to the base unit.•The function selector is set to the "OFF" position. Set to the "TALK" position.
The portable unit does not ring.	<ul style="list-style-type: none">•The function selector is set the "OFF" position. Set to the "STANDBY" position.
Sound flutters or fades.	<ul style="list-style-type: none">•You are too far from the base unit. Move closer to the base unit.•The telescopic antenna is not fully extended.
The MULTI indicator flashes.	<ul style="list-style-type: none">•Charge the battery fully. (See page 15.)
I charged the battery for 10 hours, but the MULTI indicator flashes after a few telephone calls.	<ul style="list-style-type: none">•It is time to change the battery. Please replace it with a new one. (See page 16.)
While operating the unit the AC adaptor feels warm.	<ul style="list-style-type: none">•This is in normal condition.

STAMP
REQUIRED

Panasonic Business Systems U.K.

WILLOUGHBY RD.
BRACKNELL, BERKSHIRE
RG12 4FP



POST CARD

STAMP
REQUIRED

**The Telephone Manager
British Telecom Sales Department**

..... Area
.....
.....

MODEL No.
KX-T3826BE

SERIAL No.

CUSTOMERS NAME etc. (BLOCK CAPITALS)

DEALERS

TELEPHONE No.

DATE OF PURCHASE

WE WOULD BE GRATEFUL IF YOU WOULD COMPLETE THE FOLLOWING BEFORE RETURNING THIS CARD FOR REGISTRATION.

Male Female

Age ()

1. WHAT TYPE OF STORE?

- RADIO-TV GENERAL
- H.F. AUDIO SPECIALIST
- TELEPHONE SPECIALIST
- DEPARTMENT
- MAIL ORDER
- OTHER

2. WHEN YOU PURCHASED THIS UNIT DID YOU COMPARE WITH OTHER MODELS?

YES NO

MAKE
MODEL
PRICE

3. WHERE DO YOU PLAN TO USE?

- LIVING ROOM
- DINING ROOM
- OFFICE
- BEDROOM
- OTHER

4. HOW DID YOU LEARN OF THIS PRODUCT?

- AD. ON MAGAZINE/PAPER
- EDITORIAL IN MAGAZINE
- AD. ON HOARDING
- AD. ON T.V. OR RADIO
- DISPLAY IN STORE
- CATALOGUE
- OTHERS

5. WHAT PERSUADED YOU TO BUY THIS UNIT?

- TRUST IN BRAND NAME
- HIGH QUALITY
- PRICE
- DEALERS RECOMMENDATION
- FRIENDS RECOMMENDATION
- TECHNICAL SPECIFICATION
- APPEARANCE AND DESIGN
- SIMPLE CONTROLS

6. IS THIS UNIT YOUR

- FIRST OWNED?
- REPLACEMENT?

7. HOW DO YOU RATE THIS MODEL ON? THE SCALE FOR

- | | | | |
|---------------------|-----------|---------|---------|
| | EXCELLENT | GOOD | POOR |
| (a) PERFORMANCE | ←-----→ | ←-----→ | ←-----→ |
| (b) FEATURES | ←-----→ | ←-----→ | ←-----→ |
| (c) DESIGN | ←-----→ | ←-----→ | ←-----→ |
| (d) VALUE VS. PRICE | ←-----→ | ←-----→ | ←-----→ |

8. IF FOR BUSINESS USE, HOW MANY EMPLOYEES ARE THERE IN YOUR COMPANY?

- UNDER 10
- UNDER 50
- UNDER 100
- 100+

9. YOUR COMMENTS IF ANY

Registered No. 1485987

CONNECTION REQUEST

For B.T. owned wiring:

The following subscriber requests you to install a wall socket to enable connection of a "direct exchange line"/P.B.X. extension line for the Panasonic KX-T3826BE Telephone.

Approval Number S/1010/3/M/502120

Subscriber _____

Address _____

Telephone Number _____

Signature _____

*Delete if not required.

For wiring not owned by B.T.

Request should be made to the Authorised maintainer of the PBX for extension wiring and socket installation within 14 days expiry of the period or notice will allow another installer to be employed

GUARANTEE CONDITIONS OF GUARANTEE

This guarantee is in addition to and does not in any way affect any statutory or other rights of consumer purchasers.

If within the applicable guarantee period, the appliance proves to be defective by reason of faulty design, workmanship or materials, we undertake subject to the following conditions to have the defective appliance (or any part or parts thereof) repaired or replaced free of charge.

1. The appliance shall have been purchased and used solely within the UK and in accordance with standard operating instructions and the technical and/or Safety Standards required in the UK.
2. The purchaser will within 7 days of purchase complete the included card and send it to us for registration. Failure to return such card could result in delay in providing the guarantee service.
3. The appliance should be returned together with this guarantee and proof of date of purchase promptly on being found defective at the purchaser's risk and expense to the authorized dealer from whom the appliance was purchased or to the nearest authorized dealer. All enquiries must be through such dealers.
4. This guarantee shall not apply to damage caused through fire, accident, lightning, misuse, wear and tear, neglect, incorrect adjustment or repair, to damage caused through installation, adaption, modification or use in an improper manner or inconsistent with the technical and/or safety standards required in the country where this appliance is used, or to damage occurred during transit to or from the purchaser.
5. If at any time during the guarantee period any part or parts of the appliance are replaced with a part or parts not supplied or approved by us or of an objective quality safe and suitable for the appliance, or the appliance has been dismantled or repaired by any person not authorized by us, we shall have the right to terminate this guarantee in whole or in part immediately without further notice.
6. The purchaser's sole and exclusive remedy under this guarantee against us is for the repair or replacement of the appliance or any defective part or parts and no other remedy, including, but not limited to, incidental or consequential damage or loss of whatsoever nature shall be available to the purchaser.
7. This guarantee shall not apply to cassette tapes, batteries and any other items of limited natural life.
8. Our decision on all matters relating to complaints shall be final. Any appliance or defective part which has been replaced shall become our property.
9. The guarantee period applicable to this product shall be 12 months.

Please keep this Operating Instructions with your receipt.

Panasonic Business Systems U.K.

RECEIPT No.	DATE OF PURCHASE
MODEL No. KX-T3826BE	SERIAL No.

109

Matsushita Electric Industrial Co., Ltd.
Central P. O. Box 288, Osaka 530-91, Japan

Printed in Japan

PQQX6197YA S0691G5043N (X