

# Panasonic

Proprietary Telephone  
for Electronic Modular Switching Systems

MODEL NO. **KX-T7020E**

## Reference Manual

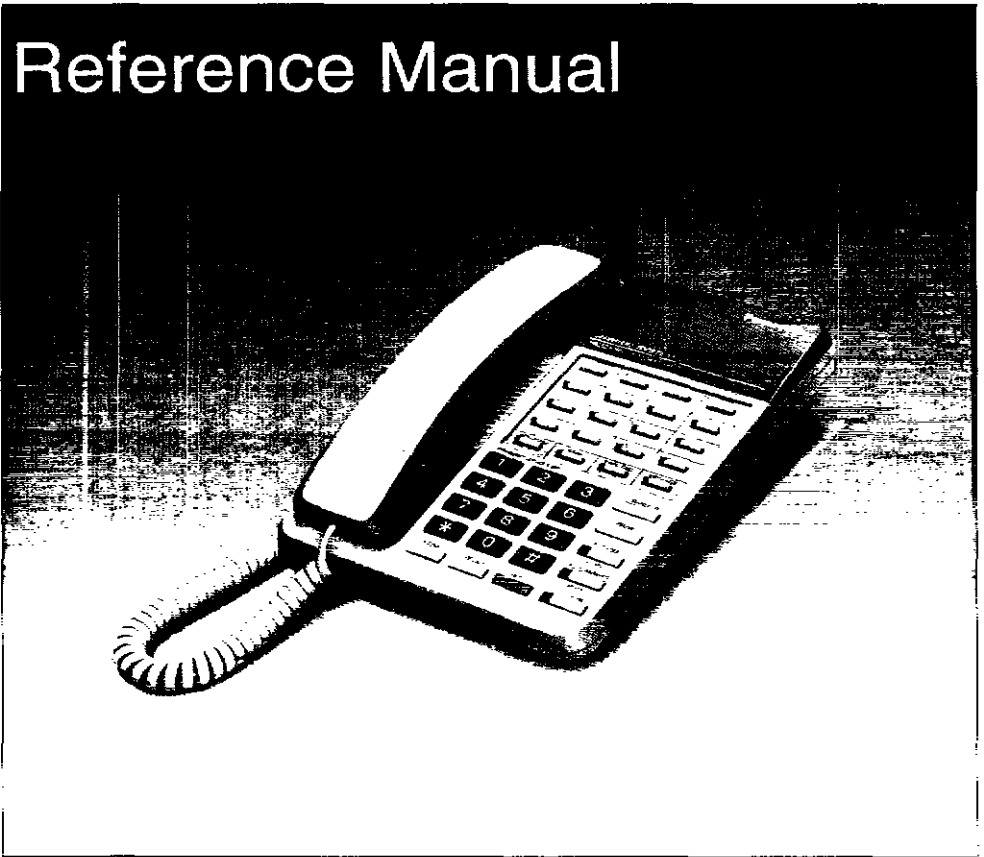

The KX-T7020E is compatible with the Panasonic Electronic Modular Switching Systems.

Please read before using.

## Cautions

- The apparatus is designed to be installed and operated under controlled conditions of ambient temperature and a relative humidity not greater than 60%.
- Avoid installing the apparatus in damp or humid environments, such as bathrooms or swimming pools.
- 999 or 112 can be dialled on the apparatus after accessing the CO line for the purpose of making outgoing calls to the BT emergency service.
- During dialling, this apparatus may tinkle the bells of other telephones using the same line. This is not a fault and we advise you not to call Fault Repair Service.
- If the apparatus does not operate properly, disconnect the unit from the extension line cord and then connect again.
- **Power failure transfer**

Even if the KX-T7020E is connected to telephone line, it will not operate during a power failure.

**For further details, see the Installation Manual.**

**APPROVED** for connection to telecommunication systems specified in the instructions for use subject to the conditions set out in them.

S/1010/3/M/502123

# Contents

Connection .....	4
Initial Setting .....	5
Location of Controls .....	6
Feature Descriptions .....	8
Operating Instructions	
for KX-T30810BE, KX-T61610BE or KX-T123210BE .....	9
for KX-T30810BE or KX-T61610BE .....	10
for KX-T123210BE .....	11
Installing the Card Holder .....	13
Wall Mounting .....	14
Others .....	15

This Telephone Set will not operate on the original version of KX-T30810BE. All the features described in this manual are available on the upgraded version of KX-T123210BE. Some of the features are not available on the other models (original version of KX-T61610BE; KX-T123210BE and upgraded version of KX-T30810BE/KX-T61610BE). For further details, please see the leaflet of "Information."

## Connection

Connect as shown.

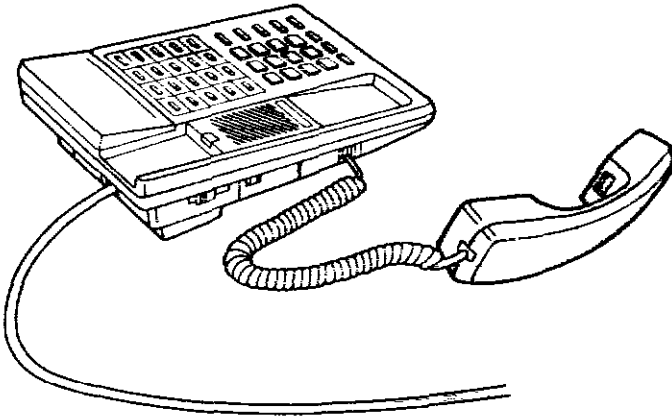

### Included Accessories

Card holder with memory station card ..... one

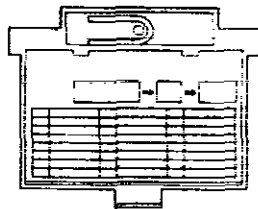

## Initial Setting

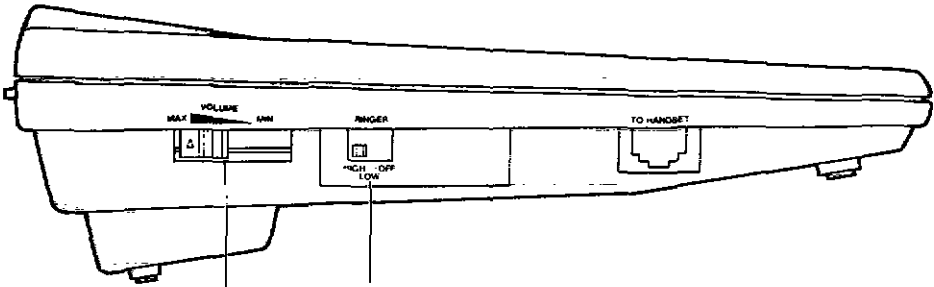

### Ringer Volume Selector :

HIGH : The ringing sound will be loud.

LOW : The ringing sound will be soft.

OFF : The telephone will not ring.

### VOLUME Control :

MAX : The volume will be loud.

MIN : The volume will be soft.

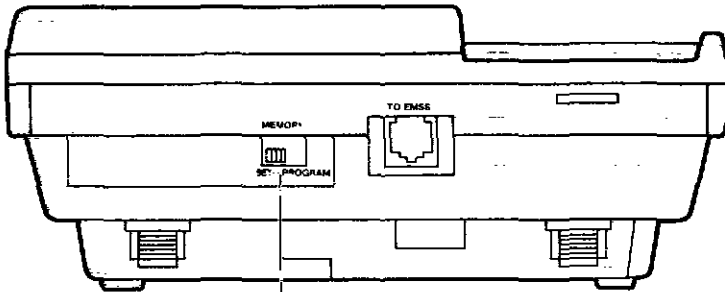

### MEMORY Switch :

Set to "SET."

For station programming, set to "PROGRAM."

## Location of Controls

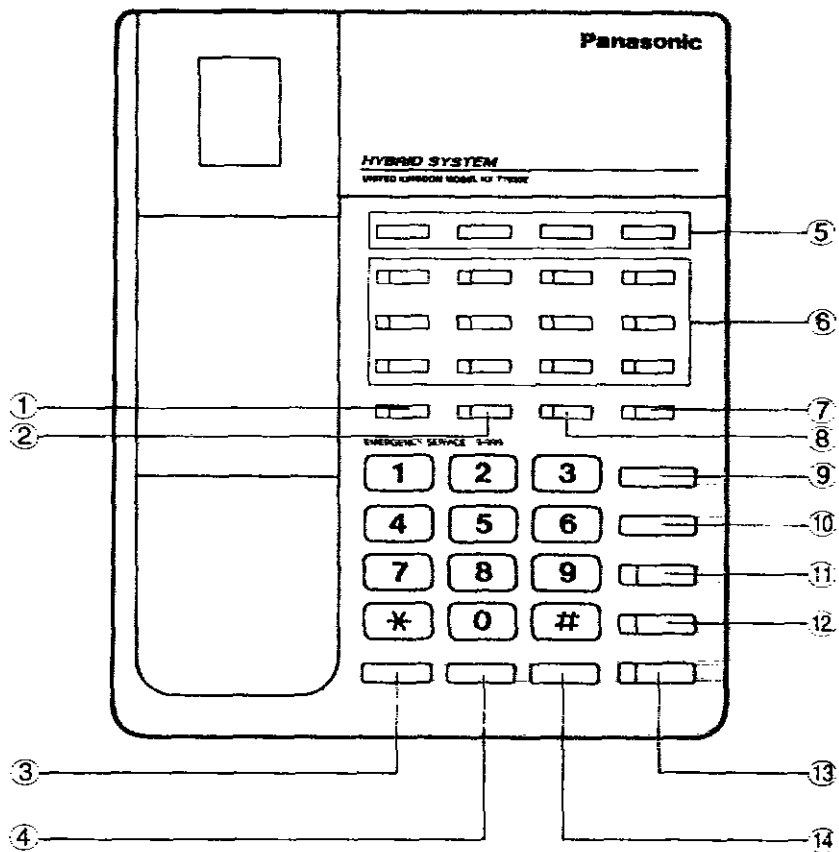

- KX-T7020E is designed especially for the visually handicapped operators: TRANSFER button, SP-PHONE button, and dial key "5" of KX-T7020E have a raised pip to aid them to locate the buttons and keys.

- ① **INTERCOM Button and Indicator:**  
Used to make or receive an intercom call.
- ② **CONFERENCE Button and Indicator:**  
Used to perform a three-party conference.
- ③ **REDIAL Button:**  
Used to redial the last dialled number.
- ④ **RECALL Button:**  
Used to send a recall signal to a Central Office.
- ⑤ **Programmable Feature Buttons:**  
Can be used as One-Touch Dialling buttons or system feature buttons.
- ⑥ **Flexible CO Buttons and Indicators:**  
Can be used as CO, Direct Station Selection or One-Touch Dialling buttons.
- ⑦ **Flexible MESSAGE Button and Indicator:**  
Can be used as Message Waiting, Direct Station Selection or a One-Touch Dialling button.
- ⑧ **FWD/DND Button and Indicator:**  
Used to set or cancel the Call Forwarding or Do Not Disturb feature.
- ⑨ **TRANSFER Button:**  
Used to transfer an outside or intercom call to another extension.
- ⑩ **PAUSE Button:**  
Used to insert a pause in a speed dial number.
- ⑪ **AUTO DIAL/STORE Button and Indicator:**  
Used before dialling a speed dial number. / In "PROGRAM" mode, used to store a station programming procedure in the memory at the end of operation.
- ⑫ **AUTO ANSWER/MUTE Button and Indicator:**  
Used to answer an intercom call automatically. / Used to hear the other party without them hearing you in handsfree mode.
- ⑬ **SP-PHONE Button and Indicator:**  
Used to make or receive a phone call without using the handset.
- ⑭ **HOLD Button:**  
Used to place a call on hold.

These Operating Instructions describe basic features and operations of the KX-T7020E used with a Panasonic Electronic Modular Switching System: KX-T30810BE, KX-T61610BE or KX-T123210BE.

## Feature Descriptions

### ■ Automatic Line Access

Allows you to select an unoccupied outside line automatically to make an outgoing call.

### ■ Call Forwarding (FWD)

Calls to your telephone set are automatically forwarded to another preset extension or outside party. The following types are available:

#### – FWD — All Calls

All calls are forwarded to another extension.

#### – FWD — Busy or No Answer

Calls are forwarded to another extension when you are busy or do not answer.

### ■ Conference

Allows you to make a three-inside-party conference.

### ■ Dial Call Pickup

Allows you to answer a call to any extension in your pickup group.

### ■ Directed Call Pickup

Allows you to answer a call from any extension.

### ■ Do Not Disturb

Your telephone set will not receive incoming calls.

### ■ Flexible CO Button

Can be used as CO button with CO number different from the default or as DSS or One-Touch Dialling button.

### ■ Flexible MESSAGE Button

Can be used as Message Waiting, DSS or One-Touch Dialling button

### ■ Individual Line Access

Allows you to select an outside line directly to make an outgoing call.

### ■ Last Number Redial

Redials the last dialed number.

### ■ One-Touch Dialling

Allows you to dial a stored phone number by pressing one button.

### ■ Paging

There are four paging types as follows:

- All Extensions
- Group
- External
- All Extensions and External

### ■ Paging and Transfer

Allows you to transfer a call to a paged person.

### ■ Paging Answer

Allows you to answer a page.

### ■ System Speed Dialling

Allows you to dial a stored phone number quickly



# Operating Instructions for KX-T30810BE, KX-T61610BE or KX-T123210BE

## NOTE

<b>Off-hook:</b>	Lift the handset or press the SP-PHONE button.
<b>On-hook:</b>	Replace the handset or press the SP-PHONE button.
<b>Line access code:</b>	9 or 81 through 83 for KX-T30810BE 9 or 81 through 86 for KX-T61610BE 9 or 81 through 88 for KX-T123210BE

## ■ Automatic Line Access

- Off-hook.
- Dial **9 + phone number**.

## ■ Call Transfer to Extension

### - Screened

- While having a conversation,
- Press **TRANSFER** button.
  - Dial **extension number**, or press **DSS** button (if assigned).
  - Wait for an answer and announce.
  - On-hook.

### - Unscreened

- While having a conversation,
- Press **TRANSFER** button.
  - Dial **extension number**, or press **DSS** button (if assigned).
  - On-hook.

## ■ Conference

- When talking with a party,
- Press **CONF** button. (The first party is placed on hold.)
  - Dial the **next party's number**.
  - Talk to the next party.
  - Press **CONF** button. (A three-inside-party conference is now established.)

## ■ Flexible CO Button

- Before programming,*
- ◆ *Be sure your telephone is on-hook.*
  - ◆ *Set the MEMORY switch to "PROGRAM."*
- To assign another CO number
- Press **CO** button.
  - Dial **0**.

- Dial **new CO number**.
  - **1** through **3** for KX-T30810BE
  - **1** through **6** for KX-T61610BE
  - **01** through **12** for KX-T123210BE
- Press **STORE** button.

### - To assign DSS function

- Press **CO** button.
- Dial **1 + extension number**.
- Press **STORE** button.

### - To assign One-Touch Dialling function

- Press **CO** button.
- Dial **2 + line access code + phone number**.
- Press **STORE** button.

*After programming,*

- ◆ *Return the MEMORY switch to "SET."*

## ■ Flexible MESSAGE Button

*Before programming,*

- ◆ *Be sure your telephone is on-hook.*
- ◆ *Set the MEMORY switch to "PROGRAM."*

### - To assign DSS function

- Press **MESSAGE** button.
- Dial **1 + extension number**.
- Press **STORE** button.

### - To assign One-Touch Dialling function

- Press **MESSAGE** button.
- Dial **2 + line access code + phone number**.
- Press **STORE** button.

*After programming,*

- ◆ *Return the MEMORY switch to "SET."*

## ■ Hold

- Press **HOLD** button.

## Operating Instructions for KX-T30810BE, KX-T61610BE or KX-T123210BE (Contd.)

- Retrieving an intercom call at the holding extension
  - Press **INTERCOM** button.
- Retrieving a CO call at the holding extension
  - Press the green flashing **CO** button.

### ■ Individual Line Access

- Off-hook.
- Press **CO** button.
- Dial **phone number**.

### ■ Intercom Calling

- Off-hook.
- Dial **extension number**, or press **DSS** button (if assigned).

### ■ Last Number Redial

- Off-hook.
- Press **REDIAL** button.

### ■ One-Touch Dialling

#### Storing a phone number

*Before programming,*

- ◆ *Be sure your telephone is on-hook.*
- ◆ *Set the MEMORY switch to "PROGRAM."*
  - Press a **programmable feature** button.
  - Dial **line access code + phone number**.
  - Press **STORE** button.

*After programming,*

- ◆ *Return the MEMORY switch to "SET."*

#### Dialling

- Off-hook.
- Press a **programmable feature** button.

### ■ System Speed Dialling

- Off-hook.
- Press **AUTO DIAL** button.
- Dial a **speed dial number**.

## Operating Instructions for KX-T30810BE or KX-T61610BE

### ■ Call Forwarding - All Calls Setting

- Off-hook.
- Press **FWD/DND** button.
- Dial **extension number**.
- On-hook.

#### Canceling

- Off-hook.
- Press **FWD/DND** button.
- Dial **0**.
- On-hook.

### ■ Dial Call Pickup

- Off-hook.
- Dial **50**.
- Hear confirmation tone.
- Talk.

### ■ Directed Call Pickup

- Off-hook.
- Dial **5 + extension number**.
- Hear confirmation tone
- Talk.

### ■ Do Not Disturb

#### Setting

- Off-hook
- Press **FWD/DND** button.
- Dial **20**.
- On-hook.

#### Canceling

- Off-hook.
- Press **FWD/DND** button.
- Dial **0**.
- On-hook.

### ■ Paging

- **Paging All Extensions (Internal Page)**
  - Off-hook.
  - Dial **44**.
  - Hear confirmation tone.
  - Page.

## Operating Instructions for KX-T30810BE or KX-T61610BE (Contd.)

## Operating Instructions for KX-T123210BE

### - Group Paging (Internal Page)

- Off-hook.
- Dial **group access number**.
  - **45**: for Group 1
  - **46**: for Group 2
  - **47**: for Group 3  
(KX-T61610BE only)
  - **48**: for Group 4  
(KX-T61610BE only)
- Hear confirmation tone.
- Page.

### - External Paging

- Off-hook.
- Dial **43**.
- Hear confirmation tone.
- Page.

### ■ Paging and Transfer

While having a conversation,

- Press **TRANSFER** button.
- Dial **paging access number**:
  - **44**: for Paging All Extensions
  - **43**: for External Paging
  - **45**: for Group 1
  - **46**: for Group 2
  - **47**: for Group 3  
(KX-T61610BE only)
  - **48**: for Group 4  
(KX-T61610BE only)
- Hear confirmation tone.
- Page.
- Wait for an answer.
- On-hook.

### ■ Paging Answer

- Off-hook.
- Dial **51**.
- Hear confirmation tone.
- Talk.

### ■ Call Forwarding

#### Setting

- **All Calls/Busy or No Answer**
  - Off-hook.
  - Press **FWD/DND** button.
  - Dial **feature access code**:
    - **1**: for All Calls
    - **2**: for Busy or No Answer
  - Dial **extension number + #**.
  - On-hook.

#### Cancelling

- Off-hook.
- Press **FWD/DND** button.
- Dial **0 + #**.
- On-hook.

### ■ Call Park

#### - To park a call

- While having a conversation,
  - Press **HOLD** button.
  - Dial **50 + parking zone number**  
(**0** through **9**).
  - On-hook.

#### - To retrieve a parked call

- Off-hook.
- Dial **51**.
- Dial **parking zone number**.
- Hear confirmation tone.
- Talk.

### ■ Dial Call Pickup

- Off-hook.
- Dial **40**.
- Hear confirmation tone.
- Talk.

### ■ Directed Call Pickup

- Off-hook.
- Dial **4 + extension number**.
- Hear confirmation tone.
- Talk.

## Operating Instructions for KX-T123210BE (Contd.)

### ■ Do Not Disturb

#### Setting

- Off-hook.
- Press **FWD/DND** button.
- Dial **4 + #**.
- On-hook.

#### Cancelling

- Off-hook.
- Press **FWD/DND** button.
- Dial **0 + #**.
- On-hook.

### ■ Paging

- **All Extensions (Internal Page)**
  - Off-hook.
  - Dial **330**.
  - Hear confirmation tone.
  - Page.
- **Group (Internal Page)**
  - Off-hook.
  - Dial **33 + extension group number** (1 through 8).
  - Hear confirmation tone.
  - Page.
- **External**
  - Off-hook.
  - Dial **32**.
  - Dial **pager access number**.
    - **0**: for pagers 1 & 2
    - **1**: for pager 1
    - **2**: for pager 2
  - Hear confirmation tone.
  - Page.
- **All Extensions and External**
  - Off-hook.
  - Dial **32\*** or **33\***.
  - Hear confirmation tone.
  - Page.

### ■ Paging and Transfer

While having a conversation,

- Press **TRANSFER** button.
- Dial **paging access number**:
  - **330**: for All Extensions

- **331 through 338**:
  - for Group 1 through 8
- **320 through 322**:
  - for External pager: all or 1 or 2
- **32\*** or **33\***:
  - for All Extensions and External
- Hear confirmation tone.
- Page.
- Wait for an answer.
- On-hook.

### ■ Paging Answer

- **To answer an internal page from the built-in speaker**
  - Off-hook.
  - Dial **43**.
  - Hear confirmation tone.
  - Talk.
- **To answer an external page**
  - Off-hook.
  - Dial **41**.
  - Dial **pager access number**.
    - 1: for pager 1
    - 2: for pager 2
  - Hear confirmation tone
  - Talk.

## Installing the Card Holder

- 1** Match the marks ( ▶ ) on the card holder and on the slide rails on the unit.

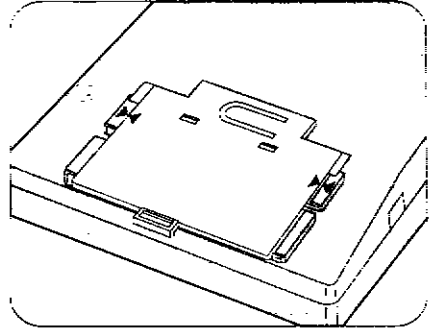
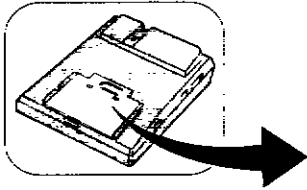

- 2** Push two shaded portions slightly and insert the edges of the holder under the slide rails and then slide down in direction of arrow "A."

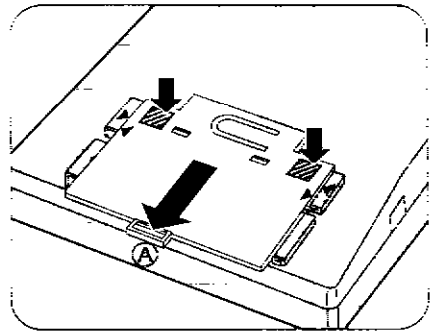

### Removing the card holder

Push the card holder in the direction of arrow "B" while keeping the tip of the holder pulled in the direction of arrow "C," to take off the holder.

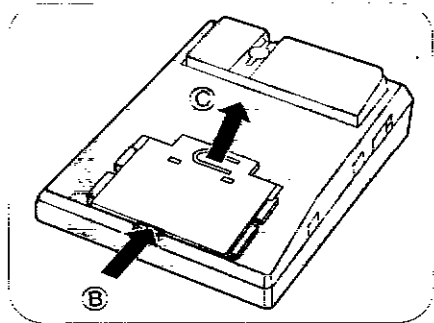

## Wall Mounting

**1** Turn around the handset hook.

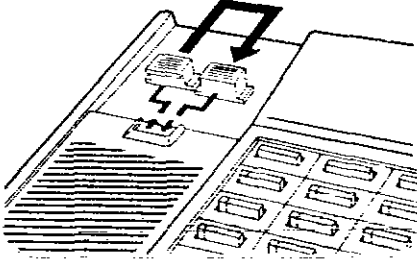

**4** Place the stand.

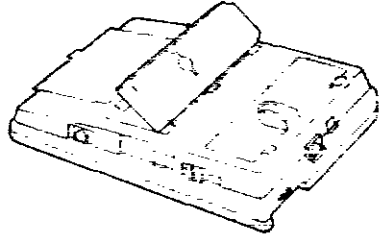

**2** Remove the attaching stand.

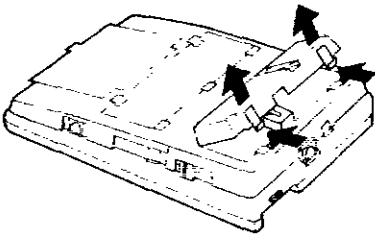

**5** Mount the unit on the wall phone plate.

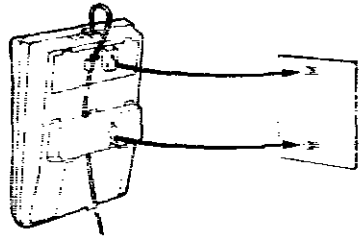

**3** Rotate the stand in the direction of the arrow.

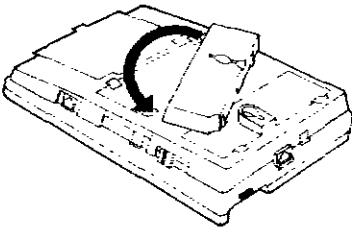

To temporarily place the handset down during a conversation, hook as shown.

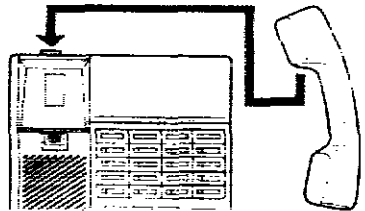

## Others

If there is any trouble, disconnect the unit from the extension line and connect a known working phone. If the known working phone operates properly, do not reconnect the unit to the extension line until the trouble has been repaired. If the known working telephone does not operate properly, check the Electronic Modular Switching System.

Keep the unit away from heating appliances and electrical noise generating devices such as fluorescent lamps and motors.

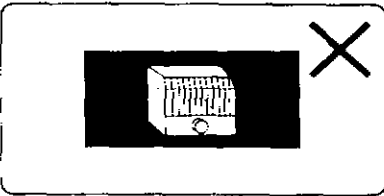

The unit should be kept free of dust, moisture and vibration, and should not be exposed to direct sunlight.

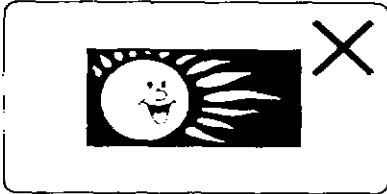

Do not use benzine, thinner, or the like, or any abrasive power to clean the cabinet. Wipe it with a soft cloth.



- This unit is capable of being used in conjunction with hearing aids fitted with inductive coil pick-ups. The handset should be held as for normal conversation. For operation the hearing aid should be set to it's "T" position or as directed in the operating instructions for the hearing aid.



- KX-T7020E is designed to aid the visually handicapped to locate dial keys and buttons.

### **WARNING:**

**TO PREVENT FIRE OR SHOCK HAZARD, DO NOT EXPOSE THIS PRODUCT TO RAIN OR ANY TYPE OF MOISTURE.**

Do not use any handset other than the Panasonic handset for model KXT 7020E

180

**Warning**

This is a Class A Product. In a domestic environment this product may cause radio interference in which case the user may be required to take adequate measures.



89/336/EEC  
92/31/EEC  
93/68/EEC

**Panasonic Business Systems U.K.**

Panasonic House, Willoughby Road, Bracknell,  
Berkshire RG12 4FP

Printed in the United Kingdom

**PQQX10146YC** S0293M2085J(IS)