

I **N** **S** **T** **A** **L** **L** **A** **T** **I** **O** **N** **M** **A** **N** **U** **A** **L**

*Please read this manual before connecting
the Voice Processing System.*

MODEL

KX-TVP100E

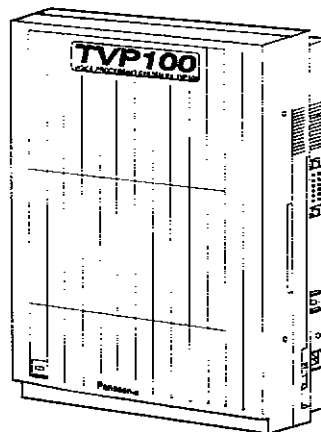

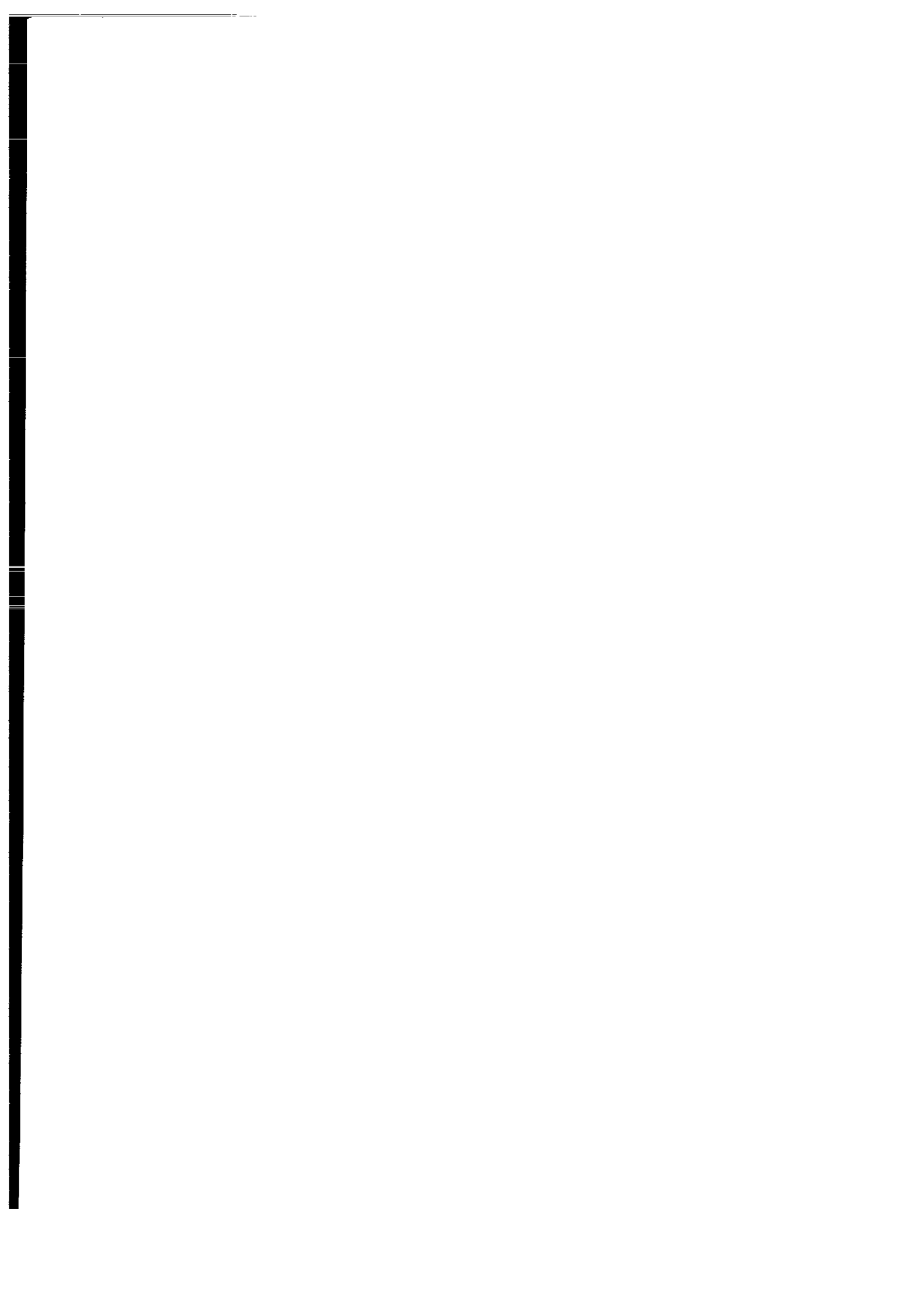

Precaution

WARNING

THIS UNIT MAY ONLY BE INSTALLED AND SERVICED BY QUALIFIED SERVICE PERSONNEL.

WHEN A FAILURE OCCURS WHICH RESULTS IN THE INTERNAL PARTS BECOMING ACCESSIBLE, DISCONNECT THE POWER SUPPLY CORD IMMEDIATELY AND RETURN THIS UNIT TO YOUR DEALER.

DISCONNECT THE TELECOM CONNECTION BEFORE DISCONNECTING THE POWER CONNECTION PRIOR TO RELOCATING THE EQUIPMENT, AND RECONNECT THE POWER FIRST.

THIS UNIT IS EQUIPPED WITH AN EARTHING CONTACT PLUG. FOR SAFETY REASONS THIS PLUG MUST ONLY BE CONNECTED TO AN EARTHING CONTACT SOCKET WHICH HAS BEEN INSTALLED ACCORDING TO REGULATIONS.

THE POWER SOCKET WALL OUTLET SHOULD BE LOCATED NEAR THIS EQUIPMENT AND BE EASILY ACCESSIBLE.

THE POWER CARD/MAINS PLUG IS USED AS THE DISCONNECT DEVICE.

- NOTE**
- This Installation Manual does not show complete model numbers that indicate the country where your models should be used. The model number of your unit is found on the label affixed to the unit.

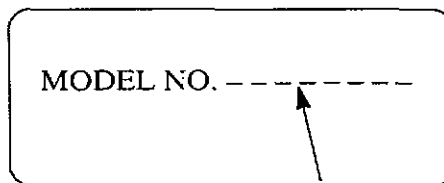

(label)

CE
73/23/EEC
89/336/EEC
92/31/EEC
93/68/EEC

APPROVED for connection to telecommunication systems specified in the instructions for use subject to the conditions set out in them.

606168

Precaution

FOR YOUR SAFETY PLEASE READ THE FOLLOWING TEXT CAREFULLY.

This appliance is supplied with a moulded three pin mains plug for your safety and convenience.

A 13 amp fuse is fitted in this plug.

Should the fuse need to be replaced please ensure that the replacement fuse has a rating of 13 amps and that it is approved by ASTA or BSI to BS1362.

Check for the ASTA mark  or the BSI mark  on the body of the fuse.

If the plug contains a removable fuse cover you must ensure that it is refitted when the fuse is replaced.

If you lose the fuse cover the plug must not be used until a replacement cover is obtained.

A replacement fuse cover can be purchased from your local Panasonic Dealer.

IF THE FITTED MOULDED PLUG IS UNSUITABLE FOR THE SOCKET OUTLET IN YOUR HOME THEN THE FUSE SHOULD BE REMOVED AND THE PLUG CUT OFF AND DISPOSED OF SAFELY. THERE IS A DANGER OF SEVERE ELECTRICAL SHOCK IF THE CUT OFF PLUG IS INSERTED INTO ANY 13 AMP SOCKET.

If a new plug is to be fitted please observe the wiring code as shown below.

If in any doubt please consult a qualified electrician.

WARNING : THIS APPLIANCE MUST BE EARTHED.

IMPORTANT : The wires in this mains lead are coloured in accordance with the following code:

<i>Green-and-Yellow :</i>	<i>Earth</i>
<i>Blue :</i>	<i>Neutral</i>
<i>Brown :</i>	<i>Live</i>

As the colours of the wire in the mains lead of this appliance may not correspond with the coloured markings identifying the terminals in your plug, proceed as follows.

The wire which is coloured GREEN-AND-YELLOW must be connected to the terminal in the plug which is marked with the letter E or by the Earth symbol  or coloured GREEN or GREEN-AND-YELLOW.

The wire which is coloured BLUE must be connected to the terminal in the plug which is marked with the letter N or coloured BLACK.

The wire which is coloured BROWN must be connected to the terminal in the plug which is marked with the letter L or coloured RED.

Precaution

How to replace the fuse : Open the-fuse compartment with a screwdriver and replace the fuse and fuse cover.

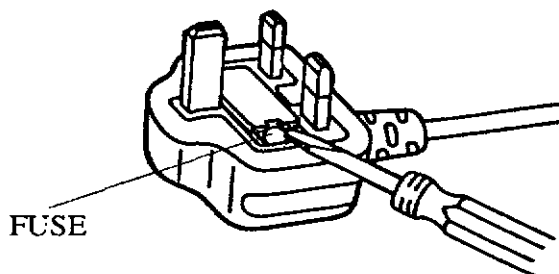

IMPORTANT INFORMATION

Do not connect KX-TVP100E to any AC outlet other than the standard AC 230–240V, 50Hz.

Ringer Equivalence Number (REN):

This relates to the performance of the apparatus when used in combination with other items of apparatus. It enables the calculation of the maximum number of items of apparatus that may be connected simultaneously to the line by summing the REN values of each items. A BT supplied instrument has a REN value of 1 unless otherwise marked. A maximum REN value of 4 should not be exceeded. The REN value of this apparatus is 3.

Connection:

- The apparatus is suitable for connection to a direct exchange line on the PSTN or via a compatible PBX.
- The apparatus is not suitable as an extension to a payphone and should not be used on lines with shared services.
- It cannot be guaranteed that the apparatus will operate under all possible conditions of connection to compatible PBX's.

This apparatus has been approved for the use of the following facilities:

- 1) Voice Mail Service
- 2) Auto-calling
- 3) Auto-answering
- 4) Auto-clearing
- 5) PBX timed break register recall
- 6) MF signalling
- 7) LD signalling

Any other usage will invalidate the approval of the apparatus if as a result, it then ceases to conform to the standards against which approval was granted.

Any cases of difficulty should be referred in the first instance to the supplier of the apparatus.

Attention

- Keep the unit away from heating appliances and electrical noise generating devices such as fluorescent lamps, motors and television. These noise sources can interfere with the performance of the Voice Processing System.
- This unit should be kept free of dust, moisture, high temperature (more than 40°C / 104°F) and vibration, and should not be exposed to direct sunlight.
- Never attempt to insert wires, pins, etc. into the vents or other holes of this unit.
- If there is any trouble, disconnect the unit from the telephone line. Plug the telephone directly into the telephone line. If the telephone operates properly, do not reconnect the unit to the line until the trouble has been repaired by an authorized Panasonic Factory Service Center. If the telephone does not operate properly, chances are that the trouble is in the telephone system, and not in the unit.
- Do not use benzine, thinner, or the like, or any abrasive powder to clean the cabinet. Wipe it with a soft cloth.
- Do not drop this unit to avoid the damage to the hard disk.

WARNING: TO PREVENT FIRE OR SHOCK HAZARD, DO NOT EXPOSE THIS PRODUCT TO RAIN OR ANY TYPE OF MOISTURE.

The serial number of this product may be found on the label affixed to the bottom of the unit. You should note the serial number of this unit in the space provided and retain this book as a permanent record of your purchase to aid in identification in the event of theft.

MODEL NO.: _____

SERIAL NO.: _____

For your future reference

DATE OF PURCHASE _____

NAME OF DEALER _____

DEALER'S ADDRESS _____

How To Use This Manual

This manual consists of 7 chapters as follows:

- **Chapter 1 Overview** — explains the outline of the Voice Processing System (VPS).
- **Chapter 2 System Installation** — explains the basic system installation and wiring instructions, as well as how to install the optional cards.
- **Chapter 3 Detailed Feature and Service Descriptions** — explains all features and services in alphabetical order. It also provides information about the programming required, conditions and related features.
- **Chapter 4 System Administrator's Guide** — explains terminal based programming through the System Administrator Interface.
- **Chapter 5 System Manager's Guide** — explains telephone based programming through the System Manager Mailbox.
- **Chapter 6 Message Manager's Guide** — explains message management, recording system prompts and company greetings through the Message Manager Mailbox.
- **Chapter 7 Maintenance** — explains Utility Commands, System Usage Reports, Initializing the System and Troubleshooting Guide.
- **Specifications**
- **Index**
- **Worksheets**

Terms to Know

There are terms used throughout this manual.

- **System Administrator** The person in charge of system setup tasks such as setting system parameters and running reports using a data terminal.
- **System Manager** The person in charge of daily management of system, such as creating and deleting mailboxes, changing system parameters, using touch-tone telephone.
- **Message Manager** The person in charge of recording prompts used on system-wide basis.
The Message Manager is also responsible for answering operator-seeking calls and handling messages left in the General Delivery Mailbox as an operator.
- **Subscriber** The owner of a personal mailbox. Subscribers can retrieve their messages (left by callers) from any touch-tone telephone.
Subscribers can also access various features of the VPS by accessing their own mailboxes.
- **Non-Subscriber** Outside callers who do not have their mailboxes. They can select a mailbox to leave a message by pressing DTMF keypad of their telephone. As to rotary callers, they can be automatically sent to the General Delivery Mailbox or the operator.
- **Mailbox** A storage place for messages on the VPS. A Subscriber (mailbox owner) can access many functions by dialing it. Also, mailboxes are usually associated with an extension that is often the same number.
- **Port** An interface between the telephone line and the VPS. The VPS can have a maximum of four ports, so it can handle four calls at a time.
- **Prompts** A recorded list of options or a guidance message played to the user.
System Promptset in English at the factory
User Promptto be recorded by the Message
(User 1 and User 2) Manager so that Multi-Lingual
Service can be available

Contents (KX-TVP100 Installation Manual)

Chapter 1 Overview

1.1	Introduction	1-2
1.2	Call Services	1-4
1.3	Other Features	1-7
1.4	Outline Caller Handling	1-9
1.5	Configuration	1-10
1.6	Guidelines for Preparation	1-11
1.7	Mailbox Management	1-15
1.8	System Diagnosis	1-17

Chapter 2 System Installation

2.1	System Components	2-2
2.1.1	Port Card	2-4
2.1.2	CPU Card	2-4
2.1.3	Hard Disk Drive	2-5
2.2	Installation	2-6
2.2.1	Preparation	2-6
2.2.2	System Expansion	2-7
2.2.3	Extension or CO Line Connection	2-11
2.2.4	Data Terminal or Printer Connection	2-15
2.2.5	Power Cable Connection	2-18

Chapter 3 Detailed Feature and Service Descriptions

A	Alternate Extension Group	3-3
	Auto Configuration (D-PITS Only)	3-3
	Auto Forwarding	3-3
	Automated Attendant Service	3-4
B	Broadcasting Messages	3-7
	Busy Coverage Mode	3-7
C	Callback Number Entry	3-7
	Call Blocking	3-9
	Call Screening	3-9
	Call Services	3-9

Contents

	Call Transfer Status	3-10
	Class of Service	3-12
	Company Greetings	3-12
	Covering Extension	3-13
	Custom Service	3-13
D	Day Service	3-19
	Daylight Saving Time Assignment	3-19
	Department Dialing	3-19
	Dialing by Name	3-20
	Direct Mailbox Access (D-PITS Only)	3-21
	D-PITS	3-21
E	Extension Group	3-22
	Extension Numbering Plan	3-22
	External Message Delivery List	3-22
	External Message Delivery Service	3-22
	External Message Delivery Status	3-24
F	Fax Management	3-24
G	Group Distribution List, Personal	3-25
	Group Distribution List, System	3-25
H	Hold	3-26
	Holiday Service	3-26
I	Inband	3-26
	Incomplete Call Handling Service	3-29
	Intercom Paging (D-PITS Only)	3-30
	Interview Service	3-31
L	Live Call Screening (D-PITS Only)	3-32
	Logical Extension (All Calls Transfer to Mailbox)	3-33
M	Mailbox	3-33
	Mailbox Group	3-35
	Message Delivery, Internal	3-36
	Message Delivery Status	3-36
	Message Reception Mode	3-37
	Message Scan	3-37
	Message Transfer	3-38
	Message Waiting Notification-Device	3-38

Contents

	Message Waiting Notification-Lamp	3-41
	Multi-Lingual Service	3-42
N	No-Answer Coverage Mode	3-46
O	Operator Service	3-46
P	PBX Integration	3-47
	Personal Greetings	3-48
	Play System Prompt After Personal Greeting	3-49
	Port Service	3-49
	Private Message	3-50
R	Receive Message	3-50
	Record Message	3-51
	Reply to Message Sender	3-51
	Rotary Telephone Service	3-52
S	Selection Menu	3-52
	Service Access Commands	3-53
	Special Feature Authorization	3-53
	System Clock	3-54
	System Reports	3-54
T	Two-Way Recording (D-PITS Only)	3-55
U	Utility Commands	3-56
V	Voice Mail Service	3-56
	Voice Prompts	3-58

Chapter 4 System Administrator's Guide

4.1	System Administrator's Function	4-2
4.2	Using the Interface	4-4
	4.2.1 Keyboard Operation	4-4
	4.2.2 Programming Guidance	4-5
4.3	Startup System	4-6
	4.3.1 Quick Setup	4-8
4.4	Programming Menu Structure Diagram	4-16
4.5	Programming the System Parameters	4-18
	4.5.1 Setting up Mailboxes	4-19

Contents

4.5.1.1	Creating and Editing Mailboxes	4-19
4.5.1.2	Deleting a Mailbox	4-25
4.5.1.3	Resetting a Mailbox Password	4-25
4.5.1.4	Listing Mailboxes	4-26
4.5.2	Setting COS (Class of Service) Parameters	4-27
4.5.2.1	Class of Service Setting	4-27
4.5.2.2	Special Feature Authorization	4-32
4.5.3	Port Service	4-37
4.5.3.1	Port Assignment	4-37
4.5.4	Service Settings	4-40
4.5.4.1	Automated Attendant Parameters	4-40
4.5.4.2	Custom Service	4-50
4.5.5	System Parameter Settings	4-53
4.5.5.1	System Group Assignment	4-53
4.5.5.2	Day Service	4-57
4.5.5.3	Holiday Setting	4-58
4.5.5.4	Daylight Saving Time	4-61
4.5.5.5	Prompt Setting	4-62
4.5.5.6	Other Parameters	4-63
4.5.6	Hardware Settings	4-76
4.5.6.1	RS-232C Parameters	4-76
4.5.6.2	Port Setting	4-77
4.5.6.3	PBX Interface Parameters	4-78

Chapter 5 System Manager's Guide

5.1	System Manager's Function	5-2
5.2	Accessing the System Manager's Mailbox	5-3
5.3	Setting up Mailboxes	5-4
5.3.1	Creating and Editing a Mailbox	5-4
5.3.2	Deleting a Mailbox	5-6
5.3.3	Deleting a Mailbox Password	5-6
5.4	Setting COS (Class of Service) Parameters	5-7
5.5	Setting the System Clock	5-11
5.6	Checking System Usage (System Reports)	5-12
5.6.1	Obtaining System Reports	5-12
5.6.2	Clearing the Reports	5-13

Contents

5.7	Delivering Messages	5-14
5.7.1	Delivering Messages to All Mailboxes (Broadcasting Messages).....	5-14
5.7.2	Delivering Messages to Specified Mailboxes.....	5-14
5.7.3	Checking Mailbox Distribution	5-15
5.8	Customizing the System Manager's Mailbox	5-16
5.9	Listening to Messages	5-17

Chapter 6 Message Manager's Guide

6.1	Message Manager's Function	6-2
6.2	Accessing the Message Manager's Mailbox	6-3
6.3	Managing the General Delivery Mailbox	6-5
6.3.1	Listening to Messages.....	6-5
6.3.2	Transferring Messages	6-6
6.4	Setting up Message Waiting Notification	6-7
6.4.1	Setting Message Waiting Lamp Status	6-7
6.4.2	Setting Notification by Calling Status	6-7
6.4.2.1	Setting Device Status	6-7
6.4.2.2	Assigning Notification Numbers	6-8
6.5	Customizing the Message Manager's Mailbox	6-10
6.5.1	Message Manager's Password	6-10
6.5.2	Operator's Extensions	6-10
6.6	Setting the System Clock	6-11
6.7	Recording Company Messages	6-12
6.7.1	Recording Company Greetings.....	6-12
6.7.2	Recording Company Name	6-12
6.7.3	Recording Department Dialing Menu Messages	6-13
6.7.4	Recording Custom Service Menu Messages.....	6-14
6.7.5	Recording Voice Labels for Mailbox Lists	6-15
6.7.6	Recording User Prompts	6-15
6.7.7	Recording Selection Menus	6-16
	List of Modifiable Prompts	6-18

Chapter 7 Maintenance

7.1	Utility Commands	7-2
------------	-------------------------------	------------

Contents

7.1.1	Off-line Set (OFLN)	7-2
7.1.2	On-line Set (ONLN)	7-3
7.1.3	Set Password (PASS)	7-3
7.1.4	Set Time (TIME)	7-4
7.1.5	Print Reports at Specified Time (PSET)	7-5
7.1.6	Error Log Display (ELOG)	7-5
7.1.7	Saving the System Data to the Backup Device (SAVE)	7-7
7.1.8	Loading the Saved Data to the VPS (LOAD)	7-9
7.1.9	Print All of the VPS Parameters (GPRN)	7-10
7.1.10	Program Version Display (VERS)	7-10
7.1.11	Custom Service Report (CREP)	7-11
7.1.12	Custom Service Menu Access Count Clear (CCLR)	7-11
7.1.13	Message Waiting Lamp Retry Times (MWL)	7-12
7.1.14	Setting Minimum Recording Length (MRL)	7-12
7.1.15	Modified Prompt List (MPLT)	7-13
7.1.16	Utility Command List (HELP)	7-14
7.1.17	Quick Setup (QSET)	7-14
7.2	System Reports	7-15
7.2.1	Mailbox Assignments	7-15
7.2.2	COS (Class of Service) Assignments	7-16
7.2.3	System Service Report	7-17
7.2.4	Call Account Report	7-18
7.2.5	Port Usage Report	7-18
7.2.6	Disk Usage Report	7-19
7.2.7	Mailbox Usage Report	7-20
7.2.8	Fax Call Report	7-22
7.3	Initializing the System	7-23
7.4	Troubleshooting Guide	7-25

Specifications

Index

Worksheets

Chapter 1

Overview

This chapter describes the outline of the Voice Processing System (VPS).

Contents

1.1 Introduction	1-2
1.2 Call Services	1-4
1.3 Other Features	1-7
1.4 Outline Caller Handling	1-9
1.5 Configuration	1-10
1.6 Guidelines for Preparation	1-11
1.7 Mailbox Management	1-15
1.8 System Diagnosis	1-17

1.1 Introduction

Welcome to the Panasonic Voice Processing System

The Voice Processing System (VPS) is a flexible, automated communication tool that may have a profound effect on the productivity of your work place.

The TVP100 is a 4-port system. It can store up to six hours of voice data. Each VPS port is connected to an extension port of a PBX. How the VPS and PBX communicate is quite simple. The PBX thinks that the VPS is a single line telephone. The VPS will mimic all the actions that a live attendant would carry out from an ordinary single line telephone. The voice prompts help you command the VPS. You can communicate with the VPS using keys on your phone.

The VPS enables you to receive and deliver messages using mailboxes which are assigned to each of you. You can control all your calls responding to voice prompts with the touch of a key entry on a phone, even if you are away from your office. The VPS follows your instructions quickly and gives you reliable, accurate services. Whether you are out of the office, on the phone, or just unavailable to answer the phone, the VPS handles all your calls accordingly. For example, transferring to an extension directly, paging over the intercom system, taking a message in a mailbox, and so forth.

If messages arrive in your mailbox, the VPS will notify you by using a lamp on the phone, a beeper or a telephone call. With this feature, you do not have to worry about missing important calls.

Exchanging information with the VPS is fast and simple. You can leave a voice message without speaking directly to the recipient by accessing the desired mailbox.

You do not need any extra paperwork. The editing function in the system enables you to review and change messages. Also you can assign a password to your message to protect it from being heard by any other person.

The VPS increases the value of time spent in your business and personal life by minimizing paperwork. It sends messages and notifies you of new messages at the exact time you designate. It never wastes time by tying you up with lengthy calls. For both you and outside callers, the VPS will contribute greatly to the growth of your telephone service.

1.1 Introduction

The VPS provides four incoming call services: Automated Attendant service, Voice Mail service, Custom service, or Interview service. A number of features incorporated into the VPS can be carried out depending upon your communication needs. By assigning one of the incoming call services to a VPS port, people who dial the VPS telephone number can select specific communication features by responding to the voice prompts. You can use the VPS as a backup receptionist to handle the overflow of unanswered calls to your live attendant. Or you can use the system to guide your callers to the services you provide. The VPS is equipped with many convenient features which will allow you to create an effective communication system to suit your needs.

1.2 Call Services

You can set the VPS to answer incoming calls with the following four call services: Automated Attendant service, Voice Mail service, Custom service, or Interview service. These services can be assigned to each VPS port. See **Port Assignment** in Chapter 4.

Each service can not only be assigned to a VPS extension as an independent service, but also can be used in combination with other services. Refer to these four services in Chapter 3.

Callers can also access the Automated Attendant service and Voice Mail service any time by pressing the appropriate Service Access Command key during the other call services (see **Service Access Command** in Chapter 3).

Automated Attendant Service

When callers reach this service, they will hear a list of options. Callers can reach their desired party by entering the extension number followed by [#]. Callers may also dial by department (**Department Dialing**) or by name (**Dialing by Name**). The VPS responds to the command by either routing the caller to the extension or the operator. When a station is specified, the call will be treated with the Call Transfer status set up by each station:

— **Call Blocking**

You can block incoming calls so as not to be connected with your extension.

— **Call Screening**

The VPS tells you the caller's name before connecting the call. You can decide whether or not to answer the call.

— **Intercom Paging**

The VPS pages you over the intercom paging system.

— **Calling a Beeper**

The VPS calls your beeper and displays the caller's callback number on the beeper display.

For further information, refer to **Call Transfer Status** in Chapter 3. You also have the option of not setting a Call Transfer Status. Call will be directly connected with your extension. Even if the extension is busy or there is no answer, the VPS will handle the call with one of the following:

— **Hold**

When the extension is busy, the caller has the option of holding the call temporarily. After a short period, the VPS will call the extension again.

— **Leaving a Message**

The caller is automatically transferred to the mailbox of the extension.

1.2 Call Services

— Transfer to the Covering Extension

The call is transferred to the covering extension which handles the call by its own Call Transfer status.

— Intercom Paging

The VPS pages you over the intercom paging system.

— Calling a Beeper

The VPS calls your beeper and displays the caller's callback number on the beeper display.

— Calling the Operator

The caller can talk to the operator.

— Returning to the Automated Attendant Top Menu

The call is sent back to the top menu of the Automated Attendant service and may have the option of calling another extension.

You can activate several options simultaneously so that the caller can choose one among them. See **Incomplete Call Handling Service** in Chapter 3 which describes this in detail.

Voice Mail Service

This service is a voice message receiving and delivery service which allows callers to leave messages. After accessing this service, callers reach the desired mailbox by entering the mailbox number followed by [#]. Meanwhile, you can use other versatile features (Subscriber service):

— Message Scan

You can listen to the first four seconds of each recorded message.

— Receive Message

You can playback messages.

— Message Transfer

After listening to the messages, you can transfer them to other mailboxes with your additional comments.

— Message Delivery, Internal

The VPS will automatically deliver your message to other mailboxes.

— Private Message

You can prohibit your message from being transferred to other mailboxes.

— Group Distribution List, System/Personal

You can send the identical message to several mailboxes with a single operation.

— Extension Group

You can share one mailbox with other people in your company.

1.2 Call Services

— Message Delivery Status

You can check if your message has been already sent to the desired destination.

See Chapter 3 for other available features. And for Subscribers, the *Subscriber's Guide* has been edited to show how to use these features from a telephone.

Your VPS messages are safely locked in a mailbox guarded by a password known only to you. The VPS also reduces "telephone tag" and illegibly-written messages as well as giving you a confidential form of communication. Likewise, this service can be used to encourage development of concise messages, making it an efficient time-management tool. For example, you can minimize interruptions when you need to focus on work at hand by forwarding your calls to the VPS. The Voice Mail service can also be a reminder service, by scheduling messages to yourself.

Interview Service

When most of your callers will want a service like service scheduling and order taking, using the interview mailbox. It will help you gather concise information in a methodical way. You can set up a questionnaire mailbox with as many as ten questions, and obtain specific information from customers calling the VPS. When callers access this mailbox, they can leave messages responding to a series of questions presented to them. An interview mailbox can be assigned to each mailbox owner depending upon the Class of Service setting. Therefore, the questions can be recorded by the owner of the interview mailbox by telephone. One of the interview mailboxes can be used for the Interview service on a port basis.

Custom Service

By assigning specific functions to the telephone keypad digits, callers can access the services or people they need. This service is the key to making your business stronger. For example, the VPS can give your customers 24-hour service: they can leave orders in mailboxes, obtain product information, or notify your service staff of an emergency. Callers can reach their desired extensions or mailboxes by selecting a key one by one. On the other hand, callers can skip the Custom service menus to go to either the desired party or mailbox.

The System Administrator is responsible for programming each custom service menu. The custom service menu messages are recorded by the Message Manager.

In regarding the Custom service and Interview service, it is necessary to program the details on your own. You will find a programming example in Chapter 3. See **Custom Service and Interview Service**.

1.3 Other Features

Some of the mailbox features are restricted in some mailboxes. The following features are only available to mailbox owners who are authorized by the Class of Service (COS) setting.

Message Waiting Notification

The VPS will notify you of messages which came in your mailbox by illuminating the message waiting lamp on your extension and by calling a pre-programmed telephone or beeper. The telephone number of the caller can be displayed on the beeper instead of a VPS extension number. In this case, you can directly contact with the caller in an emergency without retrieving the message in the mailbox. When you often work out of the office, this service eliminates the need to regularly check your mailbox. Also up to two time frames can be set on each day of the week. You can not only concentrate on your work but also deal with an urgent matter wherever you are.

External Message Delivery

In addition to message delivery to other mailboxes, the VPS can send your message to people outside of your company. You can also set the delivery date and time. When the set time comes, the VPS will call the destination. The VPS voice prompts will tell the receiver to receive the message. Only the person who knows the password can listen to the message. With the password (four digits), the VPS gives you a reliable, confidential communication service.

Auto Forwarding

You can set the unreceived messages to be forwarded or copied automatically to another mailbox. With this feature, you can assign your job to another extension on your day-off.

When the VPS is connected to a Panasonic KX-TD series telephone system with D-PITS Voice Mail Integration, the following convenient features will enhance the mailbox operation.

Live Call Screening (LCS)*

LCS is like having an answering machine right at your desk. It combines the functions of the VPS with a proprietary telephone set. When the LCS feature is activated, you can monitor incoming messages to the mailbox, and decide whether or not to take the call.

1.3 Other Features

Two-Way Recording*

This feature reduces the trouble of writing down messages. You can record a conversation in the mailbox or another person's mailbox while talking on the phone. If you press the feature key on your proprietary telephone, the VPS will start to record your telephone conversation.

Direct Mailbox Access*

You can reach your mailbox by simply dialing a VPS extension without dialing your mailbox number. All you have to do is to enter the correct password.

* Applicable only when you have a Panasonic KX-TD series telephone system and the D-PITS Voice Mail Integration is activated.

Chapter 3 describes these features in detail.

1.4 Outside Caller Handling

The VPS helps the callers access his desired party. The VPS plays voice prompts to instruct him what to do next. The caller has only to press the suitable key on the phone following the voice prompts.

Even rotary telephone callers can make use of the VPS. The system can be set to send callers to the operator or the General Delivery Mailbox (G.D.M.). When they leave messages in the G.D.M., the Message Manager will transfer the message to other mailboxes. See **Rotary Telephone Service** in Chapter 3.

With the VPS, you can also communicate with people all over the world. To expand your business field, the VPS has been designed to support up to three languages. Callers can choose the language of the instructions of the VPS. The first language, English, is recorded at the factory. The second and the third languages are recorded by the Message Manager according to your business needs. See **Multi-Lingual Service** and **Voice Prompts** in Chapter 3.

When the callers accesses the VPS, he is greeted by one of 32 company greetings. The Message Manager records the greetings so that they greet the callers properly also on holidays or in after-hours. See **Company Greetings** in Chapter 3.

The VPS connects the caller who needs a human help with the operators. He can reach a live operator by pressing [0] at any time. Up to three operators can be assigned in case the first operator answer the call. See **Operator Service** in Chapter 3.

Callers can access the desired extension by dialing a one-digit number (1–9) when they are in the Department Dialing menu. For callers to access the Department Dialing service, the Service Access Command [#] [3] is available. See **Department Dialing** in Chapter 3.

Some callers who do not know the number of their desired extensions or mailboxes may be unable to enter the correct number when asked by the VPS. However, they can also reach the desired party by dialing the first three or four letters of the persons' last name. For callers to access this feature, the Service Access Command [#] [1] is available. See **Dialing by Name** in Chapter 3.

Because written communication is also essential to enhance the efficiency of your business capability, you may want to have fax calls received frequently. To avoid being interrupted by fax signals, the VPS identifies a fax call and transfers it to a fax extension for you. Up to two fax extensions can be specified as the destination, so that one serves as a backup for the other. The system notifies a specified person whether the fax call was successfully completed. See **Fax Management** in Chapter 3.

1.5 Configuration

VPS Connections to the PBX

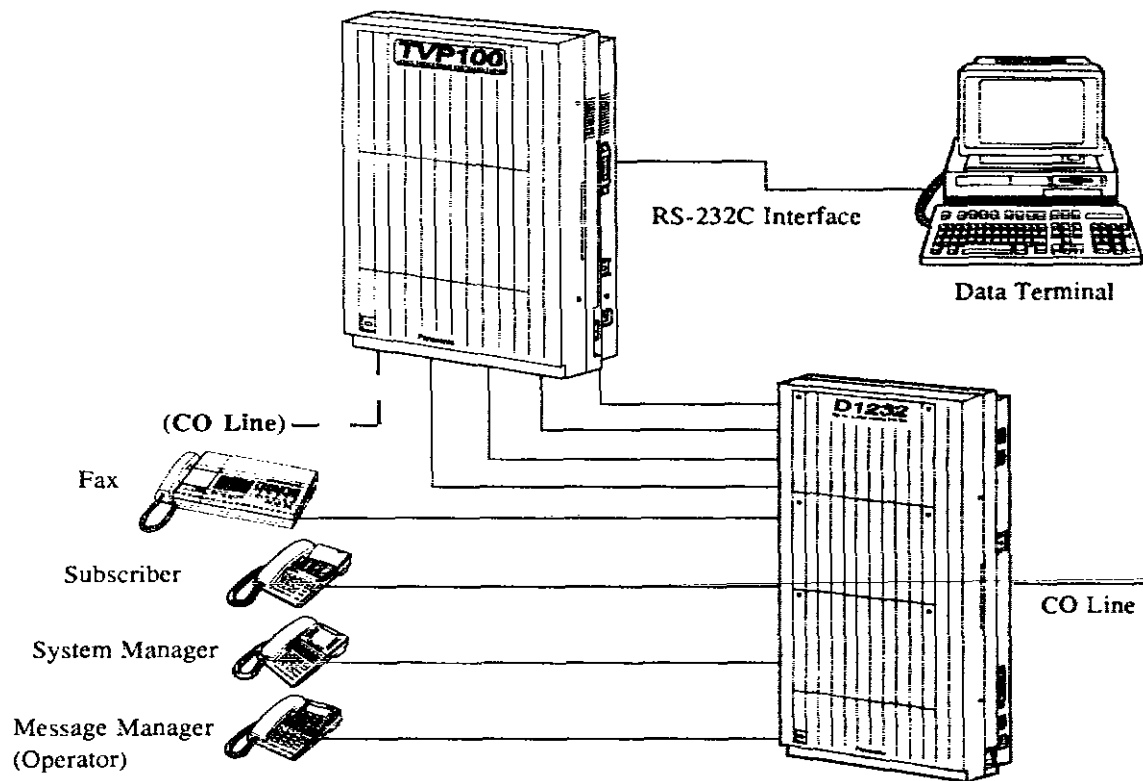

1.6 Guidelines for Preparation

Programming

System Administrator

The System Administrator is responsible for setting up system parameters, administering the parameters, or diagnosing the system with the use of an interactive screen based program. The VPS can be programmed using VT100, Compatible Terminals or other ASCII Terminals. On top of each screen display in this manual, you will find a programming instruction indicated by an arrow (see page 4-5). This will help you locate the desired programming screen quickly.

To begin with, confirm that the system installation preparations are complete and that the rotary switch is set to the right value (see Chapter 2).

After you finish system startup, we recommend that you employ the Quick Setup feature. This provides a quick way of setting up the VPS for basic Voice Mail or Automated Attendant service. It includes mailbox creation, incoming call service setting for all ports, time setting, password setting and several other programming items which must be done initially in order to start the VPS operation. See **Quick Setup** in Chapter 4.

The VPS provides a remarkable setup which is a combination of the startup system and the Quick Setup. In other words, the Quick Setup can be done automatically when you start up the VPS when D-PITS Voice Mail Integration with a Panasonic KX-TD series telephone system is activated (see page 4-3). The VPS obtains necessary information from your PBX over data link: extension numbers which the VPS refers to create mailbox and the time. See **Auto Configuration** in Chapter 3.

If you select the *Program* mode at the System Administration top menu (see page 4-7), you can customize the VPS:

— **Mailbox Setting**

You can edit the parameters of each mailbox. Also, you can set parameters for the Message Waiting Notification-Device feature, including the time frame setting.

— **Class of Service**

You can define a set of services (1-64) available for each mailbox.

— **Port Service**

You can assign one of four incoming call services to each VPS port. According to the set port service, you need to select a proper company greeting.

— **Service Setting**

You can set up some features which are related to the Automated Attendant service: Department Dialing, Operator Service, Alternate Extension.

1.6 Guidelines for Preparation

Furthermore, you can program the Custom service by assigning a specific functions or services to each key.

— System Parameter Setting

- **System Group Assignment**
You can set up mailbox groups and extension groups. Up to 20 group lists can be programmed respectively.
- **Holiday Setting**
You can specify the incoming call service parameters which will be used on holidays.
- **Daylight Saving Time**
You can set the VPS to adjust the clock for daylight savings time.
- **Prompt Setting**
You can program the Multi-Lingual service.
- **Other Parameters**
You can specify the parameters used for outgoing call services: Message Waiting Notification, External Message Delivery.
You can allow callers to hold when the line is busy.
You can define how to handle rotary telephone callers.
You can program the intercom paging parameters in accordance with your PBX.
You can enable the VPS to transfer fax calls to the fax machine automatically.

— Hardware Setting

You can modify RS-232C parameters.

You can also specify the dialing parameters such as an integration mode to your PBX.

Chapter 4 describes in detail how to set these parameters.

Telephone Programming

The System Manager and the Message Manager can also log in the VPS by telephone to change the system parameters and to record the voice prompts.

To log in by telephone, call the VPS and gain access to the Voice Mail service. Then enter the star key and one of their mailbox numbers. You can set the password (up to eight digits) to prevent other people from logging into these two mailboxes.

1.6 Guidelines for Preparation

System Manager

You can change the system parameters through the System Manager's mailbox.

In the System Manager's main command menu, you can coordinate the VPS, even though some of the programming items overlap those by the System Administrator:

— **Setting up Mailboxes**

You can assign a mailbox to people in your company. Up to 62 mailboxes can be created excluding the System Manager's mailbox and the Message Manager's mailbox.

On the other hand, you can delete a mailbox. Or you can delete a mailbox password so that the mailbox owner can reset the password.

— **Setting Class of Service (COS) Parameters**

You can define each set of services (1-64) available for the mailbox owners. Class of Service determines the mailbox capacity, whether or not to enable the special features and so forth. It is also possible to assign a sub-mailbox called an Interview mailbox. The mailbox owner who has this mailbox can record questionnaires to the callers.

— **Setting the System Clock**

You can set the time after a prolonged power loss.

— **Checking System Usage**

You can obtain eight types of system reports to monitor the VPS operating status.

There is a feature called **Broadcasting Messages** which is unique to the System Manager. You can deliver a message to all the mailbox owners at the same time. For example, you can report the schedule of a company event. You do not have to type a letter or make copies and deliver them to all the people in your company. By using Broadcasting Messages, your message is distributed through the VPS.

When you program, refer to Chapter 5.

Message Manager

Via the Message Manager's mailbox, you can record voice prompts which are played to callers, such as company greetings, department dialing menu messages and so on.

In the Message Manager's main command menu, you can manage following items:

— **Recording Company Greetings**

You can record up to 32 company greetings which played to callers when they reach the VPS.

1.6 Guidelines for Preparation

— **Recording Company Name**

When the person who receives an external message fails to enter the password which is assigned to that message, he receives the recorded company name.

— **Recording Department Dialing Menu Messages**

You can record the voice prompts that will guide callers to a speed dialing feature.

— **Recording Custom Service Menu Messages**

You can record the voice prompts that will guide callers to their desired service by going down the layers of menus.

— **Recording Voice Labels for Mailbox Lists**

You can record a name for each mailbox list.

— **Recording User Prompts**

You can record the voice prompts in other languages to support the Multi-Lingual service.

— **Recording Selection Menus**

You can record the language selection menu message that prompts callers to select the desired language.

When you program, refer to Chapter 6.

1.7 Mailbox Management

When you have a mailbox, you are regarded as a Subscriber. You can receive and send messages and answer incoming calls via a mailbox. Before you begin normal operations, you have to log into the main command menu to customize your mailbox. You can set up your mailbox by telephone. Just call the VPS Voice Mail service and enter the star key and your mailbox number. It is important to also have a password (up to eight digits) to access the Subscriber service menu.

You have to set up your mailbox about the following before use:

— **Recording your name**

Played to the callers when they enter the spelling of your name to reach you.

— **Recording Personal Greetings**

Greet the callers who reach your mailbox. You can record three types.

— **Setting up a Covering Extension**

This extension may answer the call which you could not answer.

— **Recording Questions for the Interview Mailbox**

When you have an Interview mailbox by COS setting, callers can leave messages by responding to your questions.

— **Setting the Message Reception Mode**

Specifies whether to receive messages in the usual mailbox or the Interview mailbox.

— **Setting the Incomplete Call Handling Status**

Specifies how to treat calls when you are unable to answer. Six options are available: leaving a message, covering extension transfer, intercom paging, calling a beeper, operator transfer, or returning to top menu Automated Attendant service. See **Incomplete Call Handling Service** in Chapter 3.

— **Setting the Call Transfer Status**

Specifies how the VPS should handle incoming calls before connecting them to your extension. Five options are available; call blocking, call screening, intercom paging, calling a beeper, or transferring directly to your extension. See **Call Transfer Status** in Chapter 3.

You can also set the following additional features to use your mailbox more efficiently:

— **Entry of Personal Group Distribution Lists**

If you have put mailboxes together into a list, you can send the same message to these mailboxes by simply specifying the mailbox group number (1-4). You can create up to two lists with 20 entries per each list.

1.7 Mailbox Management

— **Message Waiting Lamp Notification Setting**

Specifies whether the VPS should notify you of recorded messages by illuminating the message waiting lamp of your telephone. Authorization by the COS is required.

— **Setting Notification by Calling**

Specifies whether the VPS should notify you of recorded messages by calling a pre-assigned telephone or a beeper. Authorization by the COS is required.

The *Subscriber's Guide* will explain the above in detail.

1.8 System Diagnosis

Using a data terminal connected to a RS-232C port of the VPS, you can maintain the VPS: running reports, backing up data, getting error logs. Besides the task of programming the system (see Chapter 4), the System Administrator is responsible for diagnosing the system (see Chapter 7).

System Reports

If you select the *System Reports* mode at the System Administration top menu (see page 4-7), you can get detailed information about VPS activities.

The System Reports provide statistics on system-wide operation and usage of the VPS. Therefore you can monitor various operational aspects of the VPS. These reports can be printed or displayed on a terminal.

- Mailbox Assignments
- Class of Service Assignments
- System Service Report
- Call Account Report
- Port Usage Report
- Disk Usage Report
- Mailbox Usage Report
- Fax Call Report

For more information, see **System Reports** in Chapter 7. Also, running system reports can be done by telephone via the System Manager's mailbox (See Chapter 5).

Utility Command

If you select the *Utility Command* mode at the System Administration top menu, the following Utility Commands can be used:

— **OFLN**

You can turn off the call progressing mode of the VPS, used for deleting a mailbox.

— **ONLYN**

You can restore the call progressing mode of the VPS.

— **PASS**

You can create and change system passwords.

— **TIME**

You can set the system date and time.

— **PSET**

You can set some of the system reports at designated time everyday.

1.8 System Diagnosis

— **ELOG**

You can get the error log of devices such as CPU card, Port card and hard disk drive.

— **SAVE**

You can back up voice prompts and all system programming data to a floppy disk on a data terminal.

— **LOAD**

You can restore the saved data to the VPS in the event of a hard disk drive failure.

— **GPRN**

You can display System Programming parameters.

— **VERS**

You can display the version of hard disk, main ROM and Port card.

— **CREP**

You can display the programming of Custom service.

— **CCLR**

You can clear the access count of each Custom service.

— **MWL**

You can specify the message waiting lamp retry times.

— **MRL**

You can set the minimum recording length of one message.

— **MPLT**

You can display the User Prompts recording status.

— **HELP**

You can display the available Utility Commands.

— **QSET**

You can start the Quick Setup.

Chapter 2

System Installation

This chapter tells you about the installation of the VPS and the expansion of the system.

Contents

2.1 System Components	2-2
2.1.1 Port Card	2-4
2.1.2 CPU Card	2-4
2.1.3 Hard Disk Drive	2-5
2.2 Installation	2-6
2.2.1 Preparation	2-6
2.2.2 System Expansion	2-7
2.2.3 Extension or CO Line Connection	2-11
2.2.4 Data Terminal or Printer Connection	2-15
2.2.5 Power Cable Connection	2-18

2.1 System Components

The Voice Processing System (VPS) comprises a main card (Port card and CPU card), a hard disk drive and proprietary system software.

Main Cabinet

TVP100 can be expanded to handle a maximum of four simultaneous calls by installing optional Port card and store up to six hours of voice data.

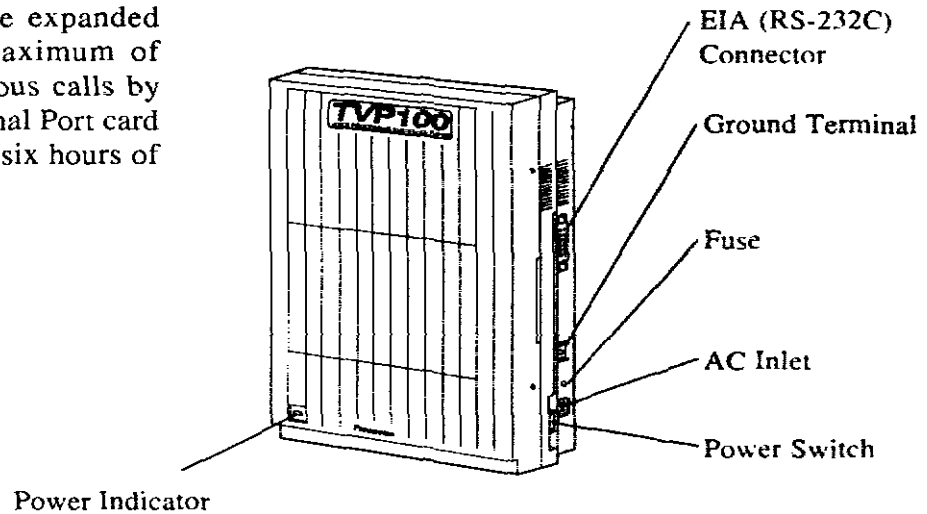

Note: EIA port is at SELV.

Inside View of the Main Cabinet

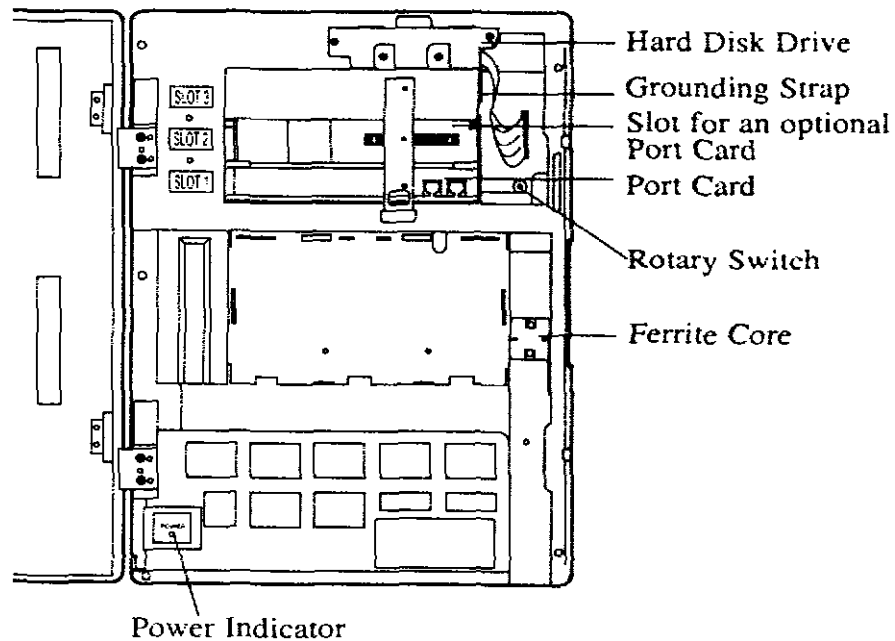

2.1 System Components

Main Cabinet Components

TVP 100	
Ground Terminal	Connect the frame of the main unit to ground.
EIA Connector (RS-232C)	Connecting a data terminal to the VPS unit via EIA connector allows the System Administrator to set the system parameters of the VPS. A serial printer can be connected to this port to print the reports.
Fuse	If the Power Indicator goes off while the system is running, the fuse may have been blown. When replacing the fuse with the new one, be sure the TVP100's Power Switch is turned off.
AC Power Jack	Connect the Power Cable to an AC outlet dedicated to the VPS unit.
Rotary Switch	The rotary switch is used, for example, when performing initial parameters settings.
Power Indicator	When turning on the Power Switch, this indicator flashes while setting up the system, then it lights to show the system is on-line mode.
Power Switch	Pressing the Power Switch starts the system beginning with the self test. When making any connections or opening the cover, be sure the Power Switch is turned off.
Grounding Strap	To protect the printed circuit board from static electricity, first discharge any body static by touching the grounding strap.

2.1 System Components

2.1.1 Port Card

The Port card includes the telephone line interface and the CODEC facility.

The telephone line interface transmits and receives analog and digital signals* to and from the telephone line. The analog input signal is digitized at a sampling rate of 8kHz to create an 8-bit digital signal.

The CODEC facility consists of two digital signal processors (DSP). When a user calls the VPS, one of the DSPs compresses the digital signal sent from the telephone line interface. This compressed signal is stored on the hard disk as data. When messages stored on the hard disk are played back, the DSP decompresses the stored data and the resulting signal is then sent to the telephone line interface where it is converted back to an analog signal.

* When used with KX-TD D-PITS Extension

2.1.2 CPU Card

The CPU card includes the central microprocessor, ROM, dynamic RAM, system controller, a Rotary switch and a RS-232C interface. It is mounted inside the main cabinet.

The central microprocessor communicates with and controls the DSPs on the Port card via FIFO memory.

The system ROM stores ROM-based system programs, self-diagnostic software, test programs and application program loader.

Application programs and the system administration table from the hard disk are read into dynamic RAMs for use by the system.

The rotary switch has several functions:

- Position 0: Factory preset
Normal setting

- Position 1: RS-232C parameters are initialized when the system is booted up. This setting should be used if there is some uncertainty about the parameters to be used when making connections.

2.1 System Components

Default RS-232C parameters are:

Speed : 9600 bps
Number of data bits : 8
Number of stop bits : 1
Parity : None

- Position 2*: When first installing the system, Quick Setup is automatically complete and all ports are set up to handle callers with Automated Attendant service (Please wait a minimum of two minutes for the setup to finish).
- Position 3*: When first installing the system, Quick Setup is automatically complete and all ports are set up to handle callers with Voice Mail service (Please wait a minimum of two minutes for the setup to finish).
- Position 5: System parameters are initialized and set automatically to the factory default values (see Chapter 4) when the system is booted up.

* When you have a Panasonic KX-TD series telephone system with D-PITS Voice Mail Integration

Notes: You must return the Rotary switch to position 0 after using positions 1, 2, 3, or 5. Otherwise, system programming, user recorded prompts, etc. may be lost on the next power up.

The RS-232C interface can be used to connect a terminal for system programming or a printer for printing reports.

2.1.3 Hard Disk Drive

The hard disk stores the proprietary system program, the system administration table, the voice prompts (about 40 minutes' worth) and has the capacity to record approximately six hours of messages from callers. The hard disk drive is controlled by the central microprocessor.

2.2 Installation

2.2.1 Preparation

— **Tools needed**

- Screwdriver
- Drill

— **Hardware**

- Install the VPS on the wall (See page 2-9)
- Connect telephone lines between the VPS and PBX (See page 2-12)
- Connect a data terminal or a printer to the VPS (See page 2-15)
- Connect the power cable to the VPS (See page 2-18)

— **Software**

- Set the RS-232C parameters (See page 4-76)
- Startup System (See page 4-6)
- Quick Setup (See page 4-8)

2.2 Installation

2.2.2 System Expansion

Installing an optional Port Card

The basic TVP100 VPS configuration utilizes two phone lines and is capable of handling two calls at a time. This basic configuration can be expanded to handle up to a maximum of four simultaneous calls. To increase capacity, install optional 2 Ports Expansion Card for VPS (KX-TVP102).

Precaution

When installing an optional Port card, make sure the Power Switch is turned off. To protect the printed circuit board from static electricity, first discharge any body static by touching the grounding strap. Refer to the manual accompanying the optional card about precautions and the installation procedure.

The optional Port card for system expansion should be inserted into a proper slot as illustrated below.

1. Remove adhesive tape from the card.



2. Loosen screw with a screwdriver.

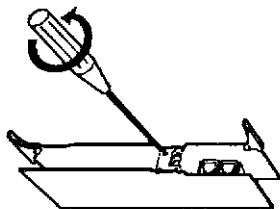

3. Loosen the screw on the grounding strap, then remove the strap from the unit.

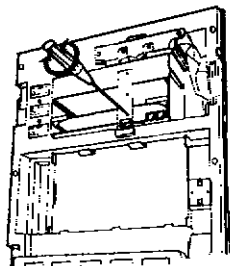

4. Insert the optional Port card into the SLOT 2 along with the guide rails.

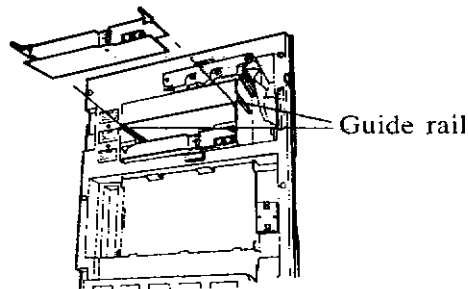

5. Press the left and right card latches firmly, then fix the grounding strap to the unit with a screwdriver.

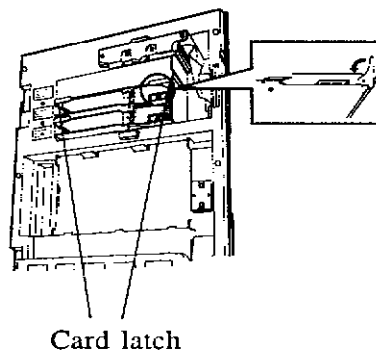

2.2 Installation

The VPS can be installed on the wall. Please read the following notes concerning installations and connections before installing the VPS.

Installation Precautions

Avoid installing the VPS in the following places:
(Doing so may result in malfunction, noise or discoloration.)

- 1 In direct sunlight and hot, cold, or humid places.
- 2 Areas where there are thermal springs, etc. where sulfuric gases may damage the equipment or contacts.
- 3 Places in which shocks or vibrations are frequent or strong.
- 4 Dusty places, or places where water or oil may come into contact with the unit.
- 5 Near high-frequency generating devices such as sewing machines or electric welders.
- 6 On or near computers, telexes, or other office equipment, as well as microwave ovens or air conditioners.
(It is preferable not to be installed in the same room with the above equipment.)
- 7 Install at least 1.8 m (6 feet) from televisions.
- 8 Do not obstruct the area around the PBX and the VPS. (Be especially careful to allow space for cooling above and at the sides of both systems for maintenance and inspection.)

Wiring Precautions

Make sure to observe the following instructions when wiring:

- 1 Do not wire the telephone cable parallel to an AC power source, computer, telex, etc. If the cables are run near those wires, shield the cables with metal tubing or use shielded cables and ground the shields.
- 2 If cables are run on the floor, use protectors or the like to protect the wires from being stepped on. Avoid wiring under carpets.
- 3 Avoid sharing the same AC power supply for computers, telexes, and other office equipment. Otherwise, the VPS operation may be interrupted by the induction noise from such equipment.

2.2 Installation

Mounting the VPS on the Wall

The wall where the VPS is to be mounted must be able to support the weight of the VPS. If screws other than the ones supplied are used, use the same-sized diameter screws as the enclosed ones.

To Mount on a Wooden Wall:

- 1 Place the template on the wall to mark the 3 screw positions.
- 2 Install the 3 screws into the wall.

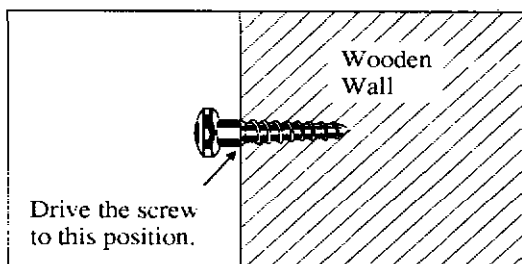
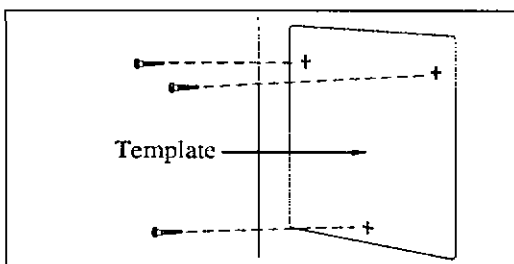

- 3 Hook the unit on the screw heads.

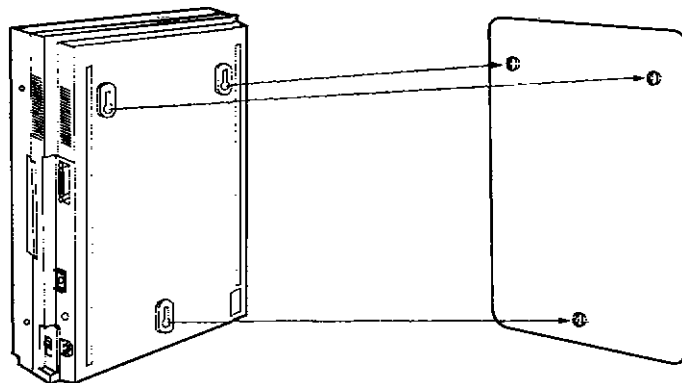

Note: The template is included with the unit.

2.2 Installation

To Mount on Concrete or Mortar Walls:

- 1 Place the template (included) on the wall to mark the 3 screw positions.
- 2 Drill 3 holes and drive the anchor plugs (included) with a hammer, flush to the wall.

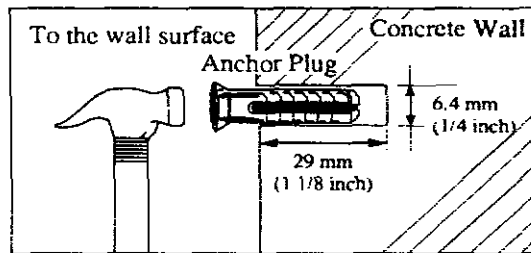

- 3 Install the 3 screws into the anchor plug.

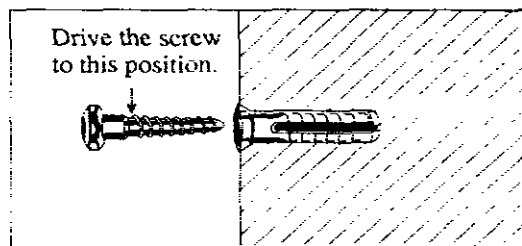

- 4 Hook the unit on the screw heads.

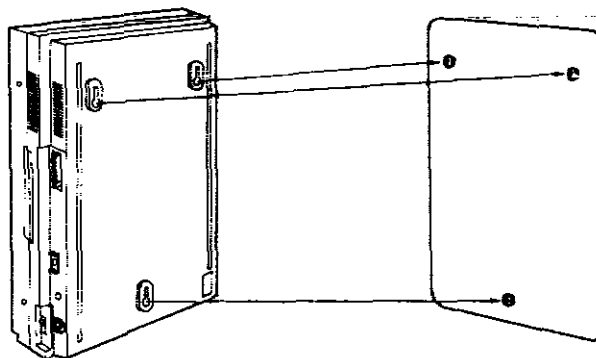

2.2 Installation

2.2.3 Extension or CO Line Connection

The VPS must be connected to extension or CO line before using the system. Up to four lines can be connected to the modular jacks on the Port card: one line per jack.

Warning: No other apparatus should be connected in parallel with this apparatus on the same line. Such connection may cause unsatisfactory operation and would invalidate the approval.

To connect telephone lines:

- 1 Loosen two screws on the right side of the main unit, then open the front cover in the direction of arrow (A).

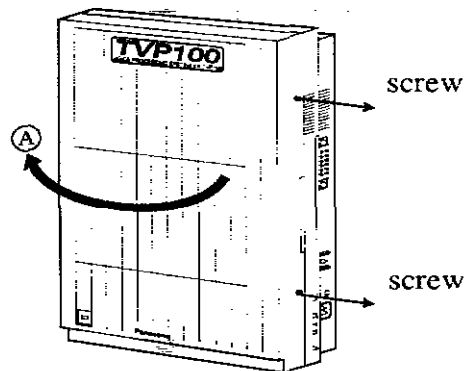

Note: The screws are attached to the front cover with springs so that they will not be lost.

- 2 Insert the screwdriver to the opening of the ferrite core and open it.

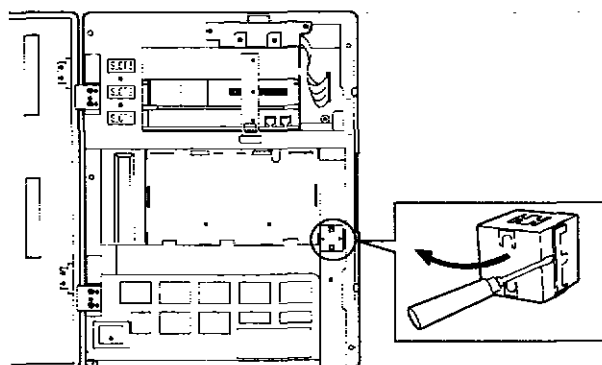

2.2 Installation

- 3 Insert the modular plug of the telephone cord into the modular jack on the Port card. Let the telephone cord through the ferrite core. Then close the ferrite core. If you install an optional Port Card (KX-TVP102), let the telephone cord through the ferrite core also.

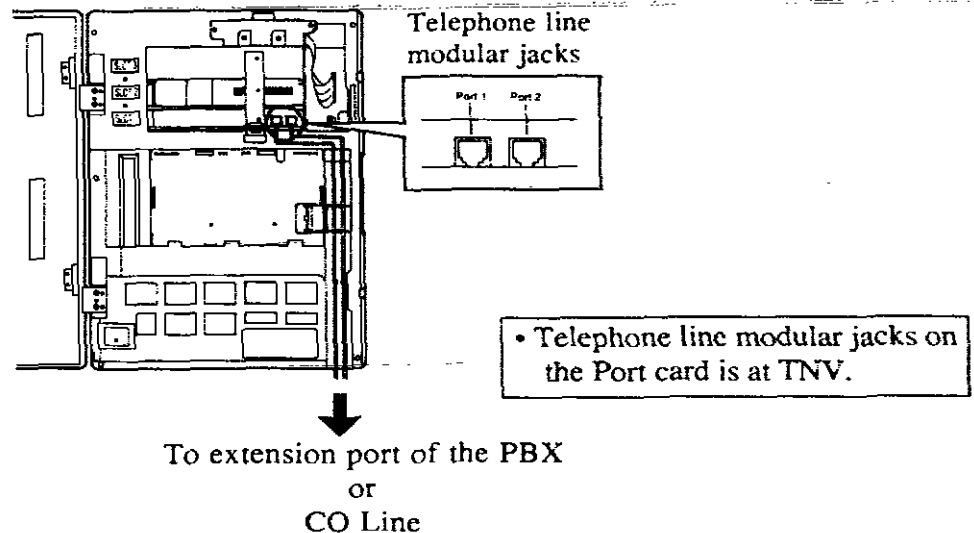

- Notes:**
- Make sure the telephone cord is connected to the proper modular jack. Modular jacks on the Port card correspond to the port numbers as follows:

Port Card	Modular Jack	Port Number
1	Left	1
1	Right	2
2	Left	3
2	Right	4

You can assign one of the incoming call services according to the port number.

- **When your PBX is a Panasonic KX-TD series telephone system:**

To utilize D-PITS Voice Mail Integration, Port 1 of the VPS must be connected to the lowest number jack assigned as a VPS extension. When D-PITS Voice Mail Integration is activated, a single extension jack on the PBX provides two single line interfaces with a Port card on the VPS.

2.2 Installation

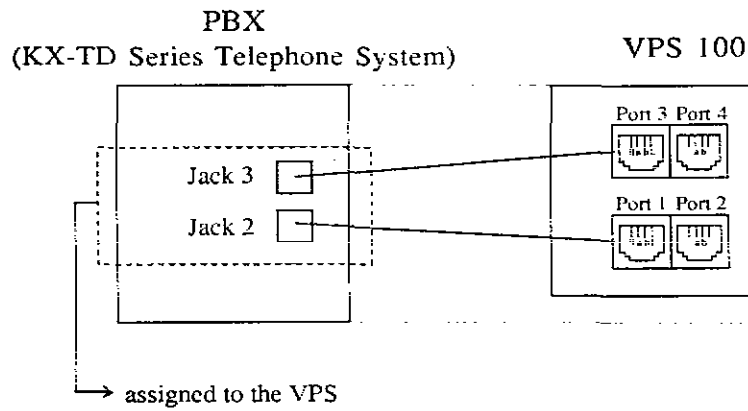

Example:

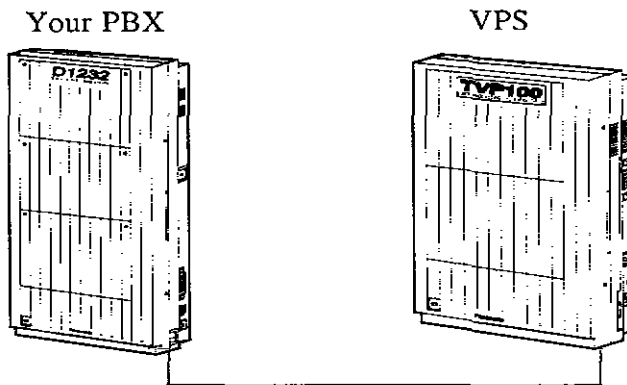

4 Connect the telephone cord.

- **Connecting to a Panasonic KX-TD series telephone system:**

Please refer to the below illustration.

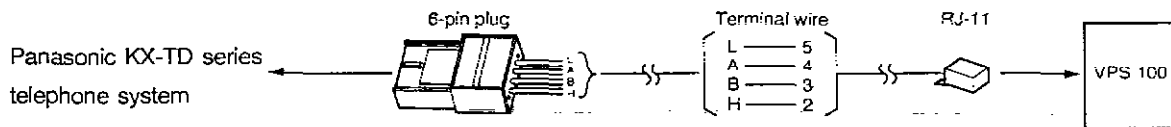

Note: If you make use of D-PITS Voice Mail Integration (see page 4-81), use a 4-conductor wiring cord.

2.2 Installation

- **Connecting to other PBX:**

Please refer to the below illustration.

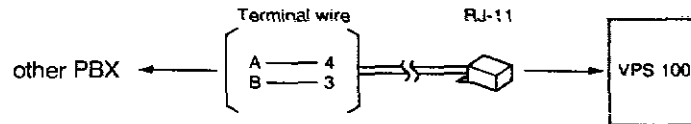

Note: Use a 2-conductor wiring cord. The maximum length of the wire varies according to your PBX type. Please refer to your PBX Installation Manual.

- **Connecting to CO Line:**

Please refer to the below illustration.

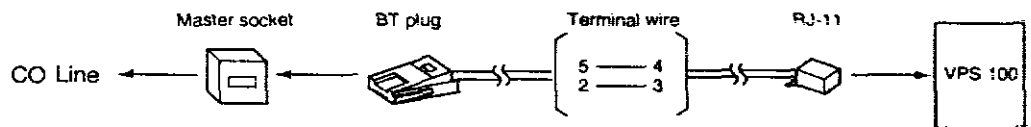

Note: Use a 2-conductor wiring cord.

The following models are recommended to be connected to the VPS:

- Panasonic KX-T30810BE-2
- Panasonic KX-T61610BE
- Panasonic KX-T123210BE
- Panasonic KX-TD816E
- Panasonic KX-TD1232E

- 5 Close the front cover of the VPS (and PBX if the cover is removed). Reverse the procedure of step 1.
- 6 Tighten the two screws firmly. Reverse the procedure of step 1.

2.2 Installation

2.2.4 Data Terminal or Printer Connection

For the system administration (system setup, mailbox setup, and system diagnosis), the RS-232C terminal must be connected to a serial interface (EIA port) of the unit. If the VT100 or VT100 compatible terminal is used, the System Administrator can set up system parameters and diagnose the system with the conversational menu-driven program. Other RS-232C terminals can be also used.

If you wish to output reports and the like to a printer, it must first be connected to the system using a RS-232C cable. The wiring and parameters are the same as those for a terminal. The communication parameters of the unit have been set to the following values at the factory.

RS-232C parameters

Baud Rate: 9600 bps Word Bit Length: 8 bits

Parity: None Stop Bit Length: 1 bit

Connecting RS-232C cable

Precaution

Before connecting the cable, make sure the power switch on both data terminals and the VPS is OFF.

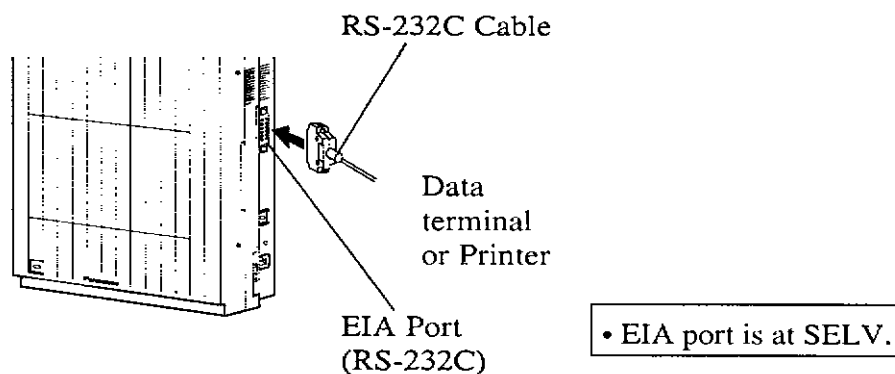

Insert the RS-232C cable into the VPS with the connector indicating the same direction.

2.2 Installation

Printer Connection

Make cables so that the printer may be connected to the VPS as shown in the chart. Cables must be shielded and the maximum length is 2 m (6.5 feet).

Connection Chart:

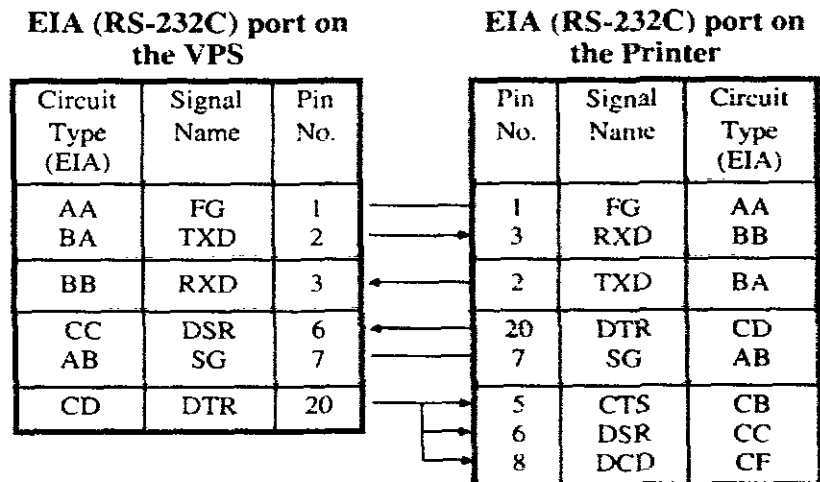

The pin configuration of the EIA (RS-232C) connector is as follows.

Pin Number	Signal Name		Circuit Type	
			EIA	CCITT
1	FG	Frame Ground Transmitted	AA	101
2	TXD	Data	BA	103
3	RXD	Received Data Request To	BB	104
4	RTS	Send	CA	105
6	DSR	Ready	CC	107
7	SG	Signal Ground Data Carrier	AB	102
8	DCD	Detect	CF	109
20	DTR	Data Terminal Ready	CD	108.2

2.2 Installation

EIA (RS-232C) SIGNALS:

Frame Ground (FG)

Connects to the unit frame and the earth ground conductor of the AC power cord.

Transmitted Data (TXD) (output)
Conveys signals from the unit to the printer (or terminal). A "Mark" condition is held unless data or BREAK signals are being transmitted.

Received Data (RXD) (input)
Conveys signals from the printer (or terminal).

Request To Send (RTS) (output)
This lead is held ON whenever DSR is ON.

Data Set Ready (DSR) (input)
An ON condition of circuit DSR indicates the printer (or terminal) is ready. Circuit DSR ON does not indicate that communication has been established with the printer.

Signal Ground (SG)

Connects to the DC ground of the unit for all interface signals.

Data Terminal Ready (DTR) (output)
This signal line is turned ON by the unit to indicate that it is ON LINE. Circuit DTR ON does not indicate that communication has been established with the printer (or terminal). It is switched OFF when the unit is OFF LINE.

Data Carrier Detect (DCD) (input)
The ON condition is an indication to data terminate (DTE) that the carrier signal is being received.

2.2 Installation

2.2.5 Power Cable Connection

Before connecting the power cable to an AC outlet, make sure all other connections (RS-232C data terminal with VPS, PBX with VPS, PBX with telephone lines) are secure. Use the AC outlet dedicated to the VPS unit.

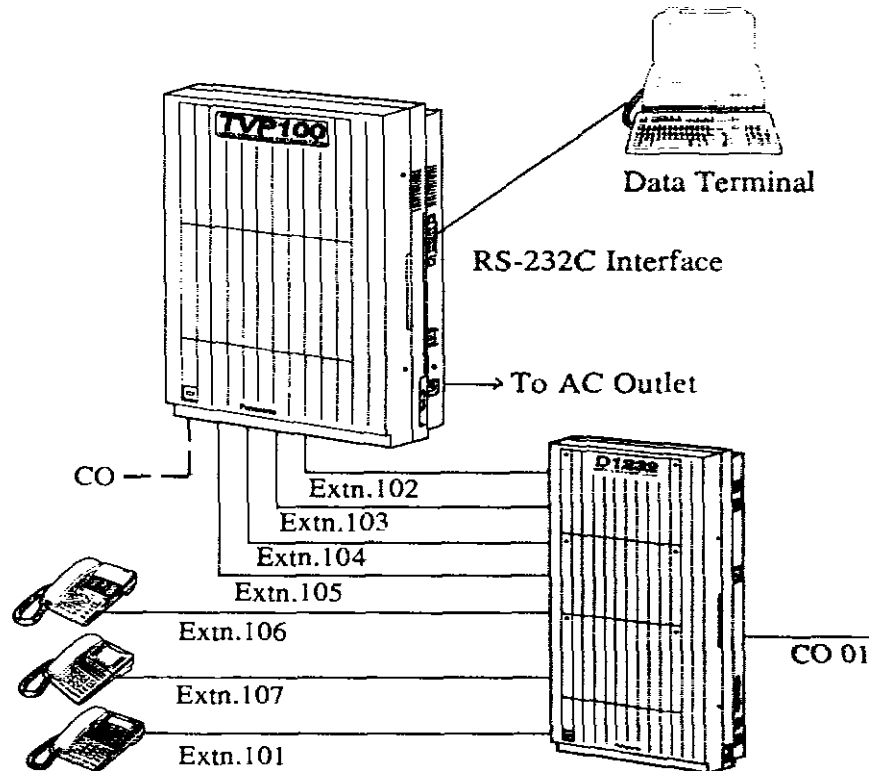

Note: When you operate this product, the mains socket outlet should be near the product and be easily accessible.

Chapter 3

Detailed Feature and Service Descriptions

This chapter describes all basic, optional, and programmable features in alphabetical order. It also provides information about the conditions, programming and operation required, related features, and operation for all features.

3 Features and Services

Before Reading This Chapter

In this chapter important features and services about the VPS are described in the following format.

Feature Ref.

Shows the master feature (service) of the feature (service).

Description

Describes the function of the feature (service) briefly.

More Information

Shows the features (services) to be referred to when you want to use the feature more efficiently and effectively. Each headline shows the name of the feature (service) so that you can look it up in Chapter 3 by headline.

Receive Message

Description The Subscriber can listen to the messages left in his Subscriber's mailbox.

More Information • **Reply to Message Sender**
After listening, you can reply

Reply to Message Sender

Feature Ref. Receive Message

The words "System Programming" and "Class of Service" will be frequently seen in this chapter and define the settings done by the System Administrator via data terminal. These settings can be partly done by the System Manager from a touch-tone telephone.

S.A.

Shows the pages to be referred to by the System Administrator to set the feature (service).

S.M.

Shows the pages for the System Manager's reference to set the feature (service).

M.M.

Shows the pages to be referred to by the Message Manager to use or set the feature (service).

Subscriber

Shows the pages to be referred to by the Subscriber to use or set the feature (service).

Conditions

Shows the conditions that must be satisfied to use the feature (service). Some features (services) can only be used exclusively and some require special setting before use.

3 Features and Services

A

Alternate Extension Group

Description Transfers the call coming in to the extensions in this group following the sequence specified by "Alternate Extension Transfer Sequence".

- S.A.**
- Alternate Extension Assignment (page 4-48)
 - "Alternate Extension Transfer Sequence" (page 4-80)

Auto Configuration (D-PITS Only)

Description The VPS can obtain extension numbers from a Panasonic KX- TD series telephone system to automatically create mailboxes.

- Conditions**
- This feature is available only when the D-PITS Voice Mail Integration with a Panasonic KX-TD series telephone system is activated.
 - All the mailboxes are numbered the same length. If your PBX provides extension numbers with three and four digits at the same time, the VPS attaches '0' to the end of the three digit numbers to make them to four digits.

- S.A.**
- "Integration Mode" (page 4-81)

Auto Forwarding

Description Messages that have not been listened to for a specified amount of time can be automatically forwarded or copied to another mailbox.

- Conditions**
- This service is available only to Subscribers.
 - Class of Service programming determines the mailboxes that can use this feature.
 - Messages marked as private cannot be forwarded.

- S.A.**
- "Authorization of Auto Forwarding" (page 4-34)

- S.M.**
- "Auto Forwarding Status" (page 5-10)

A

3 Features and Services

Automated Attendant Service

Description The Automated Attendant answers incoming calls and then routes the caller to the desired extension.
This service can be assigned on a port-by-port basis.

Calling the Automated Attendant

When the caller reaches the Automated Attendant service, he will first hear the following Automated Attendant service top menu.

*Please enter your party's extension.
To enter by name, press [#] and [1].
(For department dialing, press [*].)*

* The prompt in parentheses () is heard only when the Department Dialing feature is programmed and the prompts has been recorded beforehand.

Note: You can record the above prompt in other languages. Refer to "Recording User Prompts" in Chapter 6.

If the caller enters an extension number, the VPS transfers him to the specified extension automatically.

How to Access the Automated Attendant Service

- **VPS port**

Dial a telephone number connected to a VPS port which is assigned to the Automated Attendant service (see **Port Assignment**).

- **In the Custom Service**

Press a key which is assigned to the Automated Attendant service (see **Custom Service**).

* Dialing the service access command [#] [8] during a call enables the caller to access the Automated Attendant service whatever service he is in (**Service Access Commands**).

More

Information

- **Dialing by Name**

Entering the first three or four letters of the extension owner's last name after pressing [#] [1] also enables the caller to reach his desired extension.

3 Features and Services

A

- **Department Dialing**
Choosing an option among the department dialing menu also enables the caller to reach his desired extension.
- **Rotary Telephone Service**
Callers who are dialing from a rotary phone, or callers who are not familiar with VPS operation can be automatically transferred to the operator or General Delivery Mailbox.
System Programming determines which one the caller should be transferred.
- **Call Transfer Status**
The Subscriber (mailbox owner) can specify how the VPS should handle a call directed to his extension.
- **Incomplete Call Handling Service**
If the called extension is busy or if there is no answer, the caller is offered several options.
- **Hold**
When the line is busy, the caller has the option of redialing the extension.

S.A.

- "Incoming Call Service" (page 4-38)
- Department Dialing (page 4-40) / Operator's Parameters (page 4-41)
- Dialing Parameters (page 4-65) / Call Hold Parameters (page 4-70)
- Rotary Telephone Service (page 4-71)
- Intercom Paging Parameter (page 4-71)
- PBX Interface Parameters (page 4-78)

Subscriber

- Setting the Call Transfer Status (Subscriber's Guide page 5-2)
- Setting up a Covering Extension (Subscriber's Guide page 5-3)
- Setting the Incomplete Call Handling Status (Subscriber's Guide page 5-4)
- Setting the Message Reception Mode (Subscriber's Guide page 5-6)

A

3 Features and Services

Automated Attendant Service

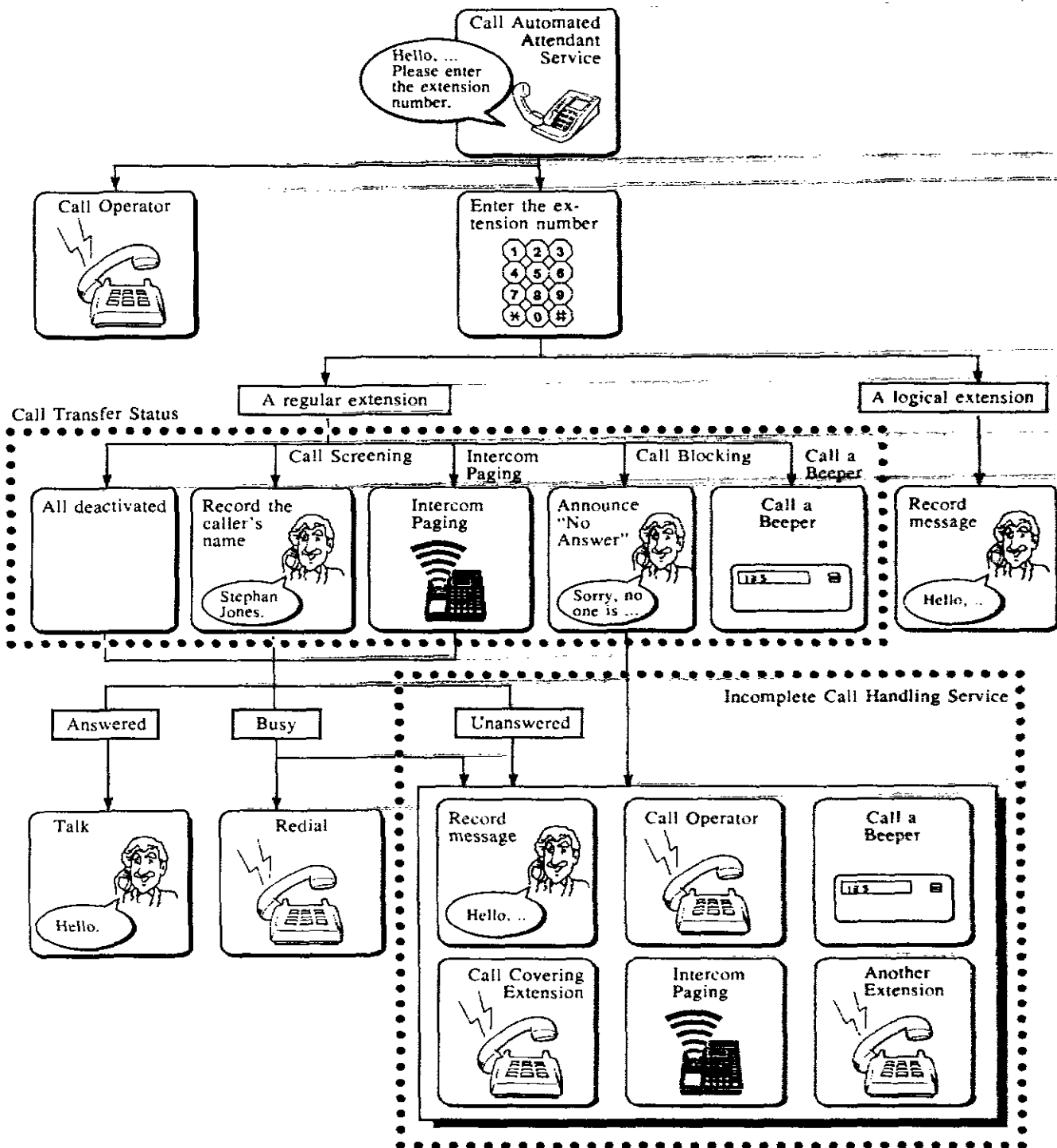

3 Features and Services

BC

Broadcasting Messages

Description Allows the System Manager to deliver an identical message to all of the Subscribers at the same time. This feature is useful to inform all Subscribers about current VPS status, such as remaining hard disk capacity, or to request them to delete unnecessary messages.

Conditions • This feature is available to the System Manager only.

S.M. • Delivering Messages to All Mailboxes (Broadcasting Messages)
(page 5-14)

Busy Coverage Mode

Feature Ref. Operator Service

Description Specifies the treatment of calls to the operator when the line is busy. Available options are:

1. **Hold**
The VPS calls the operator again while putting the caller on hold (see **Hold**).
2. **No-answer Coverage**
The caller is treated with the No-answer Coverage Mode setting (see **No-Answer Coverage Mode**).
3. **Call Waiting**
The VPS notifies the operator that another call is waiting by using the Call Waiting feature in the PBX.
4. **Disconnect Message**
The caller is disconnected from the VPS after hearing "*Thank you for calling*".

Conditions • Some PBXs do not support the Call Waiting feature.

S.A. • "Busy Coverage Mode" (page 4-43)

Callback Number Entry

Feature Ref. Message Waiting Notification-Device

Description When the caller records his message in a mailbox, the VPS asks him to enter his telephone number (Callback number). The number is played when the Subscriber accesses his mailbox. If the Subscriber receives the message waiting notification via beeper, the number is displayed on its LCD.

Note: The callback number is the number which the caller wishes you to callback.

There are five options in this mode. System Programming specifies one:

- (a) **Disable:** Deactivates this mode. Notification is made without the callback number display.
- (b) **Select:** The VPS asks the caller to enter a callback number only when the message is specified as urgent.
- (c) **Before:** The VPS asks the caller to enter a callback number before message recording.
- (d) **After:** The VPS asks the caller to enter a callback number after message recording.
- (e) **Without:** The VPS asks the caller only for the entry of a callback number. The caller cannot record a message.

When Busy or No-Answer

The VPS retries notification as many times as specified in "Retry Times". The callback number is displayed on the beeper only for the first set of retries.

- * If the message is recorded at the last moment of a notification time, the notification time may expire before the VPS starts calling. In this case, the callback number is never displayed even if it is entered correctly.

Conditions

- Only the Subscriber or the Message Manager who is authorized by Class of Service programming can use this feature.
- To use this feature, the following two conditions must be satisfied:
 - (a) The callback number display code must be included in the beeper number.
 - (b) The beeper is activated and it is within the notification time.
- To differentiate voice mail callback notification from regular beeper pages, it may be helpful to prefix the callback number with a one or two digit code of your choice.
- If the caller does not enter a callback number, the VPS displays the system callback number stored in the VPS.
- The VPS starts notification via the beeper immediately after the message with a callback number is recorded. Even if the VPS is attempting to retry notification of other messages, the attempt is canceled.

S.A.

- "Number to Dial" (page 4-23)
- "Beeper Callback No. Entry Mode" (page 4-33)
- "Outgoing Call Ports" (page 4-67)
 - "Max. Digits for Callback No." (page 4-67)
 - "Callback No. Entry Interdigit Time-Out" (page 4-67)
 - "System Callback No." (page 4-68)

3 Features and Services

C

- S.M.**
 - “Class of Service No.” (page 5-5)
 - “Message Notification Status” (page 5-9)
- M.M.**
 - Assigning Notification Numbers (page 6-8)
- Subscriber**
 - “Notification Number Assignment” (Subscriber's Guide page 5-15)

Call Blocking

See Call Transfer Status.

Call Screening

See Call Transfer Status.

Call Services

Description Consists of incoming and outgoing call services. Call service control functions include port assignment and Special Service Authorization.

- 1 Incoming Call Services**
 - (a) Automated Attendant Service
Routes the call to the desired extension.
 - (b) Voice Mail Service
Routes the call to the desired mailbox.
 - (c) Interview Service
Routes the call to an interview mailbox and the caller will hear questions stored there.
 - (d) Custom Service
Routes the call to the desired extension or mailbox by going down the tree-structured custom service menus.
- 2 Outgoing Call Services**
 - (a) Message Waiting Notification
Notifies the Subscriber that there are unplayed messages in his mailbox.
 - (b) External Message Delivery
Delivers a message to both Subscribers and Non-Subscribers.

More Information

- **Port Service**
System Programming determines per port basis with which service the VPS will answer incoming calls.

Call Transfer Status

Feature Ref. Automated Attendant Service

Description The Subscriber can specify how the VPS should handle a call before connecting it with his extension.
Four options are available: Call Screening, Call Blocking, Intercom Paging and Calling a Beeper.

Note: If no option is selected, calls are directly connected with the Subscriber's extension.

In this case, the Subscriber may:

- (a) take the call, or
- (b) not answer the call, or
- (c) be busy with another call.

In any event, the system will take appropriate action.

1. Call Screening

The Subscriber can decide whether or not to take a call by confirming the caller's name beforehand.

If this feature is activated, the caller hears:

Record your name at the tone.

When the call is transferred to the Subscriber's extension, the Subscriber hears:

*You have a call from (Name).
To answer the call, press [1].
Otherwise press [2]. and hang up.*

- To accept the call, press [1].
The call is transferred to the Subscriber's extension.
- To refuse the call, press [2].
The caller hears:

Sorry, no one is available to answer the call.

Then the caller hears Incomplete Call Handling Service menu message (see **Incomplete Call Handling Service**).

3 Features and Services

C

2. Call Blocking

The Subscriber can set the VPS to block all incoming calls to his extension. If this feature is activated, the caller hears:

Sorry, no one is available to answer the call.

The caller then hears the Incomplete Call Handling Service menu message.

3. Intercom Paging

By turning on this feature, the VPS permits callers to page a Subscriber over the Intercom Paging system of the PBX (see **Intercom Paging**).

If this feature is activated, the caller hears:

Please hold while I page your party.

Then the VPS pages the Subscriber:

There is a call for <Subscriber's Name>.

If answered within 20 seconds (default)*, the caller is connected to his intended extension:

* This time length can be changed by System Programming. See Intercom Paging Parameter (page 4-71).

If not, the caller hears:

Sorry, this pager is not available.

The caller then hears the Incomplete Call Handling service menu message.

Note: You can record the above prompt in other languages. Refer to "Recording User Prompts" in Chapter 6.

4. Calling a Beeper

If this feature is turned on, the VPS asks the caller to enter his telephone number for callback and prompts to hang up. The VPS will then call the Subscriber's beeper and display the callback number on the LCD (see **Callback Number Entry**).

Conditions • This feature is available to the Subscriber only.

Subscriber • Setting the Call Transfer Status (Subscriber's Guide page 5-2)

Class of Service

- Description** Used to define a set of services available to the Subscriber. Up to 64 different types of Class of Service can be established by System Programming. A Class of Service number can be assigned to each mailbox.
- Conditions** • Class of Service No. 63 is used for the Message Manager and No. 64 is for the System Manager.
- S.A.** • "Class of Service Number" (page 4-21)
 • Setting COS (Class of Service) Parameters (page 4-27)
- S.M.** • Setting COS (Class of Service) Parameters (page 5-7)

Company Greetings

- Description** Used to greet incoming callers to the VPS.
- The Company Greeting is assigned port-by-port and Day/Night basis by the System Administrator.
- If a company greeting is not recorded, the caller hears the following voice prompt.

*Good morning / Good afternoon / Good evening.
Welcome to the Voice Processing System.*

- Note:** You can record the above prompt in other languages. Refer to "Recording User Prompts" in Chapter 6.
- Conditions** • A total of 32 different Company Greetings can be recorded by the Message Manager.
- S.A.** • Port Assignment "Company Greeting No." (page 4-38)
 • Holiday Setting "Company Greeting Number" (page 4-60)
- M.M.** • Recording Company Greetings (page 6-12)

3 Features and Services

C

Covering Extension

Feature Ref. Incomplete Call Handling Service

Description Used to take a call to the Subscriber while he is not available to answer. This extension also acts as a personal operator. Pressing [0] while listening to the personal greeting of the mailbox allows the caller to reach this extension. This feature also works while recording a message.

This person should be someone who knows the Subscriber's whereabouts or the like.

Conditions

- If the Covering Extension is also busy or there is no answer, the caller will hear the Incomplete Call Handling service menu message arranged by the Covering Extension.
- A desirable Covering Extension must satisfy the following:
 - (a) Owns a mailbox.
 - (b) Is not a Logical Extension (see **Logical Extension**).
 - (c) Neither the Call Blocking nor Calling a Beeper is set as the Call Transfer Status (see **Call Transfer Status**).

S.A. • "Covering Extension" (page 4-21)

Subscriber

- Setting up a Covering Extension (Subscriber's Guide page 5-3)
- Setting the Incomplete Call Handling Status (Subscriber's Guide page 5-4)

Custom Service

Description **What is Custom Service?**
You can program your VPS to route incoming calls as you wish. When a caller reaches the Custom service, he will hear a menu message as below.

Ex. Menu Message...

*If you wish to speak with our General Manager, press [1].
For other people, press [2].*

The caller should press [1] to speak with the General Manager. Then the VPS connects him to the General Manager. If not, press [2]. Then another menu message will be heard. This way, the caller can reach their desired parties by answering up to eight menus.

How to Access a Custom Service

Dial an extension or telephone number which is connected to the Custom service port.

- Conditions**
- The VPS accommodates up to 100 menus.
 - The Message Manager must record Custom service menus in his own voice. If a menu is not recorded, the prompt "Custom Service Menu" is played.
 - Multi-Lingual service is available (see **Multi-Lingual Service**).
- S.A.**
- "Incoming Call Service" (page 4-38)
 - Custom Service (page 4-50)
- M.M.**
- Recording Custom Service Menu Messages (page 6-14)

[Programming Example]

As Custom service is so tailored, it is impossible to write all of potential examples in this manual. We will illustrate a short sample program with which we will show you how to create a Custom service in the VPS.

Suppose that you are a general manager of a distributor of office automation machines and tools. Most of your incoming calls are either orders for articles of consumption or requests for repair service. These calls have been increasing recently, so you decided to introduce a VPS to handle them instead of hiring an operator.

You want to transfer the calls for repair service directly to the engineers of the respective machines so that the caller can directly talk with the person in charge in detail about the situation of the machine.

On the other hand, you want to use an Interview mailbox to receive calls for purchase orders. Answering each question is the shortest way for callers to leave information required for purchase order.

1. Constructing a Tree

First of all, you should create a tree to design how to route incoming calls to the desired extension or mailbox. The drawing will help you to see the route at a glance. Please note that the tree should include all the options among which the caller can choose. The tree should not be deeper than eight layers.

The next figure shows the tree of the sample program.

You can see the structure of the tree on the display of your terminal using the Utility Command "CREP" (see **Utility Commands**).

3 Features and Services

C

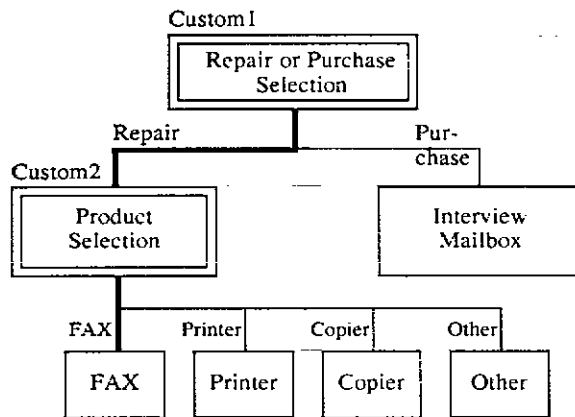

2. Filling the Worksheet

In each Custom service menu, you can:

- (a) assign one of 11 call transfer functions to each key of '0' to '9', '*' and '#'. These functions determine where the call should be transferred next.
- (b) define how to handle the call when there is no input. Chapter 4 describes the details of each parameter.

In addition to mailbox or extension numbers, you can assign another Custom service menu that contains different options. See Custom 1 in the above figure. If the caller chooses the repair service order, he will be transferred into Custom 2 in which he can choose his desired person.

In this way, Custom service will eliminate the need to transfer calls yourself.

Use the worksheet appears at the end of this manual when you specify these parameters. If you have filled in the worksheet beforehand, the input operations will go smoother and quicker.

■ Worksheets of Sample Program

System Administration Top Menu → 1 → 4 → 2

Custom No.	Description	Prompt Mode	Menu Repeat Cycle	Call Transfer Anytime	Wait for Second Digit	No DTMF Input Operation	Keypad Assignment
1-100	Up to 32 alphanumeric characters	System User 1 User 2	1 - 3 times	Extn. Mbx No	1- 5 seconds	a: Transfer to Mailbox b: Transfer to Extension c: Operator d: Exit e: Previous Menu f: Custom Service	a: Transfer to Mailbox b: Transfer to Extension c: Operator d: Exit e: Previous Menu f: Custom Service g: Voice Mail Service h: Call Transfer Service i: Subscriber Service j: Department Dialing k: Dial by Name l: Repeat Menu m: Main Menu n: Fax Transfer
1	REPAIR OR PURCHASE	System	3	Extn.	1	C	1: f, 2 2: 3: 4: 5: 6: 7: 8: 9: *: d 0: c #:
2	PRODUCT SELECTION	System	3	Extn.	1	C	1: b, 100 2: b, 101 3: b, 102 4: b, 103 5: 6: 7: 8: 9: *: d 0: c #:

3. Input the Custom Service Menus

The System Administrator is responsible for the actual input operations of the Custom service menus.

Fill in the worksheets and enter the values in each parameter referring to your worksheet.

Note: If you set "i: Subscriber Service" to [*], the Subscriber can enter the Subscriber's service by pressing [*] + mailbox number. This is the same image as in the Voice Mail service.

3 Features and Services



■ Custom Service Settings Screen for Sample Program

Custom 1

```

Program – Service Setting – Custom Service Setting – Custom 1
Description ----- : REPAIR OR PURCHASE
:
Prompt Mode (1. Sys 2: User 1 3: User 2) ---- : System
Menu Repeat Cycle (1-3)----- : 3 times
Call Transfer Anytime (Extn. / Mbx / No)----- : Extn.
Wait for Second Digit (1-5 seconds) ----- : 1 seconds
No DTMF Input Operation (a-f)----- : c
Keypad Assignment
1: f, Custom 2          2: a, mailbox no. 300    3:
4:                      5:                      6:
7:                      8:                      9:
*: d                    0: c                      #:
Please choose one of the following functions or services.
a. Transfer to Mailbox          h. Call Transfer Service
b. Transfer to Extension        i. Subscriber Service
c. Operator                     j. Department Dialing
d. Exit                         k. Dial by Name
e. Previous Menu               l. Repeat Menu
f. Custom Service              m. Main Menu
g. Voice Mail Service          n. Fax Transfer
    
```

Custom 2

```

Program – Service Setting – Custom Service Setting – Custom 2
Description ----- : PRODUCT SELECTION
:
Prompt Mode (1. Sys 2: User 1 3: User 2) ---- : System
Menu Repeat Cycle (1-3)----- : 3 times
Call Transfer Anytime (Extn. / Mbx / No)----- : Extn.
Wait for Second Digit (1-5 seconds) ----- : 1 seconds
No DTMF Input Operation (a-f)----- : c
Keypad Assignment
1: b, extn. no. 100      2: b, extn. no. 101    3: b, extn. no. 102
4: b, extn. no. 103      5:                      6:
7:                      8:                      9:
*: d                    0: c                      #:
Please choose one of the following functions or service.
a. Transfer to Mailbox          h. Call Transfer Service
b. Transfer to Extension        i. Subscriber Service
:                               :
:                               :
:                               :
    
```

Note: “ **Custom 2** ” indicates that menu messages of Custom 2 are recorded by the Message Manager.

4. Recording the Menu Messages

Once the System Administrator finishes entering parameters into all of the menus, next is recording the menu messages.

The menu messages can be the only clue for callers to select an option to which they are transferred. Considering this, you have to make a menu message which contains all of the potential options available for the caller.

The recording of menu messages is carried out by the Message Manager. Access the Message Manager's service and choose "Recording Custom Service Menu Messages".

You will hear the following prompt:

*Enter the custom service prompt number [1] through [100].
To record custom service exit prompt, press [0].*

Enter the menu messages for Custom 1 and Custom 2 as below.

■ Menu Messages of the Sample Program

Custom Number	Menu Message
1	<i>For repair service orders, press [1]. For purchase orders, press [2].</i>
2	<i>For facsimiles, press [1]. For printers, press [2]. For copiers, press [3]. For other machines, press [4].</i>

5. Checking the Program

After you finish both entering and recording all menus, it is important to check your program if there are any problems for the caller. Check if the call is transferred as you have planned, if there is any menu message that has not been recorded, and the like. You should check it thoroughly comparing with the tree or worksheet.

You have to also check if you have assigned the operation for rotary phone callers.

3 Features and Services

D

Day Service

Description Sets the parameters, below to handle incoming calls properly during the respective daytime and nighttime hours.

- “Company Greeting No.” (page 4-38)
- “Incoming Call Service” (page 4-38)
- “Incoming Call Service Prompt” (page 4-38)
- “Delayed Answer Time” (page 4-38)
- Operator’s Parameters (page 4-41)

Conditions • These settings are ignored on days specified as holidays. On holidays, special settings for holidays are provided whole day (see **Holiday Service**).

S.A. • Day Service (page 4-57)

Daylight Saving Time Assignment

Description Adjusts the internal clock for the starting and ending day of Daylight Savings Time.

S.A. • “Start Date / End Date” (page 4-61)

Department Dialing

Feature Ref. Automated Attendant Service

Description This is a speed dialing function.
Allows the caller to access his desired extension by simply dialing a one digit number (1–9) during or after hearing the Department Dialing menu message.

Conditions Department Dialing menu message is played to the caller in the following cases;

- When the caller accesses the Automated Attendant service.
- When the caller dials [#] [3] during a call (see **Service Access Commands**).

S.A. • Department Dialing (page 4-40)

M.M. • Recording Department Dialing Menu Messages (page 6-13)

D

3 Features and Services

Dialing by Name

Feature Ref. Automated Attendant Service

Description Allows the caller to reach the desired extension or mailbox by entering the first three or four letters of the extension owner's last name. The VPS will play the possible names among the Subscribers and ask the caller if it is the desired party one after another.

The caller should enter [#] [1] and press the corresponding buttons. For example, to call Mr. Smith, enter [#] [1] and [7] [6] [4] [8] for [S] [M] [I] [T].

Each digit of the telephone keypad (touch-tone telephone only) corresponds to alphabetical characters as follows.

1	ABC 2	DEF 3
GHI 4	JKL 5	MNO 6
PRS 7	TUV 8	WXY 9
* *	0	#

Note: To enter the letter Q, press [7].
To enter the letter Z, press [9].

Conditions This feature is not available if the extension owner's last name was not registered by the System Administrator or the System Manager beforehand.

S.A. • "Owner Name, Last" (page 4-21)

S.M. • "Initial 3 or 4 Letters of Subscriber's Last Name" (page 5-5)

3 Features and Services

D

Direct Mailbox Access (D-PITS Only)

Feature Ref. Voice Mail Service

Description Allows the Subscriber to access his mailbox without entering the mailbox number.

Conditions

- The Subscriber must be calling from his extension.
- This feature is available only when the D-PITS Voice Mail Integration with a Panasonic KX-TD series telephone system is activated.
- The Subscriber may be asked to enter the correct password.
- Class of Service programming determines which extensions this feature is available on.

S.A.

- "Direct Mailbox Access" (page 4-29)
- "PBX Type" (page 4-79) / "Integration Mode" (page 4-81)

S.M.

- "Direct Mailbox Access Status" (page 5-9)

D-PITS

Feature Ref. PBX Integration

Description Your PBX sends the VPS the information and commands on the calling extension via D-PITS interfaced data link to help it work more effectively. Using the information and commands, the VPS can: (a) identify the extension number of the caller; (b) know where the call is forwarded from and its line status; (c) recognize what the caller wants to do.
The following features are available only with D-PITS Voice Mail Integration.

- **Auto Configuration**
- **Direct Mailbox Access**
- **Intercom Paging**
- **Live Call Screening**
- **Two-Way Recording**

Conditions

- This feature can be activated only when your PBX is a Panasonic KX-TD series telephone system and the system supports D-PITS Integration.

S.A.

- Dialing Parameters (page 4-78)

E

3

Features and Services

Extension Group

Description A number of extensions can be grouped together as an extension group. They can own the same mailbox to share the same information. Up to 20 extension groups can be created in the system and each group can contain a maximum 20 extensions.

Conditions

- A Subscriber cannot have more than one mailbox.
- The VPS turns on the Message Waiting Notification Lamp on each extension when a message is left in the mailbox (see **Message Waiting Notification-Lamp**).

S.A. • Extension Group (page 4-55)

Extension Numbering Plan

Description Specifies the first one or two digits of the extension numbers in your PBX so that the VPS can recognize the extension number as a valid one.

S.A. • Extension Numbering Plan (page 4-63)

External Message Delivery List

Feature Ref. External Message Delivery Service

Description Allows the Subscriber to deliver an external delivery message to multiple destinations with a single operation.

Conditions

- The Subscriber can maintain up to two lists.
- One External Message Delivery List accommodates up to eight entries.
- When the Subscriber changes some of the entries in a list, the delivery programs using the old list is canceled.

Subscriber • Setting up an External Message Delivery List (Subscriber's Guide page 3-4)

External Message Delivery Service

Description Allows the Subscriber to deliver a message to anyone including the Non-Subscriber. The VPS rings the telephone and plays the message directly to the receiver.

A password can be assigned, if necessary, to protect the message from being received by some other person. The Subscriber can also specify the date and

3 Features and Services

E

time for delivery. Otherwise, the message is delivered immediately after being recorded.

After listening to the message, the receiver can reply to the Subscriber without specifying the mailbox number (see **Reply to Message Sender**).

If the receiver does not have a time to receive the message at that moment, it is possible to have the VPS call him back later.

When Busy or No Answer

The VPS calls the receiver as many times as specified by "Retry Times Setting".

More

Information

- **External Message Delivery List**
You can send an identical message to several parties with a single operation.
- **External Message Delivery Status**
You can check the distribution status of the external delivery messages, cancel unnecessary messages and change their settings.
- **Message Delivery, Internal**
If you are sending your message only to Subscribers, you can send the message to their mailboxes.

Conditions

- This feature is available only to Subscribers.
- Class of Service programming determines which Subscriber can use this feature.
- The delivery date should be a date within one month after message recording.
- If the receiver fails to enter the correct password within three tries, the VPS disconnects the line after playing the company telephone number so that the receiver can make a call later.
- If a message has not been delivered within the time tries by "Message Retention Time" measured from the delivery date, it is automatically deleted.

S.A

- "Class of Service Number" (page 4-21)
- "Authorization of External Message Delivery" (page 4-34) / "Prompt Mode" (page 4-34)
- External Message Delivery Parameters (page 4-68)

S.M.

- "External Message Delivery Status" (page 5-10)

Subscriber

- Sending External Delivery Messages (Subscriber's Guide page 3-6)

External Message Delivery Status

Feature Ref. External Message Delivery Service

Description Allows the Subscriber to check distribution status of undelivered and pending external delivery messages. Unnecessary messages can be deleted. The settings (destination number, voice-recorded receiver's name, password assignment or delivery schedule) can also be changed.

The VPS reports the following in a voice announcement.

- a) Voice-recorded receiver's name
- b) Delivery schedule

Conditions

- No reports are provided on the messages which have been already delivered to the destinations.
- If the destination of the message is an External Message Delivery List, the Subscriber can check the status of each respective member.

Subscriber

- Checking and Setting External Message Delivery Status (Subscriber's Guide page 3-7)

Fax Management

Description When receiving a fax signal (CNG Signaling) from incoming calls, the VPS has a function to transfer the call automatically to a specified fax machine.

Conditions

- Up to two fax machines can be assigned.
- If the VPS fails to connect a call to the first fax machine, the call will be transferred automatically to an alternate one. If notification to the second machine also fails, the VPS will:
 - (a) leave a message in the Fax Manager's mailbox
 - (b) call the extension which belongs to Fax Manager's mailbox
 - (c) take no action
- * Defined by the Fax No-answer Coverage Mode.
- The VPS reports the result to the Fax Manager.
- The reports show only how the calls were handled, but do not show whether the fax messages have been properly received.

S.A.

- Fax Management (page 4-73)

3 Features and Services

G

Group Distribution List, Personal

Feature Ref. Message Delivery, Internal
Message Transfer

Description Subscribers may sometimes want to simultaneously send a message to several mailboxes. These mailboxes can be put together into a list. If the Subscriber specifies the list as the destination, he can send the same message to one or more destinations with a single operation.

Conditions

- This feature is available only to Subscribers.
- Up to four lists can be set up by each Subscriber.
- Each list accommodates up to 20 entries.

Subscriber

- Entry of Personal Group Distribution Lists
(Subscriber's Guide page 5-10)
- Recording the Names of Personal Group Distribution Lists
(Subscriber's Guide page 5-11)
- Deleting from Personal Group Distribution lists
(Subscriber's Guide page 5-12)

Group Distribution List, System

Feature Ref. Message Delivery, Internal
Message Transfer

Description Subscribers may sometimes want to simultaneously send a message to several mailboxes. These mailboxes can be put together into one list. These lists are set up by the System Administrator and commonly used by all Subscribers, System Manager and Message Manager in the system.

Conditions

- The VPS accommodates up to 20 lists.
- Each list accommodates up to 20 entries.
- The list number should be the same number of digits as the mailbox number.

S.A. • Mailbox Group (page 4-53)

M.M. • Recording Voice Labels for Mailbox Lists (page 6-15)

Hold

Feature Ref. Incomplete Call Handling Service

Description When the specified extension is busy, the caller has the option of holding the call temporarily. After a short period, the VPS will call the extension again. If several callers are holding their calls to be connected to the same extension, they will be connected in the order in which they were received. The VPS will announce how many people are waiting. For example, "*Sorry, three people are waiting to connect. If you would like to hold, press [2].*"

Conditions

- It is possible to deactivate a call hold.
- It is possible to deactivate the call queuing announcement.

S.A. • Call Hold Parameters (page 4-70)

Holiday Service

Feature Ref. Day Service

Description The VPS will provide another service and Company Greetings on days specified as holidays.

Conditions

- You can program the special service mode for up to 20 holidays.
- The System Administrator defines whether the settings are canceled or maintained after the holiday is over.
- This service is effective only for specified ports. On these ports, the Day service setting is ignored. Other ports provide the usual Day service.

S.A. • Holiday Setting (page 4-58)

Inband

Feature Ref. PBX Integration

Description With Inband Integration, the PBX sends certain information to the VPS with DTMF tone.

Inband Integration can be categorized into the following two types:

(a) Voice Mail Integration

This integration works together with Call Forwarding feature of the PBX. And you have to set the station hunting type of your PBX to VM mode.

3 Features and Services

I

When activated, the PBX sends the digits of the mailbox number of the called extension with DTMF tone to the VPS before connecting the caller.

These digits are commonly known as the Follow-on ID.

As a result, the caller who does not know the mailbox number of the called extension can leave a message.

(b) **DTMF tone Integration**

This integration works together with Automated Attendant service of the VPS.

When activated, the PBX informs the VPS of the state of the call (busy, answered, ringing, etc.) by sending a code with DTMF tone before sending the normal call progress tone (busy tone, ringback tone, etc.). These codes enable the VPS to immediately recognize the current state of the call and improve its call handling performance.

Conditions

- Each code must be set in System Programming according to the PBX codes.
- If your PBX is a Panasonic KX-T series telephone system, the Inband Integration codes will automatically default to the proper codes.

S.A.

- Dialing Parameters (page 4-78)
- Inband Signaling Parameters (page 4-83)
- Digit Translation Table Parameters (page 4-85)

[Example of Inband Integration]

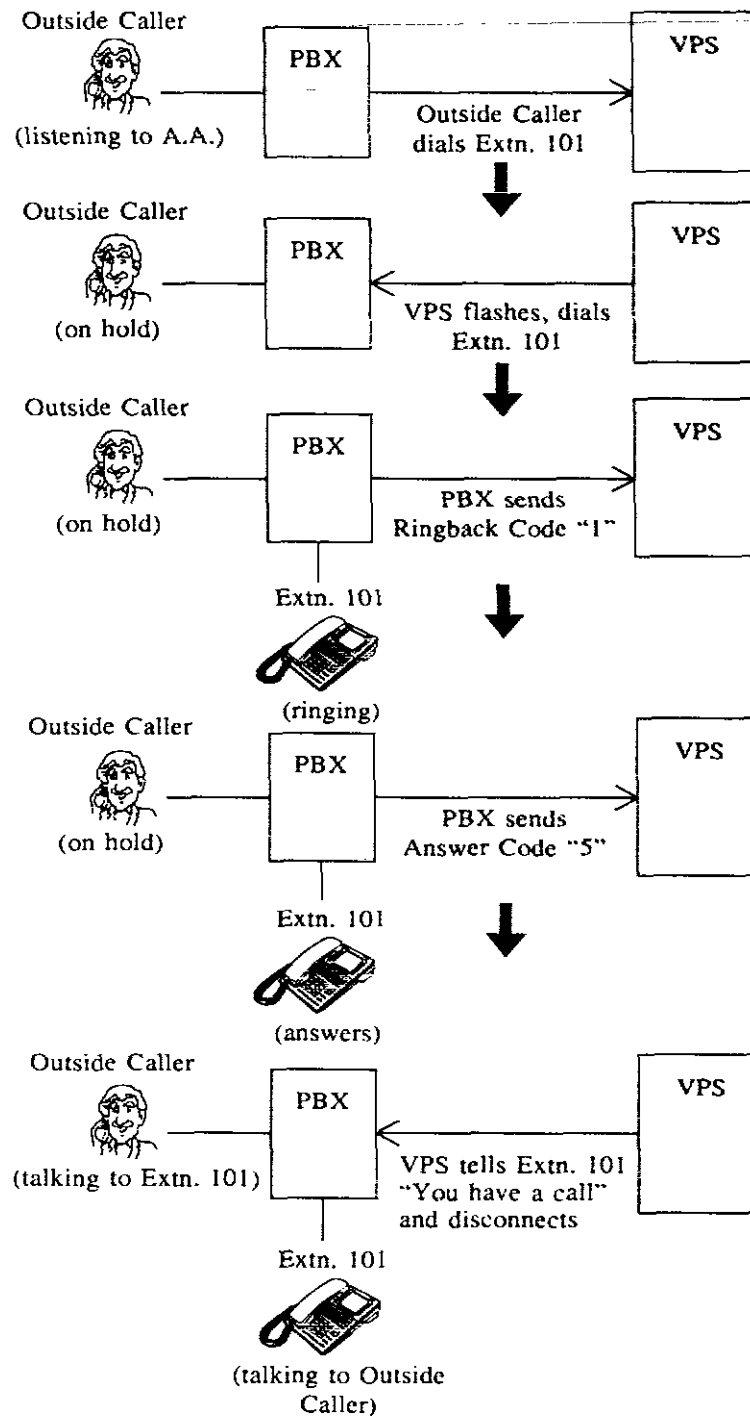

3 Features and Services

I

Incomplete Call Handling Service

Feature Ref. Automated Attendant Service

Description If a caller specifies an extension which is busy or has no answer, the VPS will offer the Incomplete Call Handling Services. The Subscriber specifies options to offer:

1 Leaving a Message

The caller can leave a voice message in the mailbox or the interview mailbox of the extension (see **Message Reception Mode**).

- * If the extension does not have a mailbox (Non-Subscriber), the caller is transferred to the General Delivery Mailbox where he can leave a message.
- * Check the mailbox capacity regularly to make sure that there is enough area to record additional messages.

2 Transfer to Covering Extension

See **Covering Extension**.

3 Returning to the Automated Attendant Top Menu

The caller hears the Automated Attendant initial menu again, and can call another extension.

4 Intercom Paging

See **Call Transfer Status and Intercom Paging**.

5 Calling a Beeper

See **Call Transfer Status and Callback Number Entry**.

6 Calling Operators

See **Operator Service**.

- * If the Operator 1 is not available to answer the call, the caller will receive instructions defined by System Programming (see **Busy Coverage Mode/No-answer Coverage Mode**).

How the VPS Works

The caller who enters this service will hear the following voice prompt.

(To leave a message, press [1].)
(To reach the covering extension, press [2].)
(To page your party, press [3].)
(To notify your party's beeper, press [4].)
(To call the operator, press [0].)
(To enter another extension, press [].)*

The caller chooses one of these options by pressing a key.

I

3 Features and Services

- * The prompts in parentheses () are heard only when that option is activated.
- * Callers will not hear this prompt if there is only one option available.

Note: The above prompt can be recorded in other languages. Refer to "Recording User Prompts" in Chapter 6.

More

Information

• Hold

In case the line is busy, the caller may hold a call before entering this service. Then the VPS will call the extension again later on.

Conditions

- This feature is available to Subscribers only.
- If the specified extension is not a Subscriber, callers will always hear the following three options.
 - a) Leaving a message
 - b) Returning to the Automated Attendant top menu
 - c) Calling operators
- If none of the options is activated, the call will be disconnected.

Subscriber

- Setting up a Covering Extension (Subscriber's Guide page 5-3)
- Setting the Incomplete Call Handling Status (Subscriber's Guide page 5-4)

Intercom Paging (D-PITS Only)

Feature Ref.

Call Transfer Status
Incomplete Call Handling Service

Description

Callers can page Subscribers through built-in speakers and external paging equipments.

Conditions

- This feature is available only when the D-PITS Integration with a Panasonic KX-TD series telephone system is activated.
- The VPS must be integrated with your PBX in the specified mode.
- Speakers used for paging are determined by System Programming.

S.A.

- "Intercom Paging Group" (page 4-30)
- Intercom Paging Parameter (page 4-71)
- "Integration Mode" (page 4-81)

S.M.

- "Intercom Paging Group Number" (page 5-9)

Subscriber

- Setting the Call Transfer Status (Subscriber's Guide page 5-2)
- Setting the Incomplete Call Handling Status (Subscriber's Guide page 5-4)

3 Features and Services

I

Interview Service

Description When a caller accesses this service, a set of questions recorded in the Interview mailbox is announced to the caller. This service is useful to make inquiries or to receive repair service orders.

How to Assign the Interview Service

This service can be not only assigned to a VPS port as an independent service, but also can be used in combination with other services.

1. VPS Port

If you assign an Interview mailbox number to a VPS port, all calls to this port will be answered by the Interview mailbox and asked the questions stored there (see **Port Service**).

2. Voice Mail Service

Callers can directly access the Interview Service by entering an Interview mailbox number.

3. Automated Attendant Service

Each Subscriber can assign his Interview mailbox to receive the messages when the Subscriber is unavailable to answer the call (see **Incomplete Call Handling Service** "Leaving a Message").

4. Custom Service

An Interview mailbox number can be assigned to a key as the destination of the call transfer (see **Custom Service**).

Conditions

- Mailbox programming determines which Subscriber can own an Interview mailbox.
- The questions are recorded by the Subscriber.
- Up to ten questions can be recorded in an Interview mailbox.

S.A. • "Interview Mailbox No." (page 4-21)

S.M. • "Interview Mailbox No." (page 5-5)

Subscriber

- Setting Answer Lengths for the Interview Mailbox (Subscriber's Guide page 5-16)
- Recording Questions for the Interview Mailbox (Subscriber's Guide page 5-17)
- Erasing Questions from the Interview Mailbox (Subscriber's Guide page 5-18)

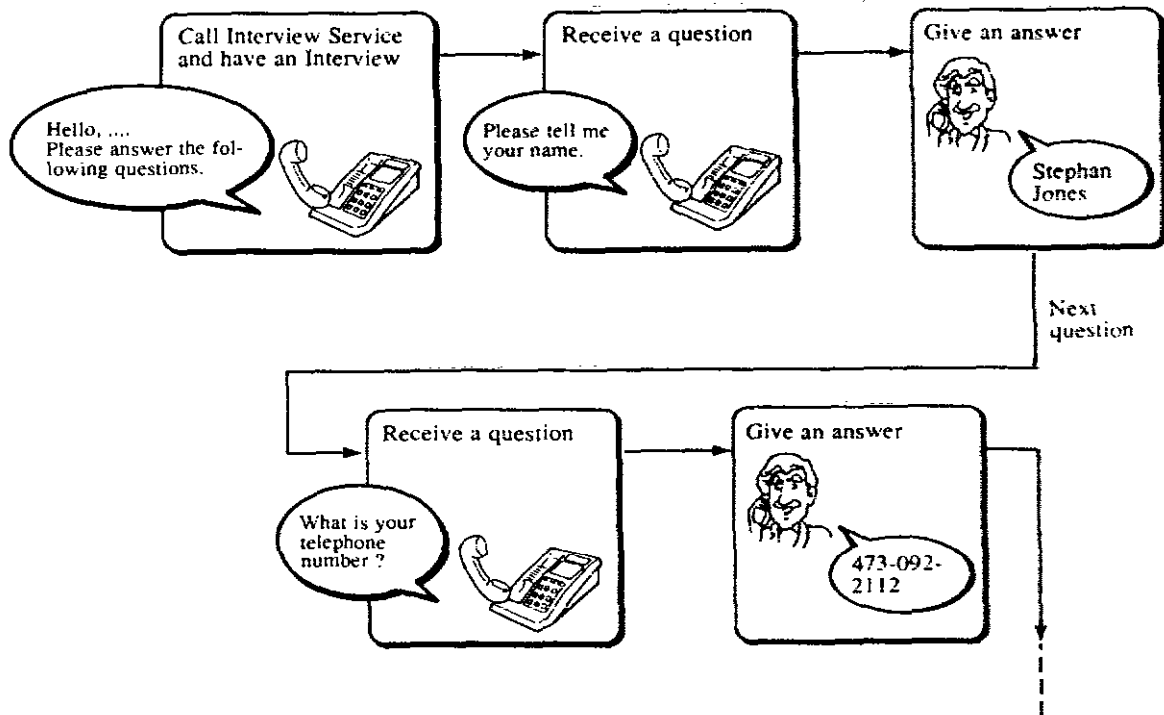

Live Call Screening (D-PITS Only)

Description The Subscriber can decide whether or not to answer a call by monitoring incoming calls that are being recorded in his mailbox.

There are two modes for this feature:

(a) **Hands-Free Mode**

When a caller starts to record a message, the caller's voice is heard from the built-in speaker of the telephone; the Subscriber can talk to the caller by picking up the handset.

(b) **Private Mode**

When a caller starts to record a message, a notification tone is heard from the telephone. If the Subscriber goes off-hook, he can monitor the caller's voice. Furthermore, he can talk to the caller by pressing the feature button. Also, he can stop listening to the message by going on-hook.

Conditions

- This feature is available only if D-PITS Voice Mail Integration with a Panasonic KX-TD series telephone system is activated, which provides a feature button for Live Call Screening.
- If the Subscriber answers the call, the VPS stops recording according to the PBX programming; when he starts to talk or when he finishes the conversation. It is possible to cancel the recorded conversation, depending upon the COS parameter setting.

3 Features and Services

LM

- S.A.**
- “Class of Service Number” (page 4-21)
 - “Message Cancel for Live Call Screening” (page 4-29)
 - “PBX Type” (page 4-79) / “Integration Mode” (page 4-81)
- S.M.**
- “Message Cancel for Live Call Screening Status” (page 5-9)
- Subscriber**
- Live Call Screening (Subscriber's Guide page 2-9)

Logical Extension (All Calls Transfer to Mailbox)

Description A Logical Extension is not a real extension of a PBX. All calls to this type of extension always land in a mailbox.

Conditions

- This feature is useful for the Subscriber who has little opportunity to receive a call directly because he is often outside his office.
- “Mailbox Settings” programming determines which mailboxes can use this feature.

S.A.

- “All Calls Transfer to Mailbox” (page 4-22)

S.M.

- “All Calls Transfer to Mailbox” (page 5-5)

Mailbox

Feature Ref. Voice Mail Service

Description A mailbox receives messages sent to the Subscriber. Subscribers can also send messages through the mailbox. The VPS accommodates up to 64 mailboxes including the System Manager’s mailbox and the Message Manager’s mailbox.

Subscriber’s Mailbox

Up to 62 Subscriber’s mailboxes can be assigned. The Subscriber’s mailbox allows any caller to leave a message and also allows the Subscriber to gain access to a variety of Subscriber services (see **Voice Mail Service**).

A Subscriber’s mailbox may have a sub-mailbox called an Interview mailbox.

- * Mailboxes in an extension group can own one mailbox together in order to share the same information (see **Extension Group**).
- * It is possible to assign a Subscriber’s mailbox to a person who does not have any extension of your PBX (see **Logical Extension**).

Interview Mailbox

This mailbox is a sub-mailbox of the Subscriber's mailbox. To use this mailbox, the Subscriber needs to get authorization by System Programming. When a caller accesses this mailbox, a series of questions are asked. He can leave his answers, responding to each question. These questions will be recorded by the Subscriber.

The answers are recorded in a string in the associated Subscriber's mailbox and can be received together with other messages.

System Manager's Mailbox

This is a special mailbox for the System Manager, who is in charge of the overall operation of the VPS after it is fully installed and programmed. By accessing this mailbox, the System Manager performs a variety of System Manager services (see **Voice Mail Service**). Any caller, of course, can leave messages.

Message Manager's Mailbox

This is a special mailbox for the Message Manager, who is in charge of managing the various voice prompts commonly used in the whole system. By accessing this mailbox, the Message Manager performs a variety of Message Manager services (see **Voice Mail Service**). Any caller, of course, can leave messages.

This mailbox also works as the General Delivery Mailbox.

General Delivery Mailbox

Callers who are not familiar with Voice Mail operation, or who are calling from rotary telephones are transferred to this mailbox where they can leave messages. Messages left in this mailbox are received by the Message Manager and then transferred to each Subscriber. The General Delivery Mailbox and the Message Manager's mailbox are one and the same.

Creating a Mailbox

The System Administrator or the System Manager creates Subscriber's mailboxes. Usually, the Subscriber's extension number is assigned as the mailbox number.

On the other hand, the System Manager's mailbox and the Message Manager's mailbox have been already installed in the VPS at the factory with the following numbers.

Number of Digits	2	3	4	5
System Manager's Mailbox Number	99	999	9999	99999
Message Manager's Mailbox Number	98	998	9998	99998

3 Features and Services



* Number of Digits is determined by System Programming (see page 7-23). The default value is set to three digits at the factory.

Mailbox Capacity

The following five parameters determine how many messages one mailbox accommodates at a time. The System Administrator or the System Manager sets them according to the Subscriber's demand and disk capacity.

	Setting Range	Subscriber's Mailbox (default)	System and Message Manager's Mailbox (default)
New Message Retention Time	1-30 days	5	30
Saved Message Retention Time	1-30 days 0:Unlimited	5	30
Max. Length of One Message	1-6 min.	3	6
Maximum Messages	5-100 msgs	10	100
Max. Length of All Messages Combined	5-100 min.	10	100

* If the Auto Forwarding feature is authorized by System Programming, messages that have not been heard (New Messages) are automatically transferred to another mailbox after a specified length of time (see **Auto Forwarding**).

S.A.

- Setting up Mailboxes (page 4-19)
- "New Message Retention Time" (page 4-28)
- "Saved Message Retention Time" (page 4-28)
- "Message Length" (page 4-28)
- "Mailbox Capacity Maximum Messages" (page 4-28)
- "Mailbox Capacity Maximum Message Time" (page 4-28)

S.M.

- Setting up Mailboxes (page 5-4)
- "New Message Retention Time" (page 5-7)
- "Saved Message Retention Time" (page 5-7)
- "Message Length" (page 5-8)
- "Number of Messages" (page 5-8) / "Total Message Time" (page 5-8)

Mailbox Group

See **Group Distribution List, System**.

Message Delivery, Internal

Description The VPS automatically delivers a single message to multiple mailboxes with a single operation. As a destination, it is possible to specify a System Group Distribution List or a Personal Distribution Group List as well as a mailbox number. The Subscriber can specify the date and time for delivery. Otherwise, the message is delivered immediately after being recorded. Also the message can be specified as private to prevent it being transferred to other mailboxes by the receiving Subscriber.

More

Information

- **Private Message**
You can specify your message as private.
- **Group Distribution List, System, Group Distribution List, Personal**
You can send an identical message to several Subscribers with a single operation.
- **Message Delivery Status**
You can check if the message has been already sent to the destination.
- **External Message Delivery**
You can directly send your message to both Subscribers and Non-Subscribers.

Conditions

- This feature is only available to the System Manager and the Subscriber.
- Up to 20 mailboxes can be specified as destinations. For example, if a Personal Distribution Group List which contains eight members has been already specified, there is room for 12 more mailboxes.

S.M.

- Delivering Messages to Specified Mailboxes (page 5-14)

Subscriber

- Delivering Messages to Other Subscribers (Subscriber's Guide page 3-2)

Message Delivery Status

Feature Ref. Message Delivery, Internal

Description

Allows the Subscriber to check the delivery status of a message per mailbox basis. After checking, he can cancel any unnecessary messages. If the receiving Subscriber has not listened to the message, the VPS reports the following in a voice announcement.

- a) When the message was recorded.
- b) Mailbox number of the destination.
- c) The message.

If the message has been already listened to, the VPS reports when it is listened.

3 Features and Services

M

- Conditions**
- Up to 84 message delivery statuses can be stored.
 - One delivery status is for one recipient (mailbox). When multiple mailboxes, for example, a Group Distribution List, are specified, each mailbox has a delivery status.
 - A message delivery status is automatically erased on condition that:
 - a) the message was delivered and the Subscriber has listened to its delivery status.
 - b) the Subscriber cancels the delivery.
 - c) when the mailbox already holds 84 delivery statuses. In this case, the oldest status is erased when a new message is recorded.
 - * The Subscriber can erase unnecessary statuses himself.
 - * To keep the oldest delivery status, delete any unnecessary one before sending a new message.
 - To cancel a delivery, its delivery status must exist without being erased.
 - A message which has been already delivered can be canceled only if it has not been listened to.
 - As for a Group Distribution List, you can cancel the message delivery on a mailbox basis.

- S.M.**
- Checking Mailbox Distribution (page 5-15)

- Subscriber**
- Checking Mailbox Distribution (Subscriber's Guide page 3-3)

Message Reception Mode

Description The Subscriber can specify whether callers are directed to the regular mailbox or the Interview mailbox when he is unable to take calls.

- Subscriber**
- Setting the Message Reception Mode (Subscriber's Guide page 5-6)

Message Scan

Feature Ref. Receive Message —

Description The Subscriber can listen to only the first four seconds of each message. While scanning, pressing the corresponding key allows the Subscriber to receive the entire message. He can also receive the message recording information; date and time of recording and message sender's name.

Conditions

- System Programming determines which Subscriber can receive the message recording information.

- S.A.**
- "Message Scanning with Information" (page 4-28)

- S.M. • "Message Scanning with Information" (page 5-8)
- Subscriber • Message Playback Options (Subscriber's Guide Page 2-3)

Message Transfer

Feature Ref. Receive Message

Description Allows the Subscriber to transfer a message left in his mailbox to other mailboxes immediately after listening.
As destinations, one or more mailboxes can be specified. It is possible to put some comment to the top of the message.

More Information • **Group Distribution List, System, Group Distribution List, Personal**
You can transfer a message to several Subscribers with a single operation.

Conditions • This feature is also available to the System Manager and the Message Manager.
• Up to 20 mailboxes can be specified as destinations.
• Messages specified as private by the message sender cannot be transferred.
• Messages transferred to other mailboxes still remain in the Subscriber's mailbox until the Subscriber erases them himself; or until the "Saved Message Retention Time" expires.

S.A. • "Saved Message Retention Time" (page 4-28)

S.M. • Listening to Messages (page 5-17)

M.M. • Listening to Messages (page 6-5)

Subscriber • Message Transfer (Subscriber's Guide page 2-6)

Message Waiting Notification – Device

Description The VPS notifies the Subscriber that there are messages recorded in his mailbox. This feature eliminates the need to regularly check the mailbox.

The VPS calls a specified telephone or beeper. If it is a telephone, the VPS plays the message. If it is a beeper, the caller's callback number can be displayed on its LCD.

3 Features and Services



Notification Device

Up to three devices (either a telephone or a beeper) can be assigned as destinations.

Each device can be on or off for a whole day. Also a notification schedule can be made for each day of the week. Up to two time frames can be set.

Here is an example of notification using a schedule.

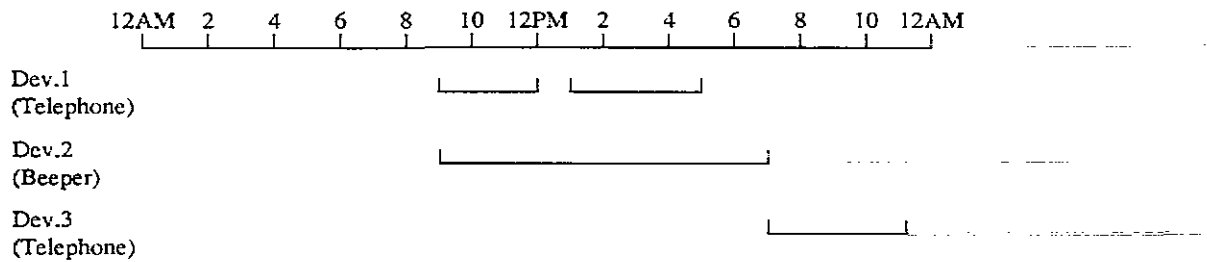

To set the schedule for Monday, the following System Programming is required:

Device 1 Parameters				
Number to Dial			
Type		Telephone		
Use Device		Scheduled		
:		:		
Schedule	Time Frame 1		Time Frame 2	
Day	Start Time	End Time	Start Time	End Time
Mon	9:00,AM	12:00,PM	1:00,PM	5:00,PM
:	:	:	:	:

Device 2 Parameters				
Number to Dial			
Type		Beeper		
Use Device		Scheduled		
:		:		
Schedule	Time Frame 1		Time Frame 2	
Day	Start Time	End Time	Start Time	End Time
Mon	9:00,AM	7:00,PM		
:	:	:		

Device 3 Parameters				
Number to Dial _____			
Type _____	Telephone			
Use Device _____	Scheduled			
⋮	⋮			
Schedule	Time Frame 1		Time Frame 2	
Day	Start Time	End Time	Start Time	End Time
Mon	7:00,PM	11:00,PM		
⋮	⋮	⋮		

When Busy or No-Answer

If the Subscriber is unable to answer a call, the VPS keeps calling in the following manner:

- a) Calls the same device as many times as specified in "Number of Retries".
- b) If the notification to the first device is unsuccessful, then the VPS changes the destination to the second one. If it is not during the notification time, the VPS skips the device and calls the third one.
- * If a message is recorded when there is no device available, the VPS extends the notification until the next available device status.
- c) The VPS calls Device 1 through Device 3 in this order.
- * The above is also true of beepers. In this case, the VPS keeps calling the beeper until the Subscriber gains access to the mailbox.

Termination

The notification is terminated, even if unplayed messages still exist in the mailbox on condition that:

- a) the Subscriber gains access to the mailbox.
- b) the attempt to the third device fails.
- c) the day changes.
- * If the message is recorded at the last moment of a day, it is likely that the day will change before the VPS starts calling. In this case, no notification will be given even if the message was recorded properly.
- * To have all the messages notified, System programming is required ("Device Notification for Unreceived Message").

More Information

- **Callback Number Entry**
When the destination is a beeper, you can receive a callback number.
- **Message Waiting Notification-Lamp**
You can set the Message Waiting Notification-Lamp at the same time. When both types of notification are activated at the same time, the VPS will turn on the lamp first and then call the devices.

3 Features and Services

M

- Conditions**
- This feature is also available to the Message Manager.
 - Class of Service programming determines which Subscriber can use this feature.
 - The Subscriber must contact the System Administrator to check the set schedule.
- S.A.**
- “Class of Service Number” (page 4-21) / “Number to Dial” (page 4-23)
 - “Type” (page 4-24) / “Use Device” (page 4-24)
 - “Number of Retries” (page 4-24) / “Busy Delay” (page 4-24)
 - “No Answer Delay” (page 4-24) / “Time frame 1, 2” (page 4-24)
 - “Authorization of Message Notification” (page 4-33)
 - “Beeper Callback No. Entry Mode” (page 4-33)
 - “Device Notification for Unreceived Message” (page 4-33)
 - “Outgoing Call Ports” (page 4-67)
- S.M.**
- “Message Notification Status” (page 5-9)
- M.M.**
- Setting Notification by Calling Status (page 6-7)
- Subscriber**
- Setting Notification by Calling (Subscriber's Guide page 5-14)

Message Waiting Notification – Lamp

Description The VPS notifies the Subscriber that there are unplayed messages waiting in the mailbox by illuminating the Message Waiting Lamp on his telephone. This feature eliminates the need to regularly check the mailbox.

- Conditions**
- This feature is also available to the Message Manager.
 - Class of Service programming determines which Subscriber can have this feature.
 - This feature is available only on telephones which has a Message Waiting Lamp.
 - If the mailbox belongs to an Extension Group, the VPS turns on the Message Waiting Lamp on all the telephones in the group (see **Extension Group**).
 - If D-PITS Voice Mail Integration is not activated, make sure that the following System Programming items of Panasonic KX-TD series telephone system are completed for this feature:

*[114] VM Command DTMF Set-GETMSG=*H*

[609] Voice Mail Access Codes-Mailbox ID code=Mailbox number

[990] System Additional Information-Field (18)=1

- Once the Subscriber gains access to the VPS to listen to the newly recorded messages, the Message Waiting Lamp turns off automatically even if some messages remain unreceived. To keep the lamp illuminated, System Programming is necessary ("Message Waiting Lamp Notification for Unreceived Messages").
- It is possible to set the Message Waiting Notification-Device feature at the same time. When both types of notification are activated, the VPS will turn on the lamp first and then call the devices.

- S.A.**
- "Class of Service Number" (page 4-21)
 - "Authorization of Message Notification" (page 4-33)
"MWL Notification for Unreceived Message" (page 4-33)
 - "Message Waiting Lamp Ports" (page 4-67)
"Message Waiting Lamp for Every Message" (page 4-67)
- S.M.**
- "Message Notification Status" (page 5-9)
- M.M.**
- Setting Message Waiting Lamp Status (page 6-7)
- Subscriber**
- Message Waiting Lamp Notification Setting
(Subscriber's Guide page 5-13)

Multi-Lingual Service

Description Callers can hear the voice prompts in one of the three languages which the VPS supports.

Prompt Options

The VPS supports three prompt options:

System prompt: English (recorded at the factory)

User 1 prompt: another language (recorded by the Message Manager)

User 2 prompt: another language (recorded by the Message Manager)

In addition, setting the prompt mode to "Selective" enables the callers to select a desired language from the three. They will hear the Selection Menu first:

Ex. Selection menu

For English, press [7].

For French, press [8].

For Chinese, press [9].

- * Callers from a rotary telephone cannot specify the language. System Programming determines the prompt mode for them.

3 Features and Services



- Conditions**
- The Message Manager records User 1 and User 2 prompts. If some prompts have not been recorded, corresponding System prompts will be played instead.
 - The Selection Menu should be recorded by the Message Manager in the appropriate language.
 - In incoming call service, the prompt mode selected in one service will be passed on to another service which the caller may enter. For example, if the caller enters the Automated Attendant service from the Voice Mail service by using the Service Access Command [#] [8], the prompts are played in the same language as in the Voice Mail service.

Prompt Mode Setting for Incoming and Outgoing Services

In incoming call services, basically the port setting is valid. In some services, however, additional settings which replace the port setting are required. Some services also do not support the Multi-Lingual service itself.

In outgoing call services, there is no port setting. Prompt mode should be specified on a COS basis.

Valid Setting		Port (Incoming Call Service Prompt)	COS Setting (Prompt Mode)	COS Authoriza- tion (Prompt For External Message Delivery)	Custom (Prompt Mode)	Remarks
Incoming Services	Voice Mail Service	System Manager	—	—	—	Only System Prompt provided.
		Message Manager	—	—	—	Only System Prompt provided.
		Non-Subscriber	✓	—	—	
		Subscriber	—	✓	—	Personal Greeting must be recorded separately.
		Automated Attendant Service	✓	—	—	
		Interview Service	—	—	—	Questions must be recorded separately.
		Custom Service	—	—	—	✓
Outgoing Services	External Message Delivery	—	—	✓	—	
	Message Waiting Notification	—	✓	—	—	

✓ = Valid setting

Available Prompt Options

		Valid Setting				
		System	User 1	User 2	Selective	
Incoming Services	Voice Mail Service	System Manager	✓	—	—	—
		Message Manager	✓	—	—	—
		Non-Subscriber	✓	✓	✓	✓
		Subscriber	✓	✓	✓	—
	Automated Attendant Service	✓	✓	✓	✓	
	Interview Service	✓	—	—	—	
	Custom Service	✓	✓	✓	✓	
Outgoing Services	External Message Delivery	✓	✓	✓	✓	
	Message Waiting Notification	✓	✓	✓	—	

✓ = an available option

- * In the Interview service, no voice prompt is played. Callers will only hear the questions recorded by the Subscriber. To utilize the Multi-Lingual service, the Subscriber must record the questions in the appropriate language.
- * In the Custom service, each Custom service menu has its own prompt mode. The menu messages should be recorded separately in the appropriate language. See below.

Ex. Menu Message

*If you wish to speak with Mr. Stephan Jones, press [1].
If with Ms. Sally Williams, press [2].*

Supporting the Multi-Lingual Service in the Custom Service

Custom 1 acts as a language selection menu where the caller selects the language he wishes to hear.

For example, to provide bilingual service in English and Spanish, record the menu message of Custom 1 in English or Spanish as follows.

3 Features and Services

M

Ex. Custom 1 Menu Message for Bilingual Service

For English, press [7].

For Spanish, press [8].

Then create the tree as below:

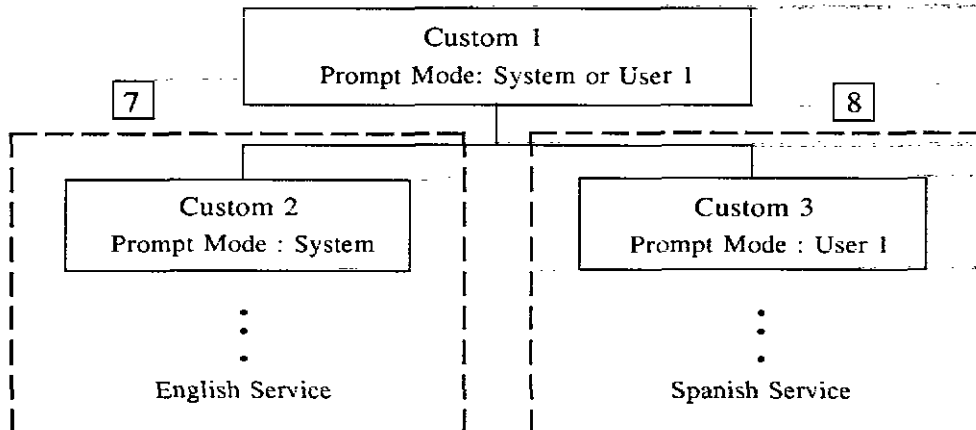

In Custom 1, set the prompt mode to “System (English)” or “User 1 (Spanish)”

In Custom 2, record the message menu in English and also set the prompt mode to “System (English)”. Create subsequent menus in this manner.

In Custom 3, record the message menu that has the same options as Custom 2 in Spanish and also set the prompt mode to “User 1 (Spanish)”. Create subsequent menus in this manner.

- S.A.**
- Class of Service Setting “Prompt Mode” (page 4-30)
 - Special Feature Authorization “Prompt Mode” (page 4-34)
 - “Incoming Call Service Prompt” (page 4-38)
 - Custom Service “Prompt Mode” (page 4-51)
 - Prompt Setting (page 4-62)
- S.M.**
- “Subscriber Service Prompt Mode” (page 5-9)
- M.M.**
- Recording Company Messages (page 6-12)
- Subscriber**
- Recording Personal Greetings (Subscriber's Guide page 5-7)
 - Recording Questions for the Interview Mailbox (Subscriber's Guide page 5-17)

No-Answer Coverage Mode

Feature Ref. Operator Service

Description Specifies how to handle a call when the Operator does not answer them within "Operator No-Answer Time".

Available options are:

1 Caller Select

The caller can choose one of the following two options.

- (a) Leave a message
- (b) Call another extension

2 Leave Message

The caller can leave a message in Operator 1's mailbox.

3 Disconnect Message

The caller is disconnected from the VPS after hearing "*Thank you for calling*".

4 Next Operator

The caller is transferred to Operator 2's extension.

The factory setting is "Caller Select".

Conditions • "Next Operator" cannot be set for the Operator 3.

S.A. • "No-answer Coverage Mode" (page 4-47)

Operator Service

Description Up to three operators can be assigned to help callers reach their desired extension. Another three operators can be assigned in the night mode.

More

Information

• **Busy Coverage Mode, No-Answer Coverage Mode**

When the line is busy or there is no answer, the call should be handled by the Busy Coverage Mode or No-Answer Coverage Mode.

■ Operator Call Coverage

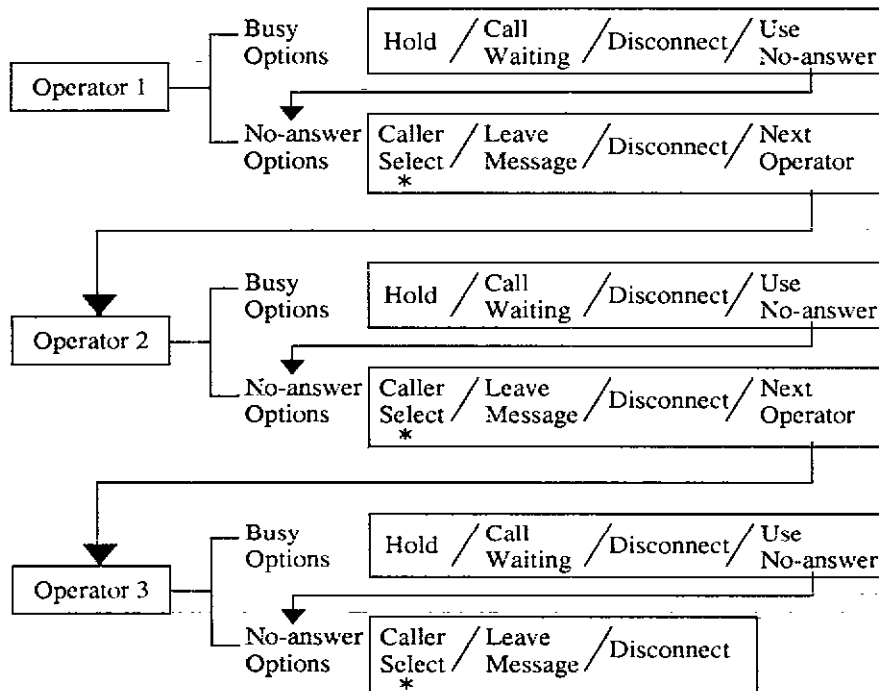

* Lets the caller choose whether to leave his message or to try another extension.

Conditions

- System Programming or the Message Manager determines the operator's extension number.
- Usually, the Message Manager is assigned as Operator 1.
- This service can be deactivated by System Programming and operator-seeking calls are transferred to the General Delivery Mailbox.

S.A.

- Operator's Parameters (page 4-41)

M.M.

- Operator's Extensions (page 6-10)

PBX Integration

Description

The VPS works well with all Panasonic KX-T series PBXs and it can be programmed to work with most other manufactures' PBXs that fully support single line telephone interfaces.

However, since both the VPS and PBX are independent systems, "Integration" with the PBX is necessary to make the two systems work more closely.

Without Integration, both systems will work separately without knowing the status of the other system.

One of the following two types of Integration is available between the VPS and PBX, if your PBX supports Integration feature.

(a) **Inband Integration**

The PBX sends the VPS several codes with DTMF tone via speech path (see **Inband**).

(b) **D-PITS Integration**

The PBX sends the VPS information over the data link (see **D-PITS**).

Conditions • System Programming determines the Integration type.

S.A. • Dialing Parameters (page 4-78)

Personal Greetings

Description The Subscriber can record personal greeting messages, if necessary, with their own voice for callers who enter the mailbox. Personal Greetings can be categorized into the following three types:

- (a) No Answer played during business hours
- (b) Busy played whenever the line is busy
- (c) After Hours played outside of business hours

The No-answer greeting is also played:

- (a) when the caller accesses the mailbox directly
- (b) when the Busy or the After Hours greeting has not been recorded.

More

Information • **Play System Prompt after Personal Greeting**
The Guidance for Recording in System Prompt can be played for the caller to instruct them how to record a message.

S.A. • "Personal Greeting Length" (page 4-28)

S.M. • "Personal Greeting Length" (page 5-7)

Subscriber • Recording Personal Greetings (Subscriber's Guide page 5-7)

3 Features and Services

P

Play System Prompt After Personal Greeting

Feature Ref. Personal Greeting

Description Specifies whether or not Guidance for Recording is played to the caller after the Personal Greeting.

Guidance for Recording is:

*To end recording, hang up or press [1] for more features.
To pause and restart recording, press [2].*

Note: The above prompt can be recorded in other languages. Refer to "Recording User Prompts" in Chapter 6.

Conditions • If a Personal Greeting is not recorded, Guidance for Recording is always played to the caller before recording.

S.A. • "Play System Prompt after Personal Greeting" (page 4-29)

S.M. • "Play System Prompt After Personal Greeting Status" (page 5-8)

Port Service

Feature Ref. Call Services

Description One of the incoming call services can be assigned to each port. Also a Company Greeting number, prompt mode and delayed answer time can be set by respective ports.

More

Information

• **Incoming Call Service**

The VPS has the following four services to answer the incoming calls.

1 Voice Mail Service

2 Automated Attendant Service

3 Interview Service

* A Subscriber's interview mailbox can be assigned to the port.

4 Custom Service

* A Custom service will be assigned to the port.

S.A. • Port Assignment (page 4-37)

Private Message

- Feature Ref.** Message Transfer
Message Delivery, Internal
- Description** Allows the Subscriber to specify the sending message as private. Once it is specified, then the receiving Subscriber cannot transfer it to other mailboxes.
- Conditions**
- Messages can be specified as private only by the Message Delivery, Internal feature.
- Subscriber**
- Message Transfer (Subscriber's Guide page 2-6)
 - Delivering Messages to Other Subscribers (Subscriber's Guide page 3-2)

Receive Message

- Description** All Subscribers, System Manager and Message Manager can listen to the messages left in their mailboxes.
- More Information**
- **Reply to Message Sender**
After listening to a message, the Subscriber can reply to the sender without specifying the extension.
 - **Message Transfer**
After listening to a message, the Subscriber can transfer it to other mailboxes.
 - **Message Scan**
Subscribers can listen to the first four seconds of each message.
- S.A.**
- "Message Retrieval Order" (page 4-28)
- S.M.**
- "Message Retrieval Order" (page 5-8)
 - Listening to Messages (page 5-17)
- M.M.**
- Listening to Messages (page 6-5)
- Subscriber**
- Receiving Messages (Subscriber's Guide page 2-2)

3 Features and Services

R

Record Message

Description Any caller who accesses the Voice Mail service can record a message in a mailbox; System Manager's mailbox, Message Manager's mailbox or Subscriber's mailbox including an Interview mailbox.

More

Information

- **Rotary Telephone Service**
For callers with a rotary telephone, the General Delivery Mailbox is provided to leave a message.
- **Two-Way Recording**
The Subscriber can record the conversation in his mailbox.

Subscriber

- Recording Messages (for any caller) (Subscriber's Guide page 4-2)
- Recording Messages (from a rotary telephone) (Subscriber's Guide page 4-3)

Reply to Message Sender

Feature Ref. Receive Message

Description

The Subscriber can reply to a message sender in two ways:

- (a) Send a message to the sender's mailbox.
- (b) Call the sender's extension.

In both cases, the Subscriber does not have to specify the sender's mailbox or extension. The date and time for reply can be also specified.

Conditions

- This feature is available to the Subscribers, the System Manager and the Message Manager.
- There are four possible situations which can utilize this feature;
 - (a) When messages are transferred or delivered via other Subscriber's mailboxes. (Message Delivery, Internal, Message Transfer)
 - (b) * When messages are left by a Subscriber who entered the VPS from his extension to access the intended mailbox.
If Direct Mailbox Access of COS is set to "No", this feature is available. If set to "Yes", the Subscriber will be directly connected to his own mailbox when entering the VPS (see **Direct Mailbox Access**).
 - (c) * When messages are left by a Subscriber who called from his extension and was forwarded to the VPS.
 - (d) When messages are delivered via the External Message Delivery service, but the recipient can only leave an immediate reply in the sender's mailbox (see **External Message Delivery Service**).

- * To use these features, your PBX must be one of the Panasonic KX-TD series telephone systems and the D-PITS Voice Mail Integration is activated.

- Subscriber**
- Replying to Messages (Subscriber's Guide page 2-5)
 - Replying to External Delivery Messages (Subscriber's Guide page 4-5)

Rotary Telephone Service

Feature Ref. Automated Attendant Service

Description The VPS will provide guidance to callers using rotary telephones. These callers are automatically directed to either the operator's extension or to the General Delivery Mailbox in Automated Attendant service.

Conditions

- This service is also available to callers who do not enter anything the first few seconds because they are unfamiliar with the VPS.
- The System Administrator needs to define guidance for daytime and nighttime respectively.
- When the operator is not available to answer a call, the call is treated by the operator's coverage mode (see **Operator Service**).
- When calls from rotary telephones enter a Custom service, they are treated according to the System Programming of Custom service.
- When calls from rotary telephones enter Voice Mail service, they can leave messages in the General Delivery Mailbox.

S.A.

- "Incoming Call Service Prompt" (page 4-38)
- Operator's Parameters (page 4-41)
- "No DTMF Input Operation" (page 4-51)
- Rotary Telephone Service (page 4-71)

M.M.

- Managing the General Delivery Mailbox (page 6-5)

Subscriber

- Recording Messages (from a rotary phone)
(Subscriber's Guide page 4-3)

Selection Menu

See **Multi-Lingual Service**.

3 Features and Services

S

Service Access Commands

- Description** Entering the following commands allows the caller to directly access the respective features.
- [0] repeat the Help menu (to call the operator for the caller)
 - [*] back up
 - [#] [1] dial by name
 - [#] [3] Department Dialing
 - [#] [5] Log in
 - [#] [6] Voice Mail service
 - [#] [7] restart (Subscriber's main command)
 - [#] [8] call transfer
 - [#] [9] exit the menu
- Conditions** • They cannot be used in cases where functions have been assigned to each number, or when [#] is necessary to enter the specified parameters such as date or time.
- Subscriber** • Accessing VPS Services (Subscriber's Guide page 1-3)

Special Feature Authorization

- Description** Determines whether or not to allow the Subscriber to use the following special features.
- Message Waiting Notification
 - External Message Delivery
 - Auto Forwarding
- Conditions** • All of the features are deactivated when a new mailbox is created.
- S.A.** • Special Feature Authorization (page 4-32)
- S.M.** • Setting COS (Class of Service) Parameters (page 5-7)

System Clock

Description When a new VPS is installed, it is necessary to set the date and time. It is important to set the exact time as some of the essential features of the VPS such as the Message Waiting Notification, External Message Delivery, Automatic Message Deletion are scheduled according to this setting.

More

Information

- **Daylight Savings Time**

The system automatically adjusts the time as appropriate when daylight savings time begins and when it ends.

Conditions

- The System Administrator, System Manager or Message Manager can set the clock. (Only one at the time can access the feature.)

S.A.

- Set Time (TIME) (page 7-4)

S.M.

- Setting the System Clock (page 5-11)

M.M.

- Setting the System Clock (page 6-11)

System Reports

Description The System Administrator can provide eight types of system reports to help monitor the VPS operating status. The reports can be sent out via the RS-232C port to a printer or a terminal. The following eight report options are available:

Mailbox Assignments

This report provides information about authorized features for each mailbox, and current settings for mailbox parameters.

COS (Class of Service) Assignments

This report provides all information on the Class of Service.

System Service Report

This report provides information about the usable ports of the VPS. It also indicates the services assigned to each VPS port for Day, Night and Holiday modes, and the incoming and outgoing call services.

Call Account Report

The VPS can maintain information on up to 80 outgoing call sequences for the call account.

3 Features and Services

ST

Port Usage Report

This report provides information about port usage and allows you to measure traffic on the system and ports.

Disk Usage Report

This report indicates the amount of disk storage in use and availability in minutes.

Mailbox Usage Report

This report provides information about the usage of a specific mailbox.

Fax Call Report

This report provides information about the fax transfer status when the VPS receives a fax signal.

- S.A.** • System Reports (page 7-15)
- S.M.** • Obtaining System Reports (page 5-12)

Two-Way Recording (D-PITS Only)

Feature Ref. Record Message

Description The Subscriber can record a conversation in his own mailbox or other Subscribers' mailboxes while talking on the phone. A beep sounds every sixteen seconds during recording.

Conditions • This feature is available only if D-PITS Voice Mail Integration with a Panasonic KX-TD series telephone system is activated, which provides a feature button for Two-Way Recording.

 • When the Subscriber records his Two-Way telephone conversation, he should inform the other party that the conversation is being recorded.

 • To record a conversation, press the feature button of the Proprietary Telephone of the PBX. To record the conversation in another Subscriber's mailbox, enter its mailbox number besides the feature button.

S.A. • "PBX Type" (page 4-79) / "Integration Mode" (page 4-81)

Subscriber • Recording a Two-Way Conversation (Subscriber's Guide page 2-10)

Utility Commands

Description Allows the System Administrator to access the functions described below by entering the appropriate command at the \$ prompt.

OFLN..... Sets the System to off-line mode (OFF)
 ONLN..... Sets the System to on-line mode (ON)
 PASS Sets the System Administrator's password and System Reset/
 Clear password
 TIME. Sets the system clock (date and time)
 PSET..... Specifies the reports printing time
 ELOG Displays device error log
 SAVE..... Stores a backup of the program or data on the hard disk
 LOAD..... Restores a backup of the program or data to the system
 GPRN Displays all of the VPS parameters
 VERS Displays the version of the hard disk, main ROM and Port
 card
 CREP Displays current settings of a Custom service menu
 CCLR..... Clears the access count of a Custom service menu
 MWL Sets the retry count of Message Waiting Lamp
 MRL Sets the minimum recording length of a message
 MPLT Displays the user prompt recording status
 HELP Lists utility command names
 QSET Sets up the VPS so you can use it quickly

S.A. • Utility Commands (page 7-2)

Voice Mail Service

Description This service is a message taking service, which allows the Non-Subscriber to leave a message in the mailbox of the Subscriber, System Manager or Message Manager.

In addition, the mailbox owner (Subscriber, System Manager and Message Manager) performs a variety of special services by accessing the mailbox.

Subscriber Service

Supports a variety of voice messaging services unique to the Subscriber by accessing his own mailbox.

The Subscriber can listen to the recorded messages or deliver messages to the Subscriber or Non-Subscriber.

In addition, various settings required for receiving calls and messages effectively can be performed.

3 Features and Services



- Receiving Messages
- Delivering Messages to Mailboxes
- Setting Message Waiting Notification
- Setting External Message Delivery
- Setting the Automated Attendant Status
- Interview Mailbox Management
- Setting Password
- Recording Personal Greeting

System Manager Service

The System Manager takes care of coordinating the VPS to ensure that it operates efficiently and effectively.

He performs a whole range of functions by using any touch-tone telephone. These include daily maintenance, the creation and editing of mailboxes in response to requests from Subscribers, and the deletion of unneeded mailboxes to prevent the system's storage capacity from overloading.

- Creating Subscriber's Mailboxes
- Setting the Class of Service
- Delivering Broadcasting Messages
- Obtaining the System Reports
- Setting the System Clock
- Receiving Messages
- Delivering Messages to Mailboxes
- Setting Password

Message Manager Service

Supports a variety of message recording services unique to the Message Manager by accessing the Message Manager's mailbox.

The Message Manager takes care of the General Delivery Mailbox, recording Company Greetings, and voice prompts by accessing the Message Manager's mailbox.

- Recording Company Greetings and Voice Prompts
- General Delivery Mailbox Management
- Setting the System Clock
- Receiving Messages
- Setting Password
- Setting Message Waiting Notification

How to Access the Automated Attendant Service

1. Voice Mail Port

This service can be assigned independently to VPS ports as an incoming call service (see **Port Assignment**). This means that dialing an extension or telephone number of this port allows the caller to directly access this service.

2. Service Access Command

Dial [#] [6] during a call. The caller then can access Voice Mail service regardless of the current accessing service (see **Service Access Command**).

3. Custom Service

This service can be assigned to the keypad as the call transfer destination.

More**Information**• **Direct Mailbox Access**

The Subscriber can access his own mailbox by simply calling the extension number assigned to Voice Mail service.

Voice Prompts

Description The VPS tells callers in a voice prompt what they should do next.

Ex. Voice Prompt

Please enter your party's extension.

To enter by name, press [#] and [1].

Prompt Options

System prompt	recorded in English at the factory
User 1 prompt	to be recorded by the Message Manager
User 2 prompt	to be recorded by the Message Manager

By recording User 1 or User 2 prompt in other languages, Multi-Lingual service is available in the VPS.

These user prompts can also be used when you want to modify some phrases in the System prompt.

Recording User 1 and User 2 Prompts

The Message Manager records User 1 and User 2 prompts via telephone. If some prompts are not recorded, the system prompts are played instead.

Linked Prompt

Some prompts link together and are played as if they were one prompt. For example, the following announcement consists of two prompts:

(prompt 315) Good morning.

(prompt 316) Welcome to the Voice Processing System.

3 Features and Services

V

Turning off a Prompt

Note the word order of your language. Direct translation may sometimes cause errors. In the following prompt, (date), (time) and (mailbox number) are always played at the end.

*(Prompt 538) Message recorded on (date)
(prompt 248) at (time)
(prompt 249) for (mailbox number)
(prompt 418) has not been received.*

Turn unnecessary prompts off. If “at (248)” and “for (249)” in the above are turned off, the caller will hear:

*(Prompt 538) Message recorded on (date)
(prompt 248) (time)
(prompt 249) (mailbox number)
(prompt 418) has not been received.*

Chapter 6 lists the table of the linked prompts with other modifiable prompts.

- Conditions**
 - Only the System prompt (English) is available to the System Manager and the Message Manager (see **Multi-Lingual Service**).
- S.A.**
 - Class of Service Setting “Prompt Mode” (page 4-30)
 - “Incoming Call Service Prompt” (page 4-38)
 - Custom Service “Prompt Mode” (page 4-51)
 - Modified Prompt List (MPLT) (page 7-13)
- S.M.**
 - “Subscriber Service Prompt Mode” (page 5-9)
- M.M.**
 - Recording Company Messages (page 6-12)

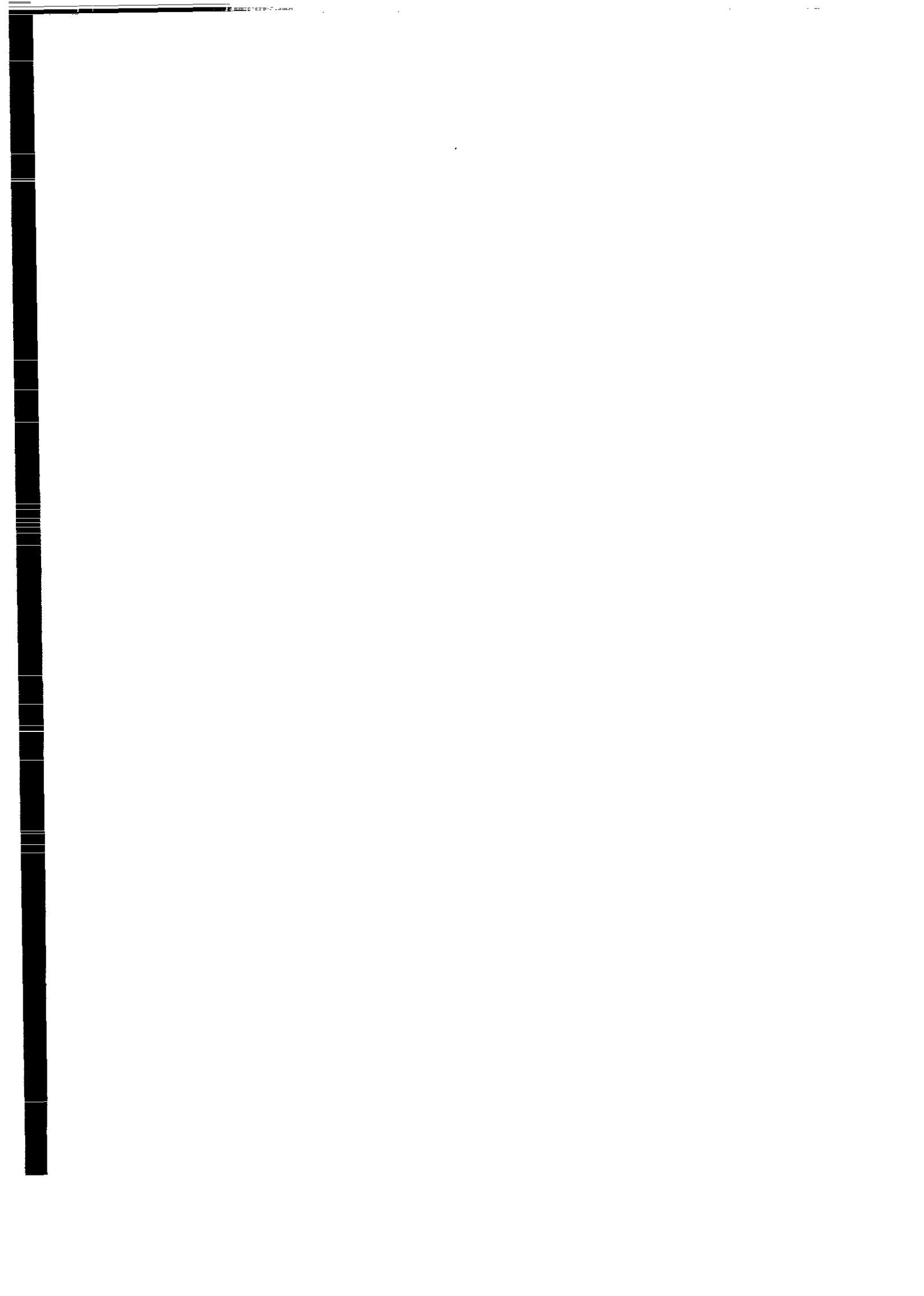

Chapter 4

System Administrator's Guide

This chapter explains the System Administrator's function and provides step-by-step instructions for system setup tasks such as setting up mailboxes, setting system parameters and running reports.

Contents

4.1 System Administrator's Function	4-2
4.2 Using the Interface	4-4
4.2.1 Keyboard Operation	4-4
4.2.2 Programming Guidance	4-5
4.3 Startup System	4-6
4.3.1 Quick Setup	4-8
4.4 Programming Menu Structure Diagram	4-16
4.5 Programming the System Parameters	4-18
4.5.1 Setting up Mailboxes	4-19
4.5.1.1 Creating and Editing Mailboxes	4-19
4.5.1.2 Deleting a Mailbox	4-25
4.5.1.3 Resetting a Mailbox Password	4-25
4.5.1.4 Listing Mailboxes	4-26
4.5.2 Setting COS (Class of Service) Parameters ..	4-27
4.5.2.1 Class of Service Setting	4-27
4.5.2.2 Special Feature Authorization	4-32
4.5.3 Port Service	4-37
4.5.3.1 Port Assignment	4-37
4.5.4 Service Settings	4-40
4.5.4.1 Automated Attendant Parameters	4-40
4.5.4.2 Custom Service	4-50
4.5.5 System Parameter Settings	4-53
4.5.5.1 System Group Assignment	4-53
4.5.5.2 Day Service	4-57
4.5.5.3 Holiday Setting	4-58
4.5.5.4 Daylight Saving Time	4-61
4.5.5.5 Prompt Setting	4-62
4.5.5.6 Other Parameters	4-63
4.5.6 Hardware Settings	4-76
4.5.6.1 RS-232C Parameters	4-76
4.5.6.2 Port Setting	4-77
4.5.6.3 PBX Interface Parameters	4-78

4.1 System Administrator's Function

As System Administrator of the VPS, you primarily take care of the operational characteristics of the entire system. You can set up system parameters, administrate the parameters, or diagnose the system using an interactive screen-based program.

System administration can be done by selecting one of the following options from the System Administration Top Menu screen below.

System Administration Top Menu

System Administration Top Menu
1. Program
2. System Reports
3. Utility Command
4. System Reset / Clear
5. Quick Setup
SELECT ITEM AND PRESS RETURN-KEY

- Notes:**
- "5. Quick Setup" in the above screen does not appear in the ASCII TERMINAL mode.
 - You may exit and return to the previous screen by pressing [N].
 - In this Chapter 4, if you want to clear the programming value of any parameter, press the Back Space key. (Some settings cannot be cleared as pertaining to the specification.)

1. Program

If you need to program the system parameters, see **Programming the System Parameters** in this Chapter.

2. System Reports

If you need to monitor the VPS operation status, see **System Reports** in Chapter 7.

3. Utility Command

If you need to turn on/off the call progressing mode of the VPS, or to make a backup copy of system data, see **Utility Commands** in Chapter 7.

4.1 System Administrator's Function

4. System Reset/Clear

If you need to reprogram the system, see **Initializing the System** in Chapter 7.

5. Quick Setup

If you are programming the system for the first time, we recommend you to employ the Quick Setup first.

It provides you a quick way of mailbox creation, incoming call service assignment for all ports, time setting and so on. See page 4-8.

Especially, if you have a Panasonic KX-TD series telephone system with D-PITS Voice Mail Integration, the Quick Setup will be completed at the same time you start up the system (see page 4-6). Make sure the following conditions are satisfied:

- The rotary switch is set to '2' or '3' before turning on the power switch of the system. See page 2-4.
- The VPS is connected to extension port of your PBX. See page 2-12. The port has to be assigned as Voice Mail port beforehand.

When prompted by instructions on the programming screen, set the rotary switch to '0'.

4.2 Using the Interface

4.2.1 Keyboard Operation

System Administration can be done using the VT100 or Compatible Terminals, or other RS-232C Terminals (ASCII Terminals).

Screen display and keyboard operation may differ depending on the data terminal you use.

● VT100 or Compatible Terminals

You can choose an option either by:

- moving the cursor to the desired option, then press [RETURN].
- or
- entering the corresponding key number directly, then press [RETURN].

Key	Functions
↑	Moves the cursor to the previous line
↓	Moves the cursor to the next line
→	Moves the cursor to the right
←	Moves the cursor to the left
[1] -- [9]	Directly moves the cursor to the specified number
[RETURN]	Selects reversed item
[N]	Exits the current screen and returns to the previous step in the menu

● Other RS-232C Terminals (ASCII Terminals)

You can choose an option by entering the corresponding key number directly, then press [RETURN].

Key	Functions
[1] -- [9], then [RETURN]	Selects item from the menu on the screen
[N]	Exits the current screen and returns to the previous step in the menu

4.2 Using the Interface

4.2.2 Programming Guidance

On top of each screen display in this manual, you will find a programming guidance indicated by the arrow in the example below. This helps you locate the desired programming screen quickly.

(Example)



System Administration Top Menu → 1 → 3 → 1 → 1

Program – Port Service – Port1 – Day Mode Menu

Company Greeting No. (1-32)	: 1
Incoming Call Service	: Auto. Attn.
Incoming Call Service Prompt	: User 1
Delayed Answer Time (0-15 sec)	: 0

System Administration Top Menu → 1 → 3 → 1 → 1 means the following steps:

1. Press [1] in the System Administration Top Menu.

You will see the next menu.

2. Press [3] and [RETURN].

You will see the next menu.

3. Press [1] and [RETURN].

You will see the next menu.

4. Press [1] and [RETURN].

“Port 1 – Day Mode Menu” will be displayed on the terminal.

4.3 Startup System

To start the VPS operation, system installation and line connections must be done beforehand. See Chapter 2.

Status of the Power Indicator



- 1 Turn on the POWER switch of the VPS.



- 2 System Setup is started and the display shows:

```
CARD TEST . . .  
SYSTEM SETUP . . .  
1. . . 2. . . 3. . .
```



- 3 When System Setup is completed successfully, the display shows:

(In D-PITS Integration mode)

```
Active COs : 1 2 3 4  
DPITS Interface Connection is Established  
** ON LINE MODE **  
>
```

(In non-D-PITS Integration mode)

```
Active COs : 1 2 3 4  
** ON LINE MODE **  
>
```

If System Setup is not completed successfully

(In D-PITS Integration mode)



```
Active COs : 1 2 3 4  
DPITS Interface Connection is not Established  
** OFF LINE MODE **  
>
```

Note: "Active COs" in the above screens means "Active Ports".

4.3 Startup System

Note: This message is shown on the terminal when D-PITS communication between the VPS and a Panasonic KX-TD series telephone system is not made. In this case, turn off the VPS and start it again after confirming the line connections and the required programming.

(In non-D-PITS Integration mode)

```
** OFF LINE MODE **  
>
```

4 Press [RETURN].

```
Please Select Your Terminal Type.  
1. ASCII TERMINAL  
2. VT100  
Please Enter the Number :=
```

5 Press [1] or [2] to specify the RS-232C terminal type.

System Administration Top Menu

```
1 : Program  
2 : System Reports  
3 : Utility Command  
4 : System Reset/Clear  
5 : Quick Setup  
SELECT ITEM AND PRESS RETURN-KEY
```

Note: "5: Quick Setup" in the above screen does not appear in the ASCII TERMINAL mode.

4.3.1 Quick Setup

Quick Setup provides a quick way of system setup. You must initially set the following programming items to start the VPS operation.

1. PBX Type
2. Extension numbers of VPS ports
3. Extension numbers for mailboxes
4. Creating Mailboxes
5. Port Service Setting
6. Password Setting
7. Date and Time Setting
8. Activating the Quick Setup

Depending on your PBX type, some steps can be skipped as shown below.

PBX Type	Required Procedures
KX-T308/T616	1→2→3→4→5→6→7
KX-T1232/T96/T336, non-Panasonic system	1→3→4→5→6→7
KX-TD816/1232	1→4→5→6→7

Starting the Quick Setup

At the System Administration Top Menu, type "5" and press [RETURN]. (Only available in the VT100 mode)

System Administration Top Menu → 5

Quick Setup Utility for connection to Panasonic KX-T series telephone systems

This utility provides a quick way of programming the Voice Processing System to operate in a standard automated attendant or voice mail configuration when connected to a Panasonic KX-T series telephone system. The system will prompt you to enter, modify or confirm settings based upon which PBX type you select.

By entering the appropriate information in the following screens, the system sets PBX integration parameters, identifies the extension numbers connected to it, creates default mailboxes, sets its ports to handle callers with automated attendant or voice mail service, sets system passwords and sets the time and date. Finally, it confirms that you want to activate the system based on the information you entered, modified or confirmed.

To proceed, press Enter. To exit and cancel Quick Setup now, press \.

Note: Utility Command "QSET" is also available for starting the Quick Setup. See page 7-14.

4.3.1 Quick Setup

Step 1. PBX type

After pressing [RETURN] (Enter), the screen shows:

Quick Setup – PBX type

Please select your PBX type.

1. KX-T308
2. KX-T616
3. KX-T1232
4. KX-T96
5. KX-T336
6. KX-TD816
7. KX-TD1232
8. OTHERS

Select your PBX type, and you may go to Step 2, 3 or 4 depending on your selection as shown below.

- | | | | | |
|-------------|--------------|---------------|-----------|---------------|
| 1. KX-T308 | 2. KX-T616 | Go to Step 2. | | |
| 3. KX-T1232 | 4. KX-T96 | 5. KX-T336 | 8. Others | Go to Step 3. |
| 6. KX-TD816 | 7. KX-TD1232 | Go to Step 4. | | |

Note: D-PITS Voice Mail Integration will be activated automatically by selecting “6. KX-TD816” or “7. KX-TD1232”. However, if D-PITS Voice Mail Integration is not supported with your KX-TD series telephone system, you have to program the integration mode to “None” or “Inband” before the Quick Setup (see page 4-81). After selecting your PBX type here, you will go to Step 3.

Step 2. Extension numbers of VPS ports

Quick Setup – Enter extension number of VPS Port

Please enter extension number of VPS.

1: 11	2: 22	3: 33
4:	5:	6:

Please enter extension numbers.
(2 digits) : =

S: Next Screen

4.3.1 Quick Setup

Enter extension numbers of VPS ports with 2-digit numeric characters.

By this programming, the VPS performance with the KX-T308 or KX-T616 is improved as the VPS can discriminate between VPS extensions and non-VPS extensions.

Type "S" to go to the next screen.

Step 3. Extension numbers for mailboxes

Quick Setup – Enter Extensions for Mailboxes

What extension needs a mailbox on this system?

1: 110	2: 111	3: 112	4: 113	5: 114
6: 115	7: 116	8: 117	9: 118	10: 119
11: 120	12: 121	13: 122	14: 123	15: 124
16: 125	17: 126	18: 127	19: 128	20: 129
21: 130	22: 131	23: 132	24: 133	25: 134
26: 135	27: 136	28: 137	29: 138	30: 139
31: 140	32: 141	33: 142	34: 143	35: 144
36: 145	37: 146	38: 147	39: 148	40: 149
41: 150	42: 151	43: 152	44: 153	45: 154
46: 155	47: 156	48: 157	49: 158	50: 159
51: 160	52: 161	53: 162	54: 163	55: 164
56: 165	57: 166	58: 167	59: 168	60: 169
61: 170	62: 171			

Please enter extension numbers.

: =

S: Next Screen

Enter extension numbers of persons who need a personal mailbox (Subscriber mailbox) with 2 to 5 digits. For example, to enter the extension number 101, enter "101" and press [RETURN]. Also you can enter the extensions from No. 101 to No. 110 by entering "101-110" and [RETURN].

The VPS will create the mailboxes which have the same numbers as the extension numbers (see Step 4).

- Notes:**
- The VPS accepts extension numbers with different lengths within 2 to 5-digit range.
 - Up to 62 extension numbers can be entered.

4.3.1 Quick Setup

Step 4. Creating mailboxes

Quick Setup – Mailbox Editing				
Extension and mailbox list		Assigned 62	Vacant 0	Page 1/4
Extn.	MBX	OWNER (Last Name)	MAKE (Make/Delete)	
...	: 101	Make	
110	: 110	Make	
111	: 111	Make	
112	: 112	Make	
113	: 113	Make	
114	: 114	Make	
115	: 115	Make	
116	: 116	Make	
117	: 117	Make	
:	:	:	:	

P: Previous menu, N: Next menu, S: Next Screen

1. To create or discard the mailboxes

In the “MAKE (Make/Delete)” field, type “M (Make)” to create the mailbox or type “D (Delete)” to discard the mailbox. If there are more than 62 mailboxes, the first 62 of them are displayed with “Make” and the rest of them are displayed with “Delete”. The screen shows “Assigned 62, Vacant 0”.

If you want to change the status of a mailbox from “Delete” to “Make”, first change the status of a mailbox from “Make” to “Delete”. The screen shows “Assigned 61, Vacant 1”.

Then you can change the status of a mailbox from “Delete” to “Make”.

2. Owner’s last name

Up to 16 alphabetic characters can be assigned as an owner’s last name.

Notes: • Mailbox numbers displayed on this screen

Panasonic KX-TD Series Telephone System with D-PITS Voice Mail Integration

The same numbers as the extension numbers of your KX-TD series telephone system which are automatically transmitted to the VPS — Auto Configuration.

4.3.1 Quick Setup

Other Telephone System

The same numbers as the extension numbers entered in Step 3.

- **The length of mailbox numbers**

If both 3-digit and 4-digit extension numbers exist at a time, the VPS will unify all mailbox numbers to 4-digit length by putting "0" at the end of all 3-digit numbers.

(Example)

Extension Numbers	Mailbox Numbers
201	201(0) *
202	202(0) *
203	203(0) *
2000	2000
2001	2001
2002	2002

* The VPS puts (0) at the end of 3-digit numbers.

If you need to program the mailbox parameters other than the extension number and owner's last name, see **Creating and Editing Mailboxes** on page 4-19.

Step 5. Port service setting

Quick Setup – Port Service Setting

All ports are currently setup to handle callers with standard automated attendant operation, day and night mode, using the Custom Service feature (Custom 1). You can change the operation to standard voice mail (Custom 2) or leave it as automated attendant. If necessary, Custom 1 and Custom 2 can be modified under the menu 'Program -> Service Setting -> Custom Service'.

PORT 1 (Day)	Auto. Attend. (using Custom 1)
PORT 1 (Night)	Auto. Attend. (using Custom 1)
PORT 2 (Day)	Auto. Attend. (using Custom 1)
PORT 2 (Night)	Auto. Attend. (using Custom 1)
PORT 3 (Day)	Auto. Attend. (using Custom 1)
PORT 3 (Night)	Auto. Attend. (using Custom 1)
PORT 4 (Day)	Auto. Attend. (using Custom 1)
PORT 4 (Night)	Auto. Attend. (using Custom 1)

A: Auto. Attend. V: Voice Mail S: Next Screen

4.3.1 Quick Setup

Incoming call services for all ports (Day/Night) can be defined for each port by this settings on the screen.

"PORT 1 (Day) ---- : Auto. Attend. (using Custom 1)" indicates that incoming call service for Port 1 (Day) is set to Custom 1 and callers to this port will receive Automated Attendant service.

You can change "Auto. Attend." to "Voice Mail". In this case, Custom service No. will be changed from '1' to '2' automatically.

The default values of the ports depend on the position of the rotary switch you used when starting up the system (see page 4-6):

Position 0 or 2 ---- Auto. Attend. (using Custom 1)

Position 3 ----- Voice Mail (using Custom 2)

If you want to select other incoming call services, see **Port Assignment** on page 4-37.

Step 6. Password setting

Quick Setup – Password Setting
System Administrator Password (Maximum 8 characters)
NEW PASSWORD : =
VERIFICATION : =
System Reset/Clear Password (Maximum 8 characters)
NEW PASSWORD : =
VERIFICATION : =

You can assign the System Administrator password and System Reset/Clear password in this screen, if necessary.

You can go to the next screen without assigning the password by pressing [RETURN].

4.3.1 Quick Setup

Step 7. Date and time setting

Quick Setup – Time Setting
Current time is 3:04, PM
Enter new time (HH:MM, AM/PM) : =
Current date is SAT JAN-1-1994
Enter new date (DD-MM-YY) : =

Enter the current day, month and year.

Note: **If you have a Panasonic KX-TD series telephone system with D-PITS Integration**
Date and Time are synchronized between the PBX and the VPS automatically.

You can go to the next screen by pressing [RETURN].

Step 8. Activating the Quick Setup

Quick Setup – Setup
To set up the mailbox and restart, select "Yes".
To cancel and exit, select "No".
1: Yes 2: No

To activate the Quick Setup, press "1".
To cancel the Quick Setup, press "2".

4.3.1 Quick Setup

The VPS begins to change system programming data.

```
Quick Setup - Setup

To set up the mailbox and restart, select "Yes".

To cancel and exit, select "No".

1: Yes      2: No

Setup 101
```

Then "CARD TEST ...", "SYSTEM SETUP ..." and "1 ... 2 ... 3 ..." appears on the screen one by one as shown below.

```
CARD TEST ...

SYSTEM SETUP ...

1 ... 2 ... 3 ...
```

When the Quick Setup is finished, the screen shows:

```
** ON LINE MODE **

>
```

Press [RETURN].

```
Please Select Your Terminal Type.

1. ASCII TERMINAL
2. VT100

Please Enter the Number :=
```

4.4 Programming Menu Structure Diagram

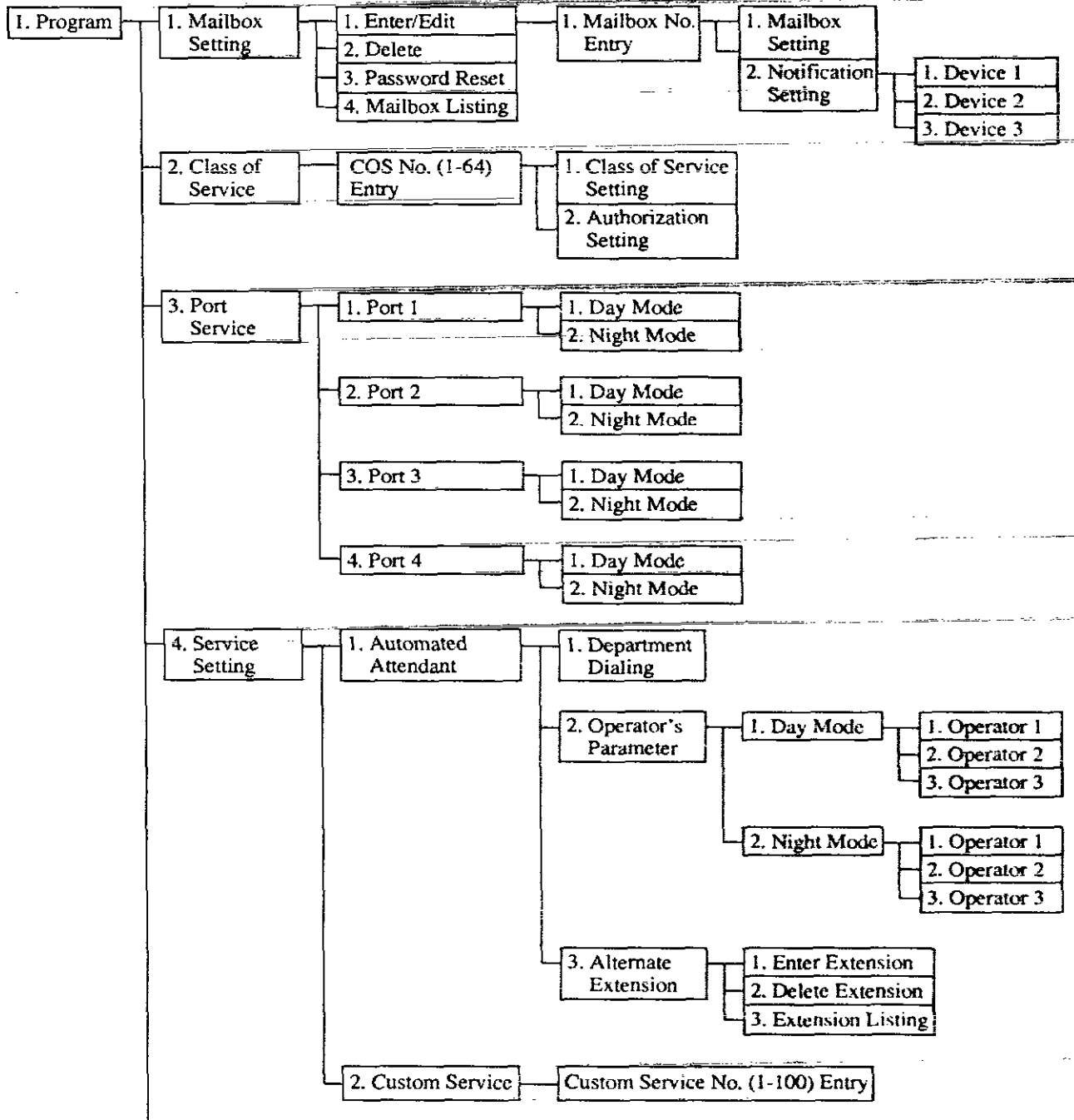

4.4 Programming Menu Structure Diagram

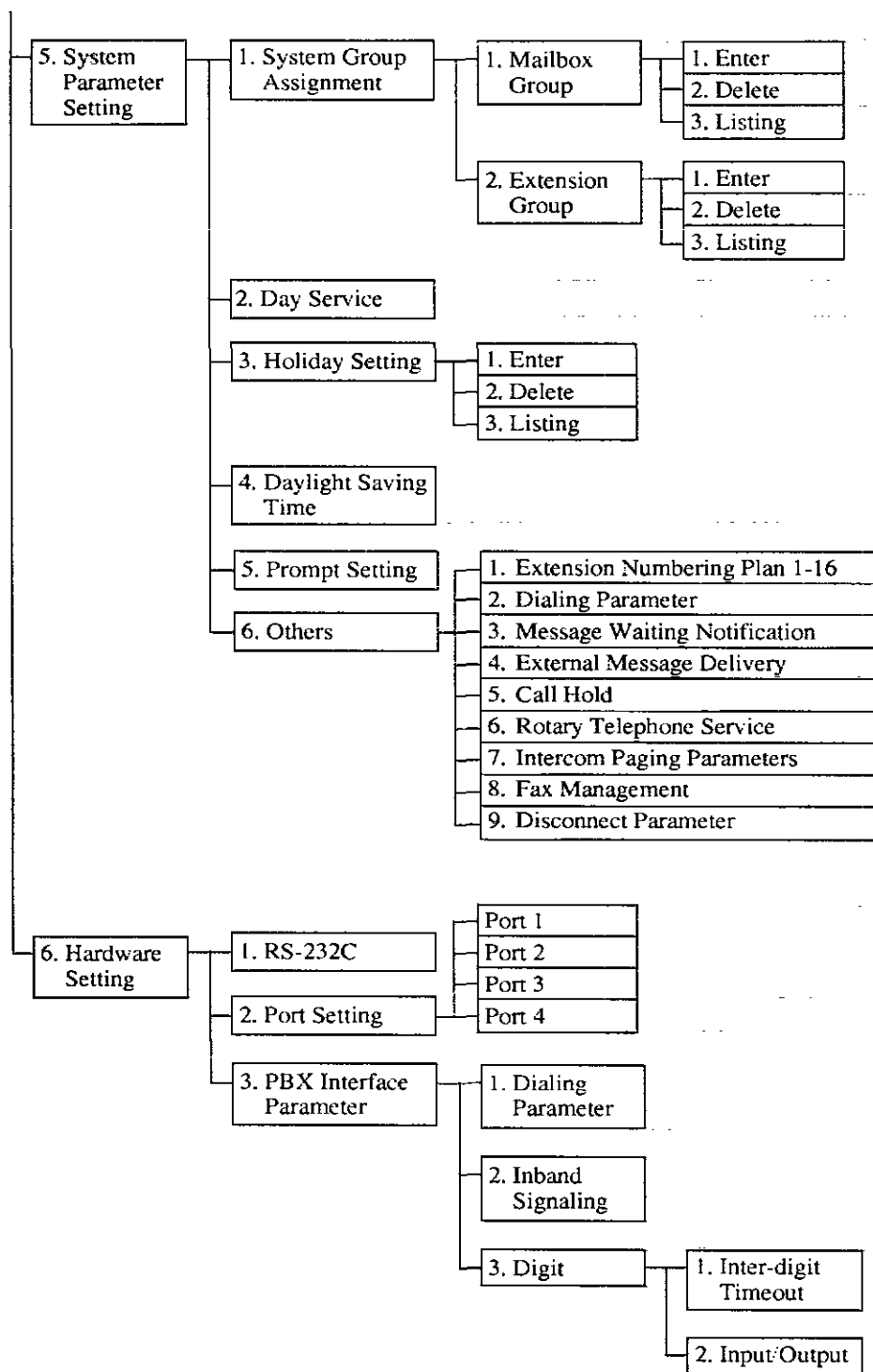

4.5 Programming the System Parameters

For the most effective utilization of the storage capacity and ports of the system, you can set up system parameters via the RS-232C port.

Note: In this chapter, parameters displayed on the screen show default values with VT100 or compatible terminals.

System Administration Top Menu → 1

<p>Program Menu</p> <ol style="list-style-type: none">1. Mailbox Setting2. Class of Service3. Port Service4. Service Setting5. System Parameter Setting6. Hardware Settings <p><u>SELECT ITEM AND PRESS RETURN-KEY</u></p>

Before starting the system parameters setup

Use the Worksheets provided to record the information you will need to set up system parameters. Just fill in the blanks with the information requested. Once you have finished filling out the worksheets, you can use them as quick reference cards to aid you in setting parameters while programming.

4.5.1 Setting up Mailboxes

You must coordinate the operation of the mailbox. You can create/delete mailboxes, reset the passwords of the Subscribers' mailboxes, install extension numbers, name of owners and the Class of Service numbers.

The System Manager can also carry out these operations by telephone at the request of Subscribers. See Chapter 5.

System Administration Top Menu → 1 → 1

Program – Mailbox Setting Menu
1. Enter/Edit
2. Delete
3. Password Reset
4. Mailbox Listing
SELECT ITEM AND PRESS RETURN-KEY

4.5.1.1 Creating and Editing Mailboxes

You can create up to 62 Subscriber mailboxes or edit existing ones by entering a mailbox number.

System Administration Top Menu → 1 → 1 → 1

Program – Mailbox Setting – Enter
1. Enter/Edit
2. Delete
3. Password Reset
4. Mailbox Listing
Enter the Mailbox Number : = *
SELECT ITEM AND PRESS RETURN-KEY

Note: **Quick Setup**
If you have already done the Quick Setup, mailboxes are already created (see page 4-8).

4.5.1 Setting up Mailboxes

Parameter	Value Range (default)	Description/Function	Reference
Mailbox Number	2-5 digits (None)	Specifies the mailbox number for Subscribers. The mailbox number length is defined by the Quick Setup (see Step 4) or Initializing the System in Chapter 7. Mailbox numbers cannot begin with zero. Therefore, if the mailbox number length has been defined as three digits, the valid range of mailbox number is 100 through 997 (998 and 999 are reserved for the Message Manager and the System Manager). Once a mailbox number length has been defined, it cannot be changed in Mailbox Setting screen.	Creating mailboxes p.4-11 Initializing the System p.7-23

System Administration Top Menu → 1 → 1 → 1 → Mailbox No.

Program – Mailbox Setting – Enter Menu

1. Mailbox Setting
2. Notification Setting

SELECT ITEM AND PRESS RETURN-KEY

Editing Mailboxes

You can edit the parameters of each mailbox based on the needs of the Subscriber.

System Administration Top Menu → 1 → 1 → 1 → Mailbox No. → 1

Program – Mailbox Setting – Enter

MAILBOX No. [XXX]

The Extension of the Owner _____ : _____
 The Spelling of the Owner First Name _____ : _____
 Last Name _____ : _____
 Mailbox Class of Service No. (1-62) _____ : 1
 Covering Extension _____ : _____
 Interview Mailbox _____ : _____
 All Calls Transfer to Mailbox _____ : No

4.5.1 Setting up Mailboxes

Parameter		Value Range (default)	Description/Function	Reference
The Extension of the Owner		2-5 digits (None)	Used to transfer calls from the system to a Subscriber's mailbox. Any valid extension number including an extension group list number can be assigned. [Note] If an extension group list number is assigned, all group members can share the same information in that mailbox.	Extension Group p.4-55
Owner Name	First	Up to 16 alphabetic characters (None)	Both first and last names are printed on the Mailbox Assignments report.	Dialing by Name p.3-20 Mailbox Assignments p.7-15
	Last		The Dialing by Name feature uses the last name.	
Class of Service Number		COS No.1-62 (1)	Used to define a set of services available to the Subscriber. [Notes] • Before assigning a Class of Service (COS) number, parameters for each COS number should be defined. • COS No. 63 is fixed to the Message Manager and No. 64 is fixed to the System Manager. These numbers cannot be assigned in this field.	Class of Service p.3-12 Setting COS Parameters p.4-27
Covering Extension		2-5 digits (None)	Specifies the extension to which the caller, who was unable to reach the Subscriber's extension via Automated Attendant service, will be transferred by caller's choice. Covering Extension is one of Incomplete Call Handling service options which can be activated or deactivated using telephone by the Subscriber. [Notes] • An extension group list number and Logical Extension number cannot be assigned as a Covering Extension. • The Subscriber can also specify the Covering Extension number using telephone.	Covering Extension p.3-13 Incomplete Call Handling Service p.3-29 Extension Group p.4-55
Interview Mailbox No.		2-5 digits (None)	Used to permit the mailbox owner to have his own interview mailbox by assigning any vacant mailbox number.	Interview Service p.3-31 Mailbox p.3-33

4.5.1 Setting up Mailboxes

Parameter	Value Range (default)	Description/Function	Reference
All Calls Transfer to Mailbox	1. Yes 2. No (No)	If set to "Yes", all calls (via the Automated Attendant) coming to the extension of this mailbox owner are automatically forwarded to this mailbox without ringing the extension, and callers can leave a message in it. [Note] When this feature is activated, the extension of this mailbox owner does not necessarily exist as a phone extension of your PBX.	Logical Extension p.3-33

Notification Setting

You can set parameters for the Message Waiting Notification - Device feature. Up to three different destinations (Device 1, 2, 3) per mailbox can be specified.

- Notes:
- Class of Service programming determines whether or not the Subscriber can utilize this feature.
 - For managers, only the Message Manager (COS No. 63) need to program Notification Setting parameters.

System Administration Top Menu → 1 → 1 → 1 → Mailbox No. → 2

Program - Mailbox Setting - Enter

1. Mailbox Setting
2. Notification Setting

Enter the Notification Device Number (1-3) : = *

SELECT ITEM AND PRESS RETURN-KEY

4.5.1 Setting up Mailboxes

Device 1

System Administration Top Menu → 1 → 1 → 1 → Mailbox No. → 2 → Device No. (1-3)

Program - Mailbox Setting - Notification Setting Menu

Device 1 Parameters

Number to Dial : 901234567

Type : Telephone

Use Device : Scheduled

Number of Retries (0-4 times) : 0

Busy Delay (2-120 min.) : 3

No Answer Delay (2-120 min.) : 30

Schedule	Time frame 1		Time frame 2	
Day	Start Time	End Time	Start Time	End Time
MON :	8:00, AM	11:00, AM	1:00, PM	5:00, PM
TUE :	8:00, AM	11:00, AM	1:00, PM	5:00, PM
WED :	8:00, AM	11:00, AM	1:00, PM	5:00, PM
THU :	8:00, AM	11:00, AM	1:00, PM	5:00, PM
FRI :	*			
SAT :				
SUN :				

*: All Day Space : No Use

Parameter	Value Range (default)	Description/Function	Reference
Number to Dial	Up to 32 digits of 1-9, 0, *, # P, T, M, X (None)	<p>Assigns the telephone or beeper number of Device 1.</p> <div style="border: 1px solid black; padding: 5px; width: fit-content;"> <p>P : Pause T : Dial Tone Detection M: Dial Mode X : Callback Number Entry Code 1-9, 0, *, #: Dial Codes</p> </div> <p>[Notes]</p> <ul style="list-style-type: none"> The callback number entry code "X" must be included in the number to be dialed, if "Beeper Callback No. Entry Mode" is activated by COS and "Type" is set to "Beeper". If you took the Quick Setup step to create mailboxes, each extension number has been already assigned to this parameter. (Applies only when your PBX type is T308 or T616.) 	<p>Callback Number Entry p.3-7</p> <p>M.W.N.-Device p.3-38</p> <p>Type p.4-24</p> <p>Beeper Callback No. Entry Mode p.4-33</p>

4.5.1 Setting up Mailboxes

Parameter	Value Range (default)	Description/Function	Reference
		<ul style="list-style-type: none"> Please insert proper number of pauses before callback number entry code 'X'. 	
Type	1. Telephone 2. Beeper (Telephone)	Specifies the device to be notified.	M.W.N.-Device p.3-38
Use Device	1. Not Use 2. Continuously 3. Scheduled (Continuously)	Specifies the usage of Device 1. 1. Not Use Device 1 is deactivated. 2. Continuously Device 1 is always active and receives notification calls whenever a message is recorded in the mailbox. 3. Scheduled Device 1 is active during the scheduled time.	
Note: The Subscriber can also specify the above three parameters using a telephone.			
Number of Retries	0-4 times (0)	Specifies the number of times that a notification call to Device 1 should be attempted after a busy or no answer condition.	
Busy Delay	2-120 min. (3)	Specifies the length of time in minutes the VPS is to wait after a busy condition before trying to make a notification call to Device 1 again.	
No Answer Delay	2-120 min. (30)	Specifies the length of time in minutes the VPS is to wait after a no answer condition before trying to make a notification call to Device 1 again.	
Time frame 1,2 MON : TUE : WED : THU : FRI : SAT : SUN :	1-12: hour 00-59: minute AM/PM: a.m./p.m. *: All Day Space: No Use	Specifies a weekly schedule for Message Waiting Notification. [Note] This parameter is valid only when "Use Device" is set to "Scheduled".	

Device 2, 3

Same as Device 1

4.5.1 Setting up Mailboxes

4.5.1.2 Deleting a Mailbox

When a Subscriber no longer needs a mailbox, he should ask you to delete it.

System Administration Top Menu → 1 → 1 → 2 → Mailbox No.

<p>Program – Mailbox Setting – Delete</p> <ol style="list-style-type: none">1. Enter/Edit2. Delete3. Password Reset4. Mailbox Listing <p>Enter the Mailbox Number : = XXX</p> <p><u>SELECT ITEM AND PRESS RETURN-KEY</u></p> <p>Are you sure ? (Y / N) : = *</p>

When a mailbox is deleted, the VPS will erase all messages in the mailbox, remove the mailbox from all group distribution lists, delete personal group distribution lists assigned to the mailbox, erase the Subscriber's name and cancel external delivery messages. While deleting a mailbox, the on-line service of the system must be stopped. See **Off-line Set** on page 7-2.

4.5.1.3 Resetting a Mailbox Password

If a Subscriber has forgotten his mailbox password, he can ask either you or the System Manager to delete his mailbox password so that the Subscriber can use a new one.

System Administration Top Menu → 1 → 1 → 3 → Mailbox No.

<p>Program – Mailbox Setting – Password Reset</p> <ol style="list-style-type: none">1. Enter/Edit2. Delete3. Password Reset4. Mailbox Listing <p>Enter the Mailbox Number : = XXX</p> <p><u>SELECT ITEM AND PRESS RETURN-KEY</u></p> <p>Are you sure ? (Y / N) : = *</p>

4.5.1 Setting up Mailboxes

4.5.1.4 Listing Mailboxes

You can display a list of all mailbox numbers registered in the system on the terminal.

System Administration Top Menu → 1 → 1 → 4

Program – Mailbox Setting – Mailbox – Listing

1:	2:	3:	4:	5:
6:	7:	8:	9:	10:
11:	12:	13:	14:	15:
16:	17:	18:	19:	20:
21:	22:	23:	24:	25:
26:	27:	28:	29:	30:
31:	32:	33:	34:	35:
36:	37:	38:	39:	40:
41:	42:	43:	44:	45:
46:	47:	48:	49:	50:
51:	52:	53:	54:	55:
56:	57:	58:	59:	60:
61:	62:			

System Manager's Mailbox No. : 999

Message Manager's Mailbox No. : 998

4.5.2 Setting COS (Class of Service) Parameters

Used to define a set of services available to Subscribers. A maximum of 64 (1-64) different classes of service can be established. You can assign a class of service number per each mailbox. More than one Subscriber can share the same Class of Service. All members who have the same COS number are allowed to use the same call services.

- Notes:**
- COS Nos. 1-62 have the same default values.
 - COS No. 63 is fixed to the Message Manager and No. 64 is fixed to the System Manager.

System Administration Top Menu → 1 → 2 → COS No. (1-64)

Program - Class of Service Menu
1. Class of Service Setting
2. Authorization Setting
<u>SELECT ITEM AND PRESS RETURN-KEY</u>

4.5.2.1 Class of Service Setting

COS Nos. 1-62 (for Subscribers)

System Administration Top Menu → 1 → 2 → COS No. (1-62) → 1

Program - Class of Service - Class of Service Setting Menu
CLASS OF SERVICE No. [1]
Personal Greeting Length (8-60 sec) _____ : 16
New Message Retention Time (1-30 days) _____ : 5
Saved Message Retention Time (1-30 days, 0: Unlimited) _____ : 5
Message Length (1-6 min.) _____ : 3
Mailbox Capacity Maximum Messages (5-100 msgs) _____ : 10
Mailbox Capacity Maximum Message Time (5-100 min.) _____ : 10
Message Retrieval Order _____ : LIFO
Message Scanning with Information _____ : No
Play System Prompt after Personal Greeting _____ : No
Use Call Waiting on Busy _____ : No
Message Cancel for Live Call screening _____ : Yes
Direct Mailbox Access _____ : Yes
Intercom Paging Group (1-8) _____ : 1
Prompt Mode _____ : USER 1

4.5.2 Setting COS (Class of Service) Parameters

COS Nos. 1-62

Parameter	Value Range (default)	Description/Function	Reference
Personal Greeting Length	8-60 sec in 4 seconds increments (16)	Defines the available length of the Personal Greeting message which can be recorded by the Subscriber. This parameter applies to: <ul style="list-style-type: none"> • Personal greeting on No-answer • Personal greeting on Busy • Personal greeting for After Hours 	Personal Greetings p.3-48
New Message Retention Time	1-30 days (5)	Defines the number of days a new message (= unplayed message) can remain in the mailbox. The days are counted from the next day of recording.	Mailbox Capacity p.3-35
Saved Message Retention Time	1-30 days 0: Unlimited (5)	Defines the number of days a saved message (already played message) can remain in the mailbox. The days are counted from the next day of the first message playback. If "0: Unlimited" is selected, the saved messages remain in the mailbox until they are erased by the Subscriber.	
Message Length	1-6 min. (3)	Defines the maximum length of one message that callers can leave in the mailbox.	
Mailbox Capacity Maximum Messages	5-100 msgs (10)	Specifies the maximum number of messages (including both new and saved) which can be held in one mailbox at a time. When you send a message using the Group Distribution List, the VPS will ignore this setting and send the message anytime.	
Mailbox Capacity Maximum Message Time	5-100 min. (10)	Specifies the total amount of time for messages (both new and saved) allowable in one mailbox.	
Message Retrieval Order	1. LIFO 2. FIFO (LIFO)	Specifies message retrieval order. 1. LIFO: Messages are played back from the newest to the oldest. 2. FIFO: Messages are played back from the oldest to the newest.	Receive Message p.3-50
Message Scanning with Information	1. Yes 2. No (No)	If set to "Yes", the VPS appends the message sender's name and the recording date and time to the message during message scan.	Message Scan p.3-37

4.5.2 Setting COS (Class of Service) Parameters

Parameter	Value Range (default)	Description/Function	Reference
Play System Prompt after Personal Greeting	1. Yes 2. No (No)	If set to "Yes", the VPS broadcasts the following guidance for message recording to the caller after the personal greeting. <div style="border: 1px solid black; padding: 5px; margin: 5px 0;"> <p><i>To end recording, hang up or press [1] for more features.</i></p> <p><i>To pause and restart recording, press [2].</i></p> </div>	Play System Prompt After Personal Greeting p.3-49
Use Call Waiting on Busy	1. Yes 2. No (No)	If set to "Yes", the VPS signals the busy extension that another call is waiting.	Call Waiting Sequence p.4-82
Message Cancel for Live Call Screening	1. Yes 2. No (Yes)	With the Live Call Screening feature, the Subscriber can monitor a messages being recorded in his own mailbox and can talk to the caller, if he wants to. In this case, the VPS continues to record the conversation unless it was deactivated by the PBX beforehand. If set to "Yes", the VPS will delete the recording. However, the Subscriber can hold the messages in his mailbox, if the following two conditions are satisfied: <ul style="list-style-type: none"> • The PBX allows the VPS to continue recording after starting the conversation. • The Subscriber press [1], then [2] before hanging up the phone. If set to "No", the VPS will save the recording automatically. [Note] Live Call Screening feature is available if D-PITS Voice Mail Integration with a Panasonic KX-TD series telephone system is activated.	Live Call Screening p.3-32 PBX Type p.4-79 Integration Mode p.4-81
Direct Mailbox Access	1. Yes 2. No (Yes)	If set to "Yes", the Subscriber enters the Subscriber service directly by simply calling a VPS extension from his own extension. There is no need to dial Subscriber service access code (* + mailbox number). However, password entry is required if it was specified beforehand. [Note] This feature is available if D-PITS Voice Mail Integration with a Panasonic KX-TD series telephone system is activated.	Direct Mailbox Access p.3-21 PBX Type p.4-79 Integration Mode p.4-81

4.5.2 Setting COS (Class of Service) Parameters

Parameter	Value Range (default)	Description/Function	Reference
Intercom Paging Group	1-8 (1)	Specifies the intercom paging group number available to the Subscriber. [Note] This feature is available if D-PITS Voice Mail Integration with a Panasonic KX-TD series telephone system is activated.	Incomplete Call Handling Service p.3-29 Intercom Paging Parameter p.4-71
Prompt Mode	1. SYSTEM 2. USER 1 3. USER 2 (USER 1)	Specifies the language of voice prompts that the VPS broadcasts to the Subscriber during a Message Waiting Notification call and Subscriber service. [Note] If User 1 or User 2 is specified as Prompt Mode but not recorded by the Message Manager, the VPS automatically broadcasts the factory recorded System prompts (English) to the Subscriber. By default, both User 1 and User 2 prompts are not recorded.	Subscriber Service p.3-56 Voice Prompts p.3-58 Recording User Prompts p.6-15

COS Nos. 63, 64 (for Managers)

System Administration Top Menu → 1 → 2 → COS No. (63, 64) → 1

Program – Class of Service – Class of Service Setting Menu	
CLASS OF SERVICE No. [63] (for Message Manager)	
Personal Greeting Length (8-60 sec) _____	: —
New Message Retention Time (1-30 days) _____	: 30
Saved Message Retention Time (1-30 days, 0: Unlimited) —	: 30
Message Length (1-6 min.) _____	: 6
Mailbox Capacity Maximum Messages (5-100 msgs) _____	: 100
Mailbox Capacity Maximum Message Time (5-100 min.) _____	: 100
Message Retrieval Order _____	: LIFO
Message Scanning with Information _____	: No
Play System Prompt after Personal Greeting _____	: —
Use Call Waiting on Busy _____	: —
Message Cancel for Live Call screening _____	: —
Direct Mailbox Access _____	: —
Intercom Paging Group (1-8) _____	: —
Prompt Mode _____	: —

4.5.2 Setting COS (Class of Service) Parameters

COS Nos. 63, 64

Parameter	Value Range (default)	Description/Function	Reference
New Message Retention Time	1-30 days (30)	Defines the number of days a new message (= unplayed message) can remain in the mailbox. The days are counted from the next day of message recording.	Mailbox Capacity p.3-35
Saved Message Retention Time	1-30 days 0: Unlimited (30)	Defines the number of days a saved message (already played message) can remain in the mailbox. The days are counted from the next day of the first message playback. If "0: unlimited" is selected, the saved messages remain in the mailbox until they are erased by the mailbox owner.	
Message Length	1-6 min. (6)	Defines the maximum length of one message that callers can leave in the mailbox.	
Mailbox Capacity Maximum Messages	5-100 msgs (100)	Specifies the maximum number of messages (including both new and saved) which can be held in one mailbox at a time.	
Mailbox Capacity Maximum Message Time	5-100 min. (100)	Specifies the total amount of time for messages (both new and saved) allowable in one mailbox.	
Message Retrieval Order	1. LIFO 2. FIFO (LIFO)	Specifies message retrieval order. 1. LIFO: Messages are played back from the newest to the oldest. 2. FIFO: Messages are played back from the oldest to the newest.	Receive Message p.3-50
Message Scanning with Information	1. Yes 2. No (No)	If set to "Yes", the VPS appends the message sender's name and the recording date and time to the message during message scan.	Message Scan p.3-37

Note: Parameters other than those listed above are not assignable for COS Nos. 63 and 64.

4.5.2 Setting COS (Class of Service) Parameters

4.5.2.2 Special Feature Authorization

Allows the Subscriber to utilize the following special features on a COS basis.

Message Waiting Notification

External Message Delivery

Auto Forwarding

All these features are prohibited when a new mailbox is created. You must authorize the necessary features.

- Notes:**
- For managers, Message Notification for the Message Manager can only be activated or deactivated by this programming. Other parameters are not assignable.
 - If a special feature authorization is set to "No", sub-parameters are not assignable.

COS Nos. 1-62 (for Subscribers)

System Administration Top Menu → 1 → 2 → COS No. (1-62) → 2

Program – Class of Service – Authorization Setting Menu

CLASS OF SERVICE No. [1]

Authorization of Message Notification	_____	: No
Beeper Callback No. Entry Mode	_____	: ---
MWL Notification for Unreceived Message	_____	: ---
Device Notification for Unreceived Message	_____	: ---
Authorization of External Message Delivery	_____	: No
Prompt Mode	_____	: ---
Authorization of Auto Forwarding	_____	: No
Mailbox Number	_____	: ---
Delay Time	_____	: ---
Forwarding Mode	_____	: ---

4.5.2 Setting COS (Class of Service) Parameters

Parameter	Value Range (default)	Description/Function	Reference
Authorization of Message Notification	1. Yes 2. No (No)	If set to "Yes", Subscribers can utilize the Message Waiting Notification feature. [Note] If you took the Quick Setup step to create mailboxes, this parameter in COS No. 1 has been already set to "Yes".	M.W.N. p.3-38, 3-41 Notification Setting p.4-22
Beeper Callback No. Entry Mode	1. Select 2. Without 3. Before 4. After 5. Disable (None)	Allows or prohibits the Subscriber to utilize the Callback Number Entry feature. Select: After message recording, the VPS will ask the caller if the message is urgent. If specified as urgent, the VPS will ask the caller to enter his callback number. Without: Without message recording, the VPS will ask the caller to enter his callback number. Before: Before message recording, the VPS will ask the caller to enter his callback number. After: After message recording, the VPS will ask the caller to enter his callback number. Disable: The VPS will not ask the caller to enter his callback number. [Notes] • To utilize this feature, the beeper number must include the callback number entry code "X". See "Notification Setting" in page 4-22. • When "Disable" is selected or the caller does not enter his callback number, System Callback No. will be displayed on the beeper's display.	Callback Number Entry p.3-7 Number to Dial p.4-23 Type p.4-24 Max. Digits for Callback No./ Callback No. Entry Interdigit Time-Out p.4-67 System Callback No. p.4-68
MWL Notification for Unreceived Message	1. Yes 2. No (None)	Lets the VPS turn on the message waiting lamp again, if unplayed messages are still left in the mailbox after the Subscriber' access.	M.W.N.-Lamp p.3-41
Device Notification for Unreceived Message	1. Yes 2. No (None)	Lets the VPS call devices, if unplayed messages are still left in the mailbox after the Subscriber's access.	M.W.N.-Device p.3-38 Type p.4-24

4.5.2 Setting COS (Class of Service) Parameters

Parameter	Value Range (default)	Description/Function	Reference
Authorization of External Message Delivery	1. Yes 2. No (No)	Allows the Subscriber to utilize the External Message Delivery feature.	E.M.D. Service p.3-22
Prompt Mode	1. System 2. User 1 3. User 2 4. Selective (None)	Specifies in which language the voice prompts of external messages are played.	Multi-Lingual Service p.3-42 E.M.D. Parameters p.4-68
Authorization of Auto Forwarding	1. Yes 2. No (No)	Forwards messages to another mailbox if they have not been listened to for a specific length of time.	Auto Forwarding p.3-3
Mailbox Number	2-5 digits (None)	Specifies the mailbox number where unlistened messages will be forwarded. [Note] A mailbox group list number cannot be assigned to this parameter.	New Message Retention Time p.4-28
Delay Time	(Hr.) (Min) 00 : 05 99 : 59 (None)	Specifies the length of time in both hours and minutes the VPS is to wait before forwarding the unlistened messages. If new messages are not received by the Subscriber before this time expires, the VPS forwards them to the destination mailbox. The maximum delay time is 99 hours, 59 minutes (more than four days). [Note] The delay time must be shorter than the New Message Retention Time. Otherwise, messages will be deleted before being forwarded.	
Forwarding Mode	1. Copy 2. Move (None)	Specifies whether or not the forwarded messages should be retained in the original mailbox. If set to "Copy", a copy of the message is retained in the original mailbox after the message has been forwarded to another mailbox. If set to "Move", only the mailbox to which the message was forwarded has the message.	

4.5.2 Setting COS (Class of Service) Parameters

COS No. 63 (for Message Manager)

COS No. 63 is fixed to the Message Manager and only "Authorization of Message Notification" can be activated or deactivated by the programming. External Message Delivery and Auto Forwarding are not assignable.

System Administration Top Menu → 1 → 2 → COS No. (63) → 2

Program – Class of Service – Authorization Setting Menu	
CLASS OF SERVICE No. [63] (for Message Manager)	
Authorization of Message Notification	: Yes
Beeper Callback No. Entry Mode	: Disable
MWL Notification for Unreceived Message	: No
Device Notification for Unreceived Message	: No
Authorization of External Message Delivery	: - - -
Prompt Mode	: - - -
Authorization of Auto Forwarding	: - - -
Mailbox Number	: - - -
Delay Time	: - - -
Forwarding Mode	: - - -

COS No. 63

Parameter	Value Range (default)	Description/Function	Reference
Authorization of Message Notification	1. Yes 2. No (Yes)	If set to "Yes", the Message Manager can utilize the Message Waiting Notification feature.	M.W.N. p.3-38, 3-41 Notification Setting p.4-22
Beeper Callback No. Entry Mode	1. Select 2. Without 3. Before 4. After 5. Disable (Disable)	Allows or prohibits the Message Manager to utilize the Callback Number Entry feature. Select: After message recording, the VPS will ask the caller if the message is urgent. If specified as urgent, the VPS will ask the caller to enter his callback number. Without: Without message recording, the VPS will ask the caller to enter his callback number. Before: Before message recording, the VPS will ask the caller to enter his callback number.	Callback Number Entry p.3-7 Number to Dial p.4-23 Type p.4-24

4.5.2 Setting COS (Class of Service) Parameters

COS No. 63

Parameter	Value Range (default)	Description/Function	Reference
		<p>After: After message recording, the VPS will ask the caller to enter his callback number.</p> <p>Disable: The VPS will not ask the caller to enter his callback number.</p> <p>[Notes]</p> <ul style="list-style-type: none"> To utilize this feature, callback number entry code "X" should be included in the Message Manager's beeper number. See "Notification Setting" no page 4-22. When "Disable" is selected or the caller does not enter his callback number, System Callback No. will be displayed on the beeper's display. 	<p>Max. Digits for Callback No./ Callback No. Entry Interdigit Time-Out p.4-67</p> <p>System Callback No. p.4-68</p>
MWL Notification for Unreceived Message	<p>1. Yes</p> <p>2. No (No)</p>	Lets the VPS turn on the message waiting lamp again, if unplayed messages are still left in the mailbox after the Message Manager's access.	M.W.N.-Lamp p.3-41
Device Notification for Unreceived Message	<p>1. Yes</p> <p>2. No (No)</p>	Lets the VPS call devices, if unplayed messages are still left in the mailbox after the Message Manager's access.	<p>M.W.N.-Device p.3-38</p> <p>Type p.4-24</p>

COS No. 64 (for System Manager)

COS No. 64 is fixed to the System Manager and all Authorization settings are not assignable.

4.5.3 Port Service

Each VPS port has Day and Night mode. One of four incoming call services can be assigned to each VPS port: Voice Mail, Automated Attendant, Interview service and Custom service.

The Port Assignment menu also lets you specify company greeting number, prompt mode and delayed answer time.

System Administration Top Menu → 1 → 3

Program – Port Service Menu
1. Port 1
2. Port 2
3. Port 3
4. Port 4
<u>SELECT ITEM AND PRESS RETURN-KEY</u>

4.5.3.1 Port Assignment

System Administration Top Menu → 1 → 3 → 1

Program – Port Service – Port1 Menu
1. Day Mode
2. Night Mode
<u>SELECT ITEM AND PRESS RETURN-KEY</u>

Port 1 – Day Mode

System Administration Top Menu → 1 → 3 → 1 → 1

Program – Port Service – Port1 – Day Mode Menu
Company Greeting No. (1-32) _____ :
Incoming Call Service _____ : Auto. Attn.
Incoming Call Service Prompt _____ : User 1
Delayed Answer Time (0-15 sec) _____ : 0

4.5.3 Port Service

Parameter	Value Range (default)	Description/Function	Reference
Company Greeting No.	1-32 (None)	Specifies which Company Greeting greets the callers to this port.	Company Greetings p.3-12 Recording Company Greetings p.6-12
Incoming Call Service	1. Voice Mail 2. Auto. Attn. 3. Interview 4. Custom (Auto. Attn.)	Specifies one of four incoming call services. [Notes] • When you specify the Interview service, one of Subscriber's Interview mailbox numbers should also be specified. • When you specify the Custom service, one of 100 (1-100) Custom service numbers should also be specified.	A.A. Service p.3-4 Custom Service p.3-13 Interview Service p.3-31 V.M. Service p.3-56
Incoming Call Service Prompt	1. System 2. User 1 3. User 2 4. Selective (User 1)	Specifies the language of voice prompts which provide the operation guidance of the VPS to the caller to this port. [Notes] • This parameter is not valid if incoming call service is set to "Interview" or "Custom". • If "Selective" is specified, you will need to select a prompt available for rotary callers. See "Prompt for Rotary Callers" below.	Multi-Lingual Service p.3-42 Voice Prompts p.3-58 Prompt Setting p.4-62
Prompt for Rotary Callers	1. System 2. User 1 3. User 2 (System)	Specifies in which language rotary callers hear the voice prompts when they cannot enter any digit to select a "Prompt Selection Number" while Multi-Lingual selection menu message is being played.	None
Delayed Answer Time	0-15 sec (0)	Specifies whether the VPS answers incoming calls immediately (0) or in a delayed timing (1-60 sec).	None

Note: Callers are generally accustomed to their calls being answered within 10 seconds and most callers abandon the call in under 45 seconds if no reply is obtained. This unit will answer incoming calls in under 10 seconds if required. (Delayed Answer Time)

4.5.3 Port Service

Port 1 – Night Mode

System Administration Top Menu → 1 → 3 → 1 → 2

Program – Port Service – Port1 – Night Mode Menu

Company Greeting No. (1-32) -----	:
Incoming Call Service -----	:	Auto. Attn.
Incoming Call Service Prompt -----	:	User 1
Delayed Answer Time (0-15 sec) -----	:	0

Descriptions are same as Port 1 – Day Mode.

Port 2, 3, 4 – Day Mode

Same as Port 1 – Day Mode

Port 1, 2, 3, 4 – Night Mode

Same as Port 1 – Day Mode

4.5.4 Service Settings

System Administration Top Menu → 1 → 4

Program – Service Set Menu
1. Automated Attendant
2. Custom Service Settings
SELECT ITEM AND PRESS RETURN-KEY

4.5.4.1 Automated Attendant Parameters

The Automated Attendant service in the call service has three main functions: Department or Speed Dialing; Operator's Parameters; Alternate Extension.

System Administration Top Menu → 1 → 4 → 1

Program – Service Set – Auto. Attn. Menu
1. Department Dialing
2. Operator's Parameters
3. Alternate Extension
SELECT ITEM AND PRESS RETURN-KEY

4.5.4.1.1 Department Dialing

Department Dialing is a speed dialing feature which allows the caller to reach his desired extension by simply dialing one digit (1 through 9).

System Administration Top Menu → 1 → 4 → 1 → 1

Program – Service Set – Auto. Attn. – Department Dialing Menu
Department Dialing No. 1 _____ : . . .
Department Dialing No. 2 _____ : . . .
Department Dialing No. 3 _____ : . . .
Department Dialing No. 4 _____ : . . .
Department Dialing No. 5 _____ : . . .
Department Dialing No. 6 _____ : . . .
Department Dialing No. 7 _____ : . . .
Department Dialing No. 8 _____ : . . .
Department Dialing No. 9 _____ : . . .

4.5.4 Service Settings

Parameter	Value Range (default)	Description/Function	Reference
Department Dialing No. 1-9	2-5 digits (None)	Specifies any valid extension number. [Note] The department dialing menu can be recorded by the Message Manager.	Department Dialing p.3-19 Recording Department Dialing Menu Messages p.6-13

4.5.4.1.2 Operator's Parameters

Specifies the operators' (Operator 1, 2, 3) extensions, mailboxes and the treatment of operator-seeking calls.

Operator's parameters can be set for both Day and Night mode individually.

System Administration Top Menu → 1 → 4 → 1 → 2

Program – Service Set – Auto. Attn. – Operator Menu

1. Day Mode
2. Night Mode

SELECT ITEM AND PRESS RETURN-KEY

System Administration Top Menu → 1 → 4 → 1 → 2 → 1

Program – Service Set – Auto. Attn. – Operator – Day Mode Menu

1. Operator 1
2. Operator 2
3. Operator 3

4.5.4 Service Settings

Operator 1 – Day Mode

Activates or deactivates the Operator service, specifies Operator 1's extension and the treatment of calls transferred to Operator 1's extension. When Operator service is activated, operator-seeking calls are first transferred to Operator 1's extension.

System Administration Top Menu → 1 → 4 → 1 → 2 → 1 → 1

Program – Service Set – Auto. Attn. – Operator – Day Mode – Operator 1 Menu

Operator Service	:	Enable
Operator's Extension	:	0
Operator's Mailbox No.	:	998
Operator No-answer Time (10-60 sec)	:	30
Busy Coverage Mode	:	Hold
No-answer Coverage Mode	:	Caller Select
Message Repeat Cycle	:	3

Parameter	Value Range (default)	Description/Function	Reference
Operator Service	1. Disable 2. Enable (Enable)	Activates or deactivates the Operator service. [Note] If the Operator service is deactivated, operator-seeking calls are transferred to the General Delivery Mailbox.	M.W.N.-Lamp p.3-41 Operator Service p.3-46
Operator's Extension	2-5 digits (0)	Specifies Operator 1's extension number. [Note] The default setting (0) is not applicable to the Message Waiting Notification-Lamp feature. For the Operator 1 to have this feature, assign an extension number which comes under the Extension Numbering Plan.	Extension Numbering Plan p.4-63 Operator's Extensions p.6-10
Operator's Mailbox No.	2-5 digits (998)	The caller to Operator 1's extension may be prompted to leave a message in this mailbox depending on the settings of "Busy Coverage Mode" or "No-answer Coverage Mode".	Managing the G.D.M. p.6-5

4.5.4 Service Settings

Parameter	Value Range (default)	Description/Function	Reference
Operator No-answer Time	10–60 sec (30)	If a call to Operator 1, 2 or 3 is not answered within this parameter, the VPS will offer the caller other options defined by "No-answer Coverage Mode". [Note] This timer applies to Operators 1, 2 and 3.	No-Answer Coverage Mode p.3-46
Busy Coverage Mode	1. Hold 2. No-answer Coverage 3. Call Waiting 4. Disconnect Message (Hold)	Specifies how to treat calls when Operator 1 is busy. 1. Hold The VPS calls Operator 1 again while putting the caller on hold. 2. No-answer Coverage The VPS offers an option defined by "No-answer Coverage Mode" to the caller. 3. Call Waiting The VPS signals Operator 1 on busy that another call is waiting using the Call Waiting feature of the PBX. 4. Disconnect Message The VPS disconnects the call after playing "Thank you for calling".	Busy Coverage Mode p.3-7
No-answer Coverage Mode	1. Caller Select 2. Leave Message 3. Disconnect Message 4. Next Operator (Caller Select)	Specifies how to treat calls when Operator 1 does not answer it within the time length defined by "Operator No-answer Time". 1. Caller Select The VPS offers the following two options to the caller. (a) Leave a message (b) Call another extension 2. Leave Message The VPS prompts the caller to leave a message in Operator 1's mailbox. 3. Disconnect Message The VPS disconnects the call after playing "Thank you for calling". 4. Next Operator The VPS transfers the call to Operator 2.	No-Answer Coverage Mode p.3-46 Operator No-answer Time p.4-43

4.5.4 Service Settings

Parameter	Value Range (default)	Description/Function	Reference
Message Repeat Cycle	1-3 times (3)	Specifies the number of times the VPS plays the option selection message to the caller, when "Caller Select" is specified as "No-answer Coverage Mode". [Note] This parameter applies to Operators 1, 2 and 3.	

Note: Interaction of Extension Call Forwarding with Operator Call Coverage Settings.

Extension call forwarding to the VPS may override the operator call coverage settings depending on the timing parameters of the PBX and VPS. Even if the operator call coverage parameters are set to forward to the next operator on busy/no answer, the call may go to the VPS if the Operator has set the call forwarding to the VPS on his extension.

Operator 2 - Day Mode

Operator-seeking calls come in on Operator 2 when Operator 1 is busy or unanswered and Operator 1's parameters are set as follows.

Busy Coverage Mode → No-answer Coverage

No-answer Coverage Mode → Next Operator

System Administration Top Menu → 1 → 4 → 1 → 2 → 1 → 2

Program - Service Set - Auto. Attn. - Operator - Day Mode - Operator 2 Menu

Operator's Extension _____ : ---
 Operator's Mailbox No. _____ : ---
 Busy Coverage Mode _____ : Hold
 No Answer Coverage Mode _____ : Caller Select

Operator's Service is Enable

4.5.4 Service Settings

Parameter	Value Range (default)	Description/Function	Reference
Operator's Extension	2-5 digits (None)	Specifies Operator 2's extension number. Any valid extension number can be assigned.	Operator Service p.3-46
Operator's Mailbox No.	2-5 digits (None)	Specifies Operator 2's mailbox number. Any valid mailbox number can be assigned. The caller to Operator 2's extension may be prompted to leave a message in this mailbox depending on the settings of "Busy Coverage Mode" or "No-answer Coverage Mode".	Busy Coverage Mode p.3-7 No-Answer Coverage Mode p.3-46
Busy Coverage Mode	<ol style="list-style-type: none"> 1. Hold 2. No-answer Coverage 3. Call Waiting 4. Disconnect Message (Hold) 	<p>Specifies how to treat calls when Operator 2 is busy.</p> <ol style="list-style-type: none"> 1. Hold The VPS calls Operator 2 again while putting the caller on hold. 2. No-answer Coverage The VPS offers an option defined by "No-answer Coverage Mode" to the caller. 3. Call Waiting The VPS signals Operator 2 on busy that another call is waiting using the Call Waiting feature of the PBX. 4. Disconnect Message The VPS disconnects the call after playing "Thank you for calling". 	
No-answer Coverage Mode	<ol style="list-style-type: none"> 1. Caller Select 2. Leave Message 3. Disconnect Message 4. Next Operator (Caller Select) 	<p>Specifies how to treat calls when Operator 2 does not answer it within the time length defined by "Operator No-answer Time".</p> <ol style="list-style-type: none"> 1. Caller Select The VPS offers the following two options to the caller. <ol style="list-style-type: none"> (a) Leave a message (b) Call another extension 2. Leave Message The VPS prompts the caller to leave a message in Operator 2's mailbox. 3. Disconnect Message The VPS disconnects the call after playing "Thank you for calling". 4. Next Operator The VPS transfers the call to Operator 3. 	No-Answer Coverage Mode p.3-46 Operator No-answer Time p.4-43

4.5.4 Service Settings

Operator 3 – Day Mode

Operator-seeking calls come in to Operator 3, when Operator 2 is busy or there is no answer and Operator 2's parameters are set as follows.

Busy Coverage Mode → No-answer Coverage

No-answer Coverage Mode → Next Operator

System Administration Top Menu → 1 → 4 → 1 → 2 → 1 → 3

Program – Service Set – Auto. Attn. – Operator – Day Mode – Operator 3 Menu	
Operator's Extension _____	: ---
Operator's Mailbox No. _____	: ---
Busy Coverage Mode _____	: Hold
No-answer Coverage Mode _____	: Caller Select
Operator's Service is Enable	

Parameter	Value Range (default)	Description/Function	Reference
Operator's Extension	2–5 digits (None)	Specifies Operator 3's extension number. Any valid extension number can be assigned.	Operator Service p.3-46
Operator's Mailbox No.	2–5 digits (None)	Specifies Operator 3's mailbox number. Any valid mailbox number can be assigned. The caller to operator 3's extension may be prompted to leave a message in this mailbox depending on the settings of "Busy Coverage Mode" or "No-answer Coverage Mode".	Busy Coverage Mode p.3-7 No-Answer Coverage Mode p.3-46
Busy Coverage Mode	1. Hold 2. No-answer Coverage 3. Call Waiting 4. Disconnect Message (Hold)	Specifies how to treat calls when Operator 3 is busy. 1. Hold The VPS calls Operator 3 again while putting the caller on hold. 2. No-answer Coverage The VPS offers an option defined by "No-answer Coverage Mode" to the caller. 3. Call Waiting The VPS signals Operator 3 on busy that another call is waiting using the Call Waiting feature of the PBX. 4. Disconnect Message The VPS disconnects the call after playing "Thank you for calling".	

4.5.4 Service Settings

Parameter	Value Range (default)	Description/Function	Reference
No-answer Coverage Mode	<ol style="list-style-type: none"> 1. Caller Select 2. Leave Message 3. Disconnect Message (Caller Select) 	<p>Specifies how to treat calls when Operator 3 does not answer it within the time length defined by "Operator No-answer Time".</p> <ol style="list-style-type: none"> 1. Caller Select The VPS offers the following two options to the caller. <ol style="list-style-type: none"> (a) Leave a message (b) Call another extension 2. Leave Message The VPS prompts the caller to leave a message in Operator 3's mailbox. 3. Disconnect Message The VPS disconnects the call after playing "Thank you for calling". 	<p>No Answer Coverage Mode p.3-46</p> <p>Operator No-answer Time p.4-43</p>

- Notes:**
- An Operator-seeking call is always transferred to Operator 1 first. It will be transferred to Operator 2 and then Operator 3 depending on System Programming.
 - "Next Operator" cannot be set in "No-answer Coverage Mode" of Operator 3.

Operator 1 – Night Mode

Same as Operator 1 – Day Mode

Operator 2 – Night Mode

Same as Operator 2 – Day Mode

Operator 3 – Night Mode

Same as Operator 3 – Day Mode

4.5.4 Service Settings

4.5.4.1.3 Alternate Extension Assignment

Used to assign extensions which should be transferred differently from normal extension transfer sequences. Calls to the extensions in this group will be transferred following the sequence defined by "Alternate Extension Transfer Sequence" (see page 4-82).

System Administration Top Menu → 1 → 4 → 1 → 3

Program – Service Set – Auto. Attn. – Alternate Extn. Menu

1. Enter Extension
2. Delete Extension
3. Extension Listing

SELECT ITEM AND PRESS RETURN-KEY

Alternate Extension Group – Enter

You can put 32 extensions together in a group to use the alternate transfer sequence.

System Administration Top Menu → 1 → 4 → 1 → 3 → 1

Program – Service Set – Auto. Attn. – Alternate Extn. – Enter Extension

1:	2:	3:	4:
5:	6:	7:	8:
9:	10:	11:	12:
13:	14:	15:	16:
17:	18:	19:	20:
21:	22:	23:	24:
25:	26:	27:	28:
29:	30:	31:	32:

Enter the Extension Number : = *

4.5.4 Service Settings

Parameter	Value Range (default)	Description/Function	Reference
Alternate Extension (1-32)	2-5 digits (None)	Specifies an extension which requires different transfer sequence than normal extension transfer sequence.	Alternate Extension Group p.3-3 Alternate Extension Transfer Sequence p.4-82

Alternate Extension – Delete

You can delete extension numbers from the alternate extension group.

System Administration Top Menu → 1 → 4 → 1 → 3 → 2

Program – Service Set – Auto. Attn. – Alternate Extn. – Delete Extension			
1:	2:	3:	4:
5:	6:	7:	8:
9:	10:	11:	12:
13:	14:	15:	16:
17:	18:	19:	20:
21:	22:	23:	24:
25:	26:	27:	28:
29:	30:	31:	32:
Enter the Number You Want to Delete : = *			

Alternate Extension – Listing

You can list up all extensions registered in the alternate extension group.

System Administration Top Menu → 1 → 4 → 1 → 3 → 3

Program – Service Set – Auto. Attn. – Alternate Extn. – Extension Listing			
1:	2:	3:	4:
5:	6:	7:	8:
9:	10:	11:	12:
13:	14:	15:	16:
17:	18:	19:	20:
21:	22:	23:	24:
25:	26:	27:	28:
29:	30:	31:	32:

4.5.4 Service Settings

4.5.4.2 Custom Service

Custom service is one of four incoming call services.

By assigning a function to each key, you can provide a customized key-operation service to callers.

You can set a maximum of 100 custom services.

System Administration Top Menu → 1 → 4 → 2 → Custom Service No. (1-100)

Program – Service Setting – Custom Service Setting – Custom 1		
Description	_____	:
Prompt Mode (1: Sys 2: User 1 3: User 2)	_____	: System
Menu Repeat Cycle (1-3)	_____	: 3 times
Call Transfer Anytime (Extn. / Mbx / No)	_____	: Extn.
Wait for Second Digit (1-5 seconds)	_____	: 1 seconds
No DTMF Input Operation (a-f)	_____	: c
Keypad Assignment		
1:	2:	3:
4:	5:	6:
7:	8:	9:
*: d	0: c	#: .
Please choose one of the following functions or services.		
a. Transfer to Mailbox	h. Call Transfer Service	
b. Transfer to Extension	i. Subscriber Service	
c. Operator	j. Department Dialing	
d. Exit	k. Dial by Name	
e. Previous Menu	l. Repeat Menu	
f. Custom Service	m. Main Menu	
g. Voice Mail Service	n. FAX Transfer	

Note: Custom Service Report (CREP)

After programming a Custom service, you can confirm the keypad assignments, message recording status and the tree-structure of a Custom service by displaying Custom service report on the terminal. See page 7-11.

In this report, you can also confirm the number of times a certain Custom service has been accessed by callers.

Parameter	Value Range (default)	Description/Function	Reference
Description	Up to 32 alphanumeric characters (None)	The information typed in this field is for your reference only.	Custom Service p.3-13

4.5.4 Service Settings

Parameter	Value Range (default)	Description/Function	Reference
Prompt Mode	1. System 2. User 1 3. User 2 (System)	Specifies the language of a custom service menu message that the caller to this Custom service will hear as a guidance. [Note] This parameter overrides "Incoming Call Service Prompt".	Multi-Lingual Service p.3-42 Incoming Call Service Prompt p.4-38
Menu Repeat Cycle	1-3 times (3)	Specifies the number of times custom service menu messages are repeated to the caller. [Note] "Custom 1" on the top of the programming screen (see the previous page) is highlighted, if menu message for Custom 1 was recorded by the Message Manager beforehand. This is available in the VT100 mode only.	Recording Custom Service Menu Messages p.6-14
Call Transfer Anytime	Extn./Mbx/ No (Extn.)	Specifies where the call is transferred during the custom service top menu. The "Extn." setting (enter "E") enables the caller to be transferred directly to his desired party by dialing the extension number. The "Mbx" setting (enter "M") enables the caller to leave messages in the mailbox by entering the mailbox number of the person to whom caller wishes to leave messages. The "No" setting (enter "N") deactivates call transfer.	Port service setting p.4-12
Wait for Second Digit	1-5 sec (1)	Used to resolve the problem that the first digit of the extension or mailbox number is the same as one of the custom service menu choices. The VPS will wait for a second digit for this amount of time. If this timer expires, the VPS assumes that the caller wants to choose the menu and not to transfer a call. This parameter is used only if "Call Transfer Anytime" is set to "Extn." or "Mbx".	
No DTMF Input Operation	a-f (c) *See Keypad Assignment on the next page for details.	Specifies how to treat the caller who does not respond to the menu message. This occurs when the caller is using a rotary phone. The factory setting is "c. Operator", that is, the caller is automatically connected to the operator immediately after the playback of menu message has finished.	Rotary Telephone Service p.3-52

4.5.4 Service Settings

Parameter	Value Range (default)	Description/Function	Reference
Keypad Assignment 0 - 9, *, #	a-n (*: d, 0: c Others: None)	<p>You can assign any of the 14 services listed below (a - n) to 0 through 9, * and # keys on the telephone keypad. Callers are then able to access these services by pressing the corresponding keys on their telephones.</p> <ul style="list-style-type: none"> (a) Transfer to Mailbox Allows the caller to leave messages in a specific mailbox. Enter "a" followed by a mailbox number. (b) Transfer to Extension Transfers the caller to a specific extension. Enter "b" followed by an extension number. (c) Operator Connects the caller to the operator. (d) Exit Plays a final guidance message and disconnects. The message must be recorded by the Message Manager. (e) Previous Menu Allows the caller to access previous Custom service menu, if programmed. (f) Custom Service Allows the caller to access another Custom service, if programmed. (g) Voice Mail Service Allows the caller to access the Voice Mail service. (h) Call Transfer Service Allows the caller to access the Call Transfer service. (i) Subscriber Service Allows the caller to access the Subscriber service. (Available only when calls are from Subscribers) (j) Department Dialing Transfers the caller to the department dialing menu. (k) Dial by Name Lets the caller transfer to an extension by dialing the first three or four letters of the extension owner's last name. (l) Repeat Menu Repeats the Custom service menu message once. (m) Main Menu Lets the caller return directly to the top Custom service menu. (n) FAX Transfer Enables the caller to send a fax message to the appropriate extension, that is, a fax machine. 	<p>A.A. Service p.3-4</p> <p>Custom Service p.3-13</p> <p>Department Dialing p.3-19</p> <p>Dialing by Name p.3-20</p> <p>Fax Management p.3-24</p> <p>Operator Service p.3-46</p> <p>Voice Mail Service p.3-56</p>

4.5.5 System Parameter Settings

System Administration Top Menu → 1 → 5

Program – System Parameter Menu

1. System Group Assignment
2. Day Service
3. Holiday Setting
4. Daylight Saving Time
5. Prompt Setting
6. Others

SELECT ITEM AND PRESS RETURN-KEY

4.5.5.1 System Group Assignment

System Administration Top Menu → 1 → 5 → 1

Program – System Parameter – System Group Assignment Menu

1. Mailbox Group
2. Extension Group

SELECT ITEM AND PRESS RETURN-KEY

4.5.5.1.1 Mailbox Group

A Subscriber may sometimes want to send a message simultaneously to several mailboxes. These mailboxes may be put together into a list, known as a mailbox group list. The VPS can have up to 20 system mailbox group lists. Each mailbox group list can have up to 20 destination mailbox numbers. You can add, delete and review members in specified lists.

System Administration Top Menu → 1 → 5 → 1 → 1 → 1

Program – System Parameter – System Group Assignment – Mailbox Group – Enter

1. Enter
2. Delete
3. Group Listing

Enter the Mailbox Group List Number : = *

4.5.5 System Parameter Settings

Mailbox Group – Enter

System Administration Top Menu → 1 → 5 → 1 → 1 → 1 → Group List No.

Program – System Parameter – System Group Assignment – Mailbox – Enter				
MAILBOX GROUP LIST No. [XXX]				
Mailbox Group Name _____ :				
1:	2:	3:	4:	5:
6:	7:	8:	9:	10:
11:	12:	13:	14:	15:
16:	17:	18:	19:	20:
<u>Enter the Mailbox Number</u>				
: = *				

Parameter	Value Range (default)	Description/Function	Reference
Mailbox Group List No.	2-5 digits (None)	Specifies any vacant mailbox number. The Subscriber can transfer or deliver messages to all members of this group by simply specifying the Group List No.	Group Distribution List, System p.3-25
Group Name	Up to 16 characters	Enter the name for your reference. Press [RETURN] to skip this setting.	Recording Voice Labels for Mailbox Lists p.6-15
Member (1-20)	2-5 digits (None)	Specifies mailbox numbers belonging to this group.	None

Mailbox Group – Delete

You can specify mailbox numbers to be deleted from the list.

4.5.5 System Parameter Settings

System Administration Top Menu → 1 → 5 → 1 → 1 → 2 → Group List No.

Program – System Parameter – System Group Assignment – Mailbox – Delete				
MAILBOX GROUP LIST No. [XXX]				
Mailbox Group Name _____ : VOICE MAIL GROUP				
1:	2:	3:	4:	5:
6:	7:	8:	9:	10:
11:	12:	13:	14:	15:
16:	17:	18:	19:	20:
<u>Enter the Number You Want to Delete</u>				
: = *				

Mailbox Group – Listing

This displays all Mailbox Group List numbers.

System Administration Top Menu → 1 → 5 → 1 → 1 → 3

Program – System Parameter – System Group Assignment – Mailbox – Group Listing		
1: 12345	Mbx Group Name 1	11:
2: 11111	Mbx Group Name 2	12:
3:		13:
4:		14:
5:		15:
6:		16:
7:		17:
8:		18:
9:		19:
10:		20:

4.5.5.1.2 Extension Group

You can put several extensions together into a list. The VPS can have up to 20 system extension group lists. Each group can have up to 20 extensions.

You can add, delete and review members in specified lists.

The members in a list can share the same mailbox and can also be notified by message waiting notification lamp at the same time, if authorized.

4.5.5 System Parameter Settings

System Administration Top Menu → 1 → 5 → 1 → 2 → 1

<p>Program – System Parameter – System Group Assignment – Extension Group – Enter</p> <p>1. Enter 2. Delete 3. Group Listing</p> <p>Enter the Extension Group List Number (2–5 digits): = *</p>

Extension Group – Enter

System Administration Top Menu → 1 → 5 → 1 → 2 → 1 → Group List No.

<p>Program – System Parameter – System Group Assignment – Extension – Enter</p> <p>EXTENSION GROUP LIST No. [XXX]</p> <p>Extension Group Name _____ : EXTENSION GROUP</p> <table style="width: 100%; text-align: center;"> <tr> <td>1:</td> <td>2:</td> <td>3:</td> <td>4:</td> <td>5:</td> </tr> <tr> <td>6:</td> <td>7:</td> <td>8:</td> <td>9:</td> <td>10:</td> </tr> <tr> <td>11:</td> <td>12:</td> <td>13:</td> <td>14:</td> <td>15:</td> </tr> <tr> <td>16:</td> <td>17:</td> <td>18:</td> <td>19:</td> <td>20:</td> </tr> </table> <p>Enter the Extension Number</p> <p style="text-align: center;">: = *</p>	1:	2:	3:	4:	5:	6:	7:	8:	9:	10:	11:	12:	13:	14:	15:	16:	17:	18:	19:	20:
1:	2:	3:	4:	5:																
6:	7:	8:	9:	10:																
11:	12:	13:	14:	15:																
16:	17:	18:	19:	20:																

Parameter	Value Range (default)	Description/Function	Reference
Extension Group List No.	2–5 digits (None)	Specifies any vacant extension number. [Note] Extension Group List No. can be assigned as “The Extension of the Owner” of a mailbox so that all group members can share the information in the same mailbox. In this case, each group member cannot have another mailbox.	Extension Group p.3-22 The Extension of the Owner p.4-21
Group Name	Up to 16 characters	For your reference.	
Member (1–20)	2–5 digits (None)	Specifies extension numbers belonging to this group. [Note] If a mailbox is owned by an extension group, each member cannot have another mailbox.	

4.5.5 System Parameter Settings

Extension Group – Delete

You can specify extensions to be deleted from the list.

System Administration Top Menu → 1 → 5 → 1 → 2 → 2 → Group List No.

Program – System Parameter – System Group Assignment – Extension – Delete

GROUP No. [XXX]

Extension Group Name _____ : EXTENSION GROUP

1:	2:	3:	4:	5:
6:	7:	8:	9:	10:
11:	12:	13:	14:	15:
16:	17:	18:	19:	20:

Enter the Number You Want to Delete

: = *

Extension Group – Listing

This displays all Extension Group List numbers.

System Administration Top Menu → 1 → 5 → 1 → 2 → 3 → Group List No.

Program – System Parameter – System Group Assignment – Extension – Group Listing

1: 12345	Ext Group Name 1	11:
2: 11111	Ext Group Name 2	12:
3:		13:
4:		14:
5:		15:
6:		16:
7:		17:
8:		18:
9:		19:
10:		20:

4.5.5.2 Day Service

Day service is a timer function that provides the appropriate way of incoming calls handling a specified time of day.

The following items can be programmed differently between day mode and night mode.

Port Assignment (See page 4-37) / **Operator's Parameters** (See page 4-41)

4.5.5 System Parameter Settings

System Administration Top Menu → 1 → 5 → 2

Program – System Parameter – Day Service			
	Start Time		End Time
MON :	9:00, AM	→	5:00, PM
TUE :	9:00, AM	→	5:00, PM
WED :	9:00, AM	→	5:00, PM
THU :	9:00, AM	→	5:00, PM
FRI :	9:00, AM	→	5:00, PM
SAT :	9:00, AM	→	5:00, PM
SUN :	9:00, AM	→	5:00, PM

D: Day Mode N: Night Mode

Parameter	Value Range (default)	Description/Function	Reference
MON (Start/End) SUN (Start/End)	1–12: hour 00–59: minute AM/PM:a.m./p.m. D: Day Mode N: Night Mode MON–SUN (9:00 AM 5:00 PM)	Specifies “Start” and “End” time of the Day service. Day Mode: 24 hours Day mode Night Mode: 24 hours Night mode	Day Service p.3-19

4.5.5.3 Holiday Setting

You can program a special service mode for up to 20 holidays. The VPS will provide the specified incoming call service and company greetings according to the day service setting of the holiday. If a day is set as a holiday, the starting and ending time specified in the Day service is ignored.

System Administration Top Menu → 1 → 5 → 3

Program – System Parameter – Holiday Setting Menu	
1. Holiday Setting Enter	
2. Holiday Setting Delete	
3. Holiday Listing	
<u>SELECT ITEM AND PRESS RETURN-KEY</u>	

4.5.5 System Parameter Settings

Holiday Setting – Enter

System Administration Top Menu → 1 → 5 → 3 → 1

Program – System Parameter – Holiday Setting – Enter Menu

1: No Holiday Name	11: No Holiday Name
2: No Holiday Name	12: No Holiday Name
3: No Holiday Name	13: No Holiday Name
4: No Holiday Name	14: No Holiday Name
5: No Holiday Name	15: No Holiday Name
6: No Holiday Name	16: No Holiday Name
7: No Holiday Name	17: No Holiday Name
8: No Holiday Name	18: No Holiday Name
9: No Holiday Name	19: No Holiday Name
10: No Holiday Name	20: No Holiday Name

Enter the Holiday Number (1-20) : = *

System Administration Top Menu → 1 → 5 → 3 → 1 → Holiday No. (1-20)

Program – System Parameter – Holiday Setting – Enter – Holiday 1

Holiday Number [1]

Name of Holiday _____ :
 Date _____ : MM/DD
 Retain Holiday _____ : No
 Service _____ : Auto. Attn.
 Company Greeting Number (1-32) _____ :
 Port Affected (1, 2, 3, 4) _____ : 1, 2, 3, 4

Parameter	Value Range (default)	Description/Function	Reference
Name of Holiday	Up to 16 characters (None)	For your reference.	Holiday Service p.3-26
Date	MM : Month DD : Day (None)	Specifies the date of holiday.	
Retain Holiday	1. Yes 2. No (No)	Used to keep the Holiday service setting for future use. If set to "Yes", the same setting will be activated automatically on the same day every year. If set to "No", the setting will be canceled automatically after the holiday is over.	

4.5.5 System Parameter Settings

Parameter	Value Range (default)	Description/Function	Reference
Service	1. Voice Mail 2. Auto. Attn. 3. Interview 4. Custom (Auto. Attn.)	Specifies one of four incoming call services for the holiday. [Notes] • When you specify the Interview service, one of Subscriber's mailbox numbers should also be specified. • When you specify the Custom service, one of Custom service numbers (1-100) should also be specified.	
Company Greeting Number	1-32 (None)	Specifies a company greeting number (1-32) as a holiday greeting.	Company Greetings p.3-12
Port Affected	Port No. (1, 2, 3, 4)	Specifies the port number on which you want to activate the Holiday service setting. At least one port must be specified. The unspecified port(s) provide(s) the usual incoming call service. [Note] The value range depends upon the models.	Port Service p.3-49

Holiday Setting – Delete

You can cancel the Holiday service setting by specifying a holiday number (1-20).

System Administration Top Menu → 1 → 5 → 3 → 2

Program – System Parameter – Holiday Setting – Delete Menu	
1: No Holiday Name	11: No Holiday Name
2: No Holiday Name	12: No Holiday Name
3: No Holiday Name	13: No Holiday Name
4: No Holiday Name	14: No Holiday Name
5: No Holiday Name	15: No Holiday Name
6: No Holiday Name	16: No Holiday Name
7: No Holiday Name	17: No Holiday Name
8: No Holiday Name	18: No Holiday Name
9: No Holiday Name	19: No Holiday Name
10: No Holiday Name	20: No Holiday Name
Enter the Holiday Number (1-20) : = *	

4.5.5 System Parameter Settings

Holiday Setting – Listing

Used to display all the specified holiday names and dates.

System Administration Top Menu → 1 → 5 → 3 → 3

Program – System Parameter – Holiday Setting – Holiday Listing	
1: No Holiday Name	11: No Holiday Name
2: No Holiday Name	12: No Holiday Name
3: No Holiday Name	13: No Holiday Name
4: No Holiday Name	14: No Holiday Name
5: No Holiday Name	15: No Holiday Name
6: No Holiday Name	16: No Holiday Name
7: No Holiday Name	17: No Holiday Name
8: No Holiday Name	18: No Holiday Name
9: No Holiday Name	19: No Holiday Name
10: No Holiday Name	20: No Holiday Name

4.5.5.4 Daylight Saving Time

Used to adjust the internal clock for the starting date and ending date of the daylight saving time.

System Administration Top Menu → 1 → 5 → 4

Program – System Parameter – Daylight Saving Time Menu	
Start Date (1 hour forward) (MM/DD) _____	: MM/DD
End Date (1 hour back) (MM/DD) _____	: MM/DD

Parameter	Value Range (default)	Description/Function	Reference
Start Date/ End Date	MM : Month DD : Day (None)	Specifies the starting and ending dates of daylight saving time. The VPS advances one hour on the starting date of daylight saving time, and restores the time on the ending date. Both the starting date and the ending date must be set and the same date cannot be set in both settings.	Daylight Saving Time Assignment p.3-19

4.5.5 System Parameter Settings

4.5.5.5 Prompt Setting

This setting is required when Multi-Lingual service.

System Administration Top Menu → 1 → 5 → 5

Program – System Parameter – Prompt Setting Menu	
System Prompt Selection Number (1-9) _____	:
User 1 Prompt Selection Number (1-9) _____	:
User 2 Prompt Selection Number (1-9) _____	:
Position of "AM/PM" in Time Stamp _____	: After

Parameter	Value Range (default)	Description/Function	Reference
System Prompt Selection Number	1-9 (None)	Pressing one of these numbers from the language selection menu enables the caller or the receiver of an external delivery message to select a language of voice prompts. This setting is required when either one or both of the following parameters are set to "Selective". <ul style="list-style-type: none"> • Port Assignment – Incoming Call Service Prompt • Authorization of External Message Delivery – Prompt Mode Example: <div style="border: 1px solid black; padding: 5px; margin: 5px 0;"> <i>For service in English, press [7]. For service in Spanish, press [8]. For service in Chinese, press [9].</i> </div> This message can be recorded by the Message Manager. [Note] Prompt selection numbers and the first digit of the mailbox numbers should be different from each other.	Multi-Lingual Service p.3-42 Voice Prompts p.3-58 Prompt Mode p.4-34 Incoming Call Service Prompt p.4-38 Recording Selection Menus p.6-16
User 1 Prompt Selection Number			
User 2 Prompt Selection Number			

4.5.5 System Parameter Settings

Parameter	Value Range (default)	Description/Function	Reference
Position of "AM/PM" in Time Stamp	1. Before 2. After 3. None (After)	Specifies the time notation. 1. Before The VPS announces "AM/PM" before the time (e.g., A.M. 3:42). 2. After The VPS announces "AM/PM" after the time (e.g., 3:42 A.M.). 3. None The VPS does not announce "AM/PM" (e.g., 3:42).	Multi-Lingual Service p.3-42 Message Scan p.3-37

4.5.5.6 Other Parameters

System Administration Top Menu → 1 → 5 → 6

<p>Program – System Parameter – Others Menu</p> <ol style="list-style-type: none"> 1. Extension Numbering Plan 2. Dialing Parameter 3. Message Waiting Notification 4. External Message Delivery 5. Call Hold 6. Rotary Telephone Service 7. Intercom Paging Parameter 8. FAX Management 9. Disconnect Parameter <p><u>SELECT ITEM AND PRESS RETURN-KEY</u></p>
--

4.5.5.6.1 Extension Numbering Plan

Used to specify the extension numbers of your PBX so that the VPS can recognize the dialed extension number as a valid one.

4.5.5 System Parameter Settings

System Administration Top Menu → 1 → 5 → 6 → 1

Program – System Parameter – Others – Extension Numbering Plan Menu	
Numbering Plan 1 _____	: 2XX ...
Numbering Plan 2 _____	: 3XX ...
Numbering Plan 3 _____	:
Numbering Plan 4 _____	:
Numbering Plan 5 _____	:
Numbering Plan 6 _____	:
Numbering Plan 7 _____	:
Numbering Plan 8 _____	:
Numbering Plan 9 _____	:
Numbering Plan 10 _____	:
Numbering Plan 11 _____	:
Numbering Plan 12 _____	:
Numbering Plan 13 _____	:
Numbering Plan 14 _____	:
Numbering Plan 15 _____	:
Numbering Plan 16 _____	:

Parameter	Value Range (default)	Description/Function	Reference
Numbering Plan 1-16	2-5 digits consisting of 0-9, X (2XX,3XX)	<p>Specifies the first one or two digits of the extension number of your PBX. Up to 16 entries can be registered in the list. Each entry contains 2-5 digits of numeric characters '0-9' and 'X' which matches any digit. Extension numbers cannot begin with '0'.</p> <p>Examples:</p> <p>(a) If valid extension numbers of your PBX are 101 through 164 and 201 through 264, specify the numbers as follows:</p> <p>1XX: Indicates any three-digit extension number starting with '1'. 2XX: Indicates any three-digit extension number starting with '2'.</p> <p>(b) If valid extension numbers of your PBX are 400 through 450 and 3300 through 3399, specify the numbers as follows:</p> <p>4XX: Indicates any three-digit extension number starting with '4'. 33XX: Indicates any four-digit extension number starting with '33'.</p>	Extension Numbering Plan p.3-22

4.5.5 System Parameter Settings

4.5.5.6.2 Dialing Parameters

System Administration Top Menu → 1 → 5 → 6 → 2

Program – System Parameter – Others – Dialing Parameter Menu	
Number of Digits to Access Outside Line (0-8 digits) —	: 1
Call Transfer No-answer Time (10-60 sec) —————	: 20
Outgoing Call No-answer Time (10-90 sec) —————	: 30
Pause Time —————	: 2
Outgoing Call Setup Sequence —————	: T

Parameter	Value Range (default)	Description/Function	Reference
Number of Digit to Access Outside Line	0–8 digits (1)	<p>Specifies the number of digits required to access an outside line.</p> <p>Example: If the PBX requires callers to dial '9' in order to access an outside line, this parameter should be set to 1 digit. This causes the system to be aware that, when dialing the number 9–123–4567 for example, outgoing call setup sequence is done after the initial '9' is dialed. The full sequence is therefore: 9– [outgoing call setup sequence] –123–4567.</p> <p>For periodic port usage reports, the VPS can discriminate between local and long distance calls and can report outgoing calls and calling times for billing purpose.</p>	<p>Outgoing Call Setup Sequence p.4-66</p> <p>Port Usage Report p.7-18</p>
Call Transfer No-answer Time	10–60 sec (20)	Specifies the amount of time that the VPS should wait before receiving the transferred call if there is no answer at the destination extension.	Call Transfer Status p.3-10
Outgoing Call No-answer Time	10–90 sec (30)	Specifies the amount of time that the VPS should wait before concluding that the outgoing call will not be answered.	E.M.D. Service p.3-22
Pause Time	1–9 sec (2)	Specifies the pause duration which is used at the time of entering telephone numbers in the VPS. It is a pause time between dialed digits.	M.W.N.-Device p.3-38

4.5.5 System Parameter Settings

Parameter	Value Range (default)	Description/Function	Reference
Outgoing Call Setup Sequence	Up to 12 digits consisting of 0-9, *, #, F, R, S, T, W (T)	<p>Specifies the sequence of codes used by the VPS to make a call to an outside line. You can set up to 12 digits. The default value is 'T', which means that the VPS dials the outside phone numbers after detecting dial tone.</p> <p>Example: 9T = [9] → Dial Tone Detection → dial outside phone number. '9' is the CO line access number.</p> <div style="border: 1px solid black; padding: 5px;"> <p>D : Disconnecting F : Hook Flash R : Ring Back Tone Detection S : Silence Detection T : Dial Tone Detection W : Wait for 1 second 1-9, 0, *, # : Dial Codes</p> </div>	E.M.D. Service p.3-22 M.W.N. Device p.3-38

4.5.5.6.3 Message Waiting Notification

The following parameters are used to control the handling of message notification calls.

System Administration Top Menu → 1 → 5 → 6 → 3

Program - System Parameter - Others - Message Waiting Notification Menu	
Outgoing Call Ports _____	: 1, 2, 3, 4
Message Waiting Lamp Ports _____	: 1, 2, 3, 4
Message Waiting Lamp for Every Message _____	: No
Max. Digits for Callback No. (1-48 digits) _____	: 20
Callback No. Entry Interdigit Time-Out (1-10 sec) _____	: 5
System Callback No. _____	:
	:

4.5.5 System Parameter Settings

Parameter	Value Range (default)	Description/Function	Reference
Outgoing Call Ports	Port No. (1, 2, 3, 4)	Specifies the port numbers used for the Message Waiting Notification-Device feature. The VPS makes outgoing calls using a port specified in this field. At least one port must be specified.	Number to Dial p.4-23
Message Waiting Lamp Ports	Port No. (1, 2, 3, 4)	Specifies the port numbers used for the Message Waiting Notification-Lamp feature. The VPS turns on the message waiting lamp of the extension using a port specified in this field. At least one port must be specified.	M.W.N.-Lamp p.3-41
Message Waiting Lamp for Every Message	1. Yes 2. No (No)	If set to "Yes", the VPS will turn on the message waiting lamp of the extension every time a new message is recorded in the mailbox even if the message waiting lamp has not been turned off from a previous message. If set to "No", the VPS will turn on the message waiting lamp for only the first message. It will not notify subsequent messages until the Subscriber has accessed the VPS to receive the message. This setting is useful if the first attempt has unsuccessful for some reason.	
Max. Digits for Callback No.	1-48 digits (20)	Specifies the maximum number of digits the caller can enter as a callback number. This number will be displayed on beepers if "Beeper Callback No. Entry Mode" is activated.	Callback Number Entry p.3-7
Callback No. Entry Interdigit Time-Out	1-10 sec (5)	Sets the maximum time allowed between each digit on Beeper Callback No. Entry. If the caller does not enter any digits within this length of time following the last digit entry, the VPS considers it as the end of entry and does not accept additional entry.	Number to Dial p.4-23 Type p.4-24 Beeper Callback No. Entry Mode p.4-33
System Callback No.	Up to 32 digits (None)	Specifies a telephone number displayed on Subscriber's beepers as a callback number when "Type" is set to "Beeper". [Note] If "Beeper Callback No. Entry Mode" is activated, the callback number entered by the caller will be displayed on the destination beeper instead of this system callback number.	

4.5.5 System Parameter Settings

4.5.5.6.4 External Message Delivery Parameters

Used to control the handling of External Message Delivery calls.

System Administration Top Menu → 1 → 5 → 6 → 4

Program – System Parameter – Others – External Message Delivery Menu	
Retry Times (0-4 times) _____	: 3
Busy Delay (2-60 min.) _____	: 3
No-answer Delay (2-120 min.) _____	: 60
Outgoing Call Ports _____	: 1, 2, 3, 4
Message Length (1-6 min.) _____	: 3
Max. Message for Mailboxes (1-100 msg) _____	: 3
System External Message Delivery Duration Time (1-9 min.) —	: 3
Company's Telephone No. _____	:
	:

Parameter	Value Range (default)	Description/Function	Reference
Retry Times	0-4 times (3)	Specifies the number of times that an external message delivery call should be attempted when the destination is busy or if there is no answer.	E.M.D. Service p.3-22
Busy Delay	2-60 min. (3)	Specifies the length of time in minutes the VPS is to wait after a busy condition before trying to deliver the message again.	
No-answer Delay	2-120 min. (60)	Specifies the length of time in minutes the VPS is to wait after a no answer condition before trying to deliver the message again.	
Outgoing Call Ports	Port No. (1, 2, 3, 4)	Specifies the port numbers used for the External Message Delivery feature.	
Message Length	1-6 min. (3)	Specifies the allowable length of external delivery messages that the Subscriber can record in his own mailbox.	
Max. Messages for Mailboxes	1-100 messages (3)	Specifies the maximum number of external delivery messages which can be held in one mailbox at a time.	

4.5.5 System Parameter Settings

Parameter	Value Range (default)	Description/Function	Reference
System External Message Delivery Duration Time	1-9 min. (3)	Specifies the maximum telephone connect time allowable for an external message delivery call. Used to prevent excessive telephone charges. This time starts when the destination of the external delivery message answers the call. The VPS terminates the call (after playing a prompt) when the specified length of time is exceeded.	E.M.D. Service p.3-22
Company's Telephone No.	Up to 32 digits	This telephone number is announced in the callback message to the recipient as the telephone number he should call to retrieve the sender's message. The VPS plays the callback message to recipients if the person answering the call was unable to enter the correct password and could not receive the message.	

4.5.5 System Parameter Settings

4.5.5.6.5 Call Hold Parameters

System Administration Top Menu → 1 → 5 → 6 → 5

Programming – System Parameter – Others – Call Hold Menu

Call Hold Mode _____ : Enable
 Call Queuing Announcement Mode _____ : Enable
 Call Retrieval Announcement Timing (1-30 sec) _____ : 2
 Redialing Cancel Timing _____ : 30

Parameter	Value Range (default)	Description/Function	Reference
Call Hold Mode	1. Disable 2. Enable (Enable)	If set to "Enable", the caller can hold the call or take an Incomplete Call Handling service option. For example, leaving a message when the called extension is busy. While on hold, the VPS asks the caller repeatedly whether he wishes to continue the hold or take an Incomplete Call Handling service option. If set to "Disable", the VPS offers callers Incomplete Call Handling service immediately.	Hold p.3-26 Incomplete Call Handling Service p.3-29
Call Queuing Announcement Mode	1. Disable 2. Enable (Enable)	If set to "Enable", callers on hold are informed of their current position in the call hold queue. Example: <i>Sorry, two other people are waiting to connect.</i>	
Call Retrieval Announcement Timing	1-30 sec (2)	Specifies how long the VPS should wait before asking the caller whether he wishes to keep holding or retrieve the call to take an Incomplete Call Handling service. Example: <i>Redialing now, please wait a moment. To retrieve the call, press [2].</i>	
Redialing Cancel Timing	1. 15 sec 2. 30 sec 3. 45 sec 4. 60 sec (30)	Specifies how long the VPS should wait before asking the caller whether to redial. Example: <i>To continue redialing, press [1].</i>	

4.5.5 System Parameter Settings

4.5.5.6.6 Rotary Telephone Service

Used to define the treatment of callers who are calling from a rotary telephone (unable to input DTMF signals) or callers who cannot properly respond to the guidance of the VPS in the Voice Mail service.

System Administration Top Menu → 1 → 5 → 6 → 6

Program – System Parameter – Others – Rotary Telephone Service Menu
Rotary Telephone Call Coverage Day Mode ----- : G.D.M.
Rotary Telephone Call Coverage Night Mode----- : G.D.M.

Parameter	Value Range (default)	Description/Function	Reference
Rotary Telephone Call Coverage (Day), (Night)	1. G.D.M. 2. OPERATOR EXTENSION (G.D.M.)	Defines how the VPS treats callers who are calling from a rotary telephone or callers who are unfamiliar with the VPS operation. [Note] G.D.M. = General Delivery Mailbox	Operator Service p.3-46 Rotary Telephone Service p.3-52

4.5.5.6.7 Intercom Paging Parameter

Intercom Paging is a PBX feature which makes it possible to page a caller's desired party through built-in speakers of proprietary telephones.

To utilize this feature, the Intercom Paging feature must be available on your PBX and the following parameters are properly programmed to meet the requirements of your PBX.

Note: This feature is available if D-PITS Voice Mail Integration with a Panasonic KX-TD series telephone system is activated.

4.5.5 System Parameter Settings

System Administration Top Menu → 1 → 5 → 6 → 7

Program – System Parameter – Others – Intercom Paging Parameter Menu

Intercom Paging Sequence _____ :

Release for Intercom Paging _____ :

No-answer Time for Intercom Paging (1-30 sec) _____ : 5

Announcement Repeat Cycle (1-3 times) _____ : 1

Intercom Paging Retry (1-10 times) _____ : 2

Paging Code for Group 1 _____ :

Paging Code for Group 2 _____ :

Paging Code for Group 3 _____ :

Paging Code for Group 4 _____ :

Paging Code for Group 5 _____ :

Paging Code for Group 6 _____ :

Paging Code for Group 7 _____ :

Paging Code for Group 8 _____ :

Parameter	Value Range (default)	Description/Function	Reference
Intercom Paging Sequence	Up to 12 digits consisting of 0-9, *, # and special codes (None)	Specifies the intercom paging sequence required by your PBX. Use up to 12 of the following eight letters and twelve dial codes. <div style="border: 1px solid black; padding: 5px; margin: 5px 0;"> D : Disconnecting F : Hook Flash R : Ring Back Tone Detection S : Silence Detection T : Dial Tone Detection W : Wait for 1 second X : Pager Dialing A : Answer 1-9, 0, *, # : Dial Codes </div>	Incomplete Call Handling Service p.3-29 Intercom Paging P.3-30
Release for Intercom Paging	Up to 12 digits consisting of 0-9, *, # and special codes (None)	Specifies the intercom paging release code required by your PBX. Up to 12 alphanumeric characters can be set using the same letters and dial codes as the Intercom Paging sequence.	
No-answer Time for Intercom Paging	1-30 sec (5)	Specifies the length of time in seconds that the VPS should wait before terminating the Intercom Paging because there is no answer. The VPS goes back to the caller if the paged party does not respond before this timer expires.	

4.5.5 System Parameter Settings

Parameter	Value Range (default)	Description/Function	Reference
Announcement Repeat Cycle	1-3 times (1)	Specifies the number of times that the intercom paging announcement should be repeated. Example: <i>There is a call for <mailbox owner's name>.</i>	
Intercom Paging Retry	1-10 times (2)	Specifies the paging retry times when the paged destination is busy or if there is no answer.	
Paging Code for Group 1-8	Up to 12 numeric characters for each group (None)	Specifies the intercom paging access code required by the PBX. [Note] Intercom paging group number available for each Subscriber is determined on a COS-by-COS basis.	Intercom Paging Group p.4-30

4.5.5.6.8 Fax Management

Transfers incoming fax calls to a fax extension.

Up to two fax extensions can be specified as the destinations of automatic fax transfer so that one serves as a backup for the other.

If the main fax extension is not available to receive a fax call, the VPS will transfer it to the alternate fax extension.

System Administration Top Menu → 1 → 5 → 6 → 8

Program – System Parameter – Others – Fax Management Menu	
Automatic Transfer of Incoming Fax Call	: Disable
Main Fax Extension No.	: ...
Alternate Fax Extension No.	: ...
Fax No-answer Time (5-60 sec)	: 10
Fax Manager Mailbox No.	: ...
Fax No-answer Coverage Mode	: No
Fax Notification Mode	: No

4.5.5 System Parameter Settings

Parameter	Value Range (default)	Description/Function	Reference
Automatic Transfer of Incoming Fax Call	1: Disable 2: Enable (Disable)	Activates or deactivates the automatic transfer of Fax Management service.	Fax Management p.3-24
Main Fax Extension No.	2-5 digits (None)	Specifies a fax extension number which serves as the main fax.	
Alternate Fax Extension No.	2-5 digits (None)	Specifies a fax extension number which serves as the backup for the main fax extension. When the main fax extension is busy or if there is no answer within "Fax No-answer Time", the VPS will transfer a fax call to this extension.	
Fax No-answer Time	5-60 sec (10)	Specifies the length of time in seconds the VPS is to wait before taking another action if there is no answer. [Note] This timer applies to the fax call which has been transferred to the main fax or alternate fax extension.	
Fax Manager Mailbox No.	2-5 digits (None)	Specifies the mailbox number of the Fax Manager to which the VPS will notify status of fax calls depending on "Fax No-answer Coverage Mode" and "Fax Notification Mode" settings.	
Fax No-answer Coverage Mode	1. No 2. Mbx 3. Extn. (No)	<p>If set to "Mbx", the VPS will leave the number of unanswered fax calls in the Fax Manager's mailbox.</p> <p>Example:</p> <div style="border: 1px solid black; padding: 5px; margin: 10px 0;"> <p><i>The FAX transfer situation is as follows. One attempt was no answer.</i></p> </div> <p>If set to "Extn.", the VPS will call the Fax Manager's extension to inform the number of unanswered fax calls. The VPS will also leave the number of unanswered fax calls in the Fax Manager's mailbox.</p> <p>If set to "No", the VPS does not take any action on unanswered fax calls.</p>	

4.5.5 System Parameter Settings

Parameter	Value Range (default)	Description/Function	Reference
Fax Notification Mode	1. No 2. Mbx 3. Extn. (No)	<p>If set to "Mbx", the VPS will leave the number of successfully-received fax calls in the Fax Manager's mailbox.</p> <p>Example:</p> <div style="border: 1px solid black; padding: 5px; margin: 10px 0;"> <p><i>You have one FAX message.</i></p> </div> <p>If set to "Extn.", after a fax extension receives a fax call successfully, the VPS automatically calls the Fax Manager's extension and plays a voice prompt, such as, "You have one FAX message". The VPS will also leave the number of received fax calls in the Fax Manager's mailbox.</p> <p>If set to "No", the VPS does not take any action on successfully-received fax calls.</p>	Fax Management p.3-24

4.5.5.6.9 Disconnect Parameter

System Administration Top Menu → 1 → 5 → 6 → 9

Programming – System Parameter – Others – Disconnect Parameter Menu Maximum Silence Time (5-60 sec) _____ :- 10
--

Parameter	Value Range (default)	Description/Function	Reference
Maximum Silence Time	5-60 sec (10)	If silence continues for more than a specified period of time, the VPS disconnects the call.	Record Message p.3-50

4.5.6 Hardware Settings

For system administration (system setup, mailbox setup, and system diagnosis), a RS-232C terminal must be connected to the serial interface of the VPS.

System Administration Top Menu → 1 → 6

<p>Program – Hardware Menu</p> <ol style="list-style-type: none"> 1. RS-232C 2. Port Setting 3. PBX Interface Parameters <p style="text-align: center;"><u>SELECT ITEM AND PRESS RETURN-KEY</u></p>
--

4.5.6.1 RS-232C Parameters

System Administration Top Menu → 1 → 6 → 1

<p>Program – Hardware – RS-232C Menu</p> <p>Baud Rate _____ : 9600</p> <p>Word Bit Length _____ : 8</p> <p>Parity _____ : None</p> <p>Stop Bit Length _____ : 1</p>

Parameter	Value Range (default)	Description/Function	Reference
Baud Rate	<ol style="list-style-type: none"> 1. 300 b.p.s 2. 600 b.p.s 3. 1200 b.p.s 4. 2400 b.p.s 5. 4800 b.p.s 6. 9600 b.p.s 7. 19200 b.p.s (9600) 	Specifies the speed at which the data is transferred (bits per second).	Data Terminal or Printer Connection p.2-15
Word Bit Length	<ol style="list-style-type: none"> 1. 7 bits 2. 8 bits (8) 	Defines the number of bits in each byte or character.	
Parity	<ol style="list-style-type: none"> 1. None 2. Odd 3. Even (None) 	Specifies the kind of parity used for error detection.	

4.5.6 Hardware Settings

Parameter	Value Range (default)	Description/Function	Reference
Stop Bit Length	1. 1 bit 2. 2 bits (1)	Specifies the number of bits used to signify the end of the byte.	Data Terminal or Printer Connection p.2-15

4.5.6.2 Port Setting

The VPS must be connected to a PBX telephone line port before system start up.

System Administration Top Menu → 1 → 6 → 2

<p>Program – Hardware – Port Setting Menu</p> <ol style="list-style-type: none"> 1. Port 1 2. Port 2 3. Port 3 4. Port 4 <p><u>SELECT ITEM AND PRESS RETURN-KEY</u></p>

Port Setting Menu

System Administration Top Menu → 1 → 6 → 2 → 1

<p>Program – Hardware – Port Setting – Port 1 Menu</p> <p>Flash Time ----- : 100 CPC Signal ----- : 6.5 Disconnect Time ----- : 2 Dial Mode ----- : DTMF</p>

Parameter	Value Range (default)	Description/Function	Reference
Flash Time	1. 100 msec 2. 300 msec 3. 600 msec 4. 900 msec (100)	Specifies the length of time that the hookswitch must be pressed before the PBX recognizes it as a flash hook signal. See the manuals of PBX to determine the correct value. [NOTE] You can select only "1. 100 msec".	PBX Type p.4-79

Note: The "Flash" means the register recall in this manual.

4.5.6 Hardware Settings

Parameter	Value Range (default)	Description/Function	Reference
CPC Signal	1. None 2. 6.5 msec 3. 150 msec 4. 300 msec 5. 450 msec 6. 600 msec (6.5)	Specifies the minimum time required to detect a break in the CPC (Calling Party Control) signal from the PBX. The VPS detects that the line has been disconnected when there is a break of the CPC signal.	PBX Type p.4-79
Disconnect Time	1-8 sec (2)	Specifies the amount of time that the line is temporarily unavailable to access after a call has ended.	
Dial Mode	1. DTMF 2. Pulse 10 pps 3. Pulse 20 pps (DTMF)	Specifies dial mode for DTMF or Pulse. If you specify Pulse, pulse speed (10/20 pps) must be selected. [NOTE] You can not select "3. Pulse 20 pps".	

4.5.6.3 PBX Interface Parameters

Three types of parameters are used to program the VPS for optimal signaling and performance with your PBX.

System Administration Top Menu → 1 → 6 → 3

<p>Program - Hardware - PBX Interface Menu</p> <ol style="list-style-type: none"> 1. Dialing Parameters 2. Inband Signaling 3. Digit Translation Table <p><u>SELECT ITEM AND PRESS RETURN-KEY</u></p>
--

4.5.6.3.1 Dialing Parameters

These parameters tell the VPS how to initiate and control call transfers, how to set up outgoing calls and how to control message waiting lamps on extensions. The easiest way to verify the correct code sequences for non-Panasonic KX-T series telephone systems is to manually execute the sequences from a single line telephone (SLT) with your PBX.

4.5.6 Hardware Settings

System Administration Top Menu → 1 → 6 → 3 → 1

Program – Hardware – PBX Interface – Dialing Parameters Menu	
PBX Type	: Other
Integration Mode	: None
Operator Transfer Sequence	: FX
Extension Transfer Sequence	: FX
Alternate Extension Transfer Sequence	: FX
Reconnect Sequence on Busy	: FWW
Reconnect Sequence on No-answer	: FWW
Reconnect Sequence on Refuse Call	: FWW
Light-On Sequence for Message Waiting Lamp	:
Light-Off Sequence for Message Waiting Lamp	:
Call Waiting Sequence	:
Release for Call Waiting	:

Parameter	Value Range (default)	Description/Function	Reference
PBX Type	1. Other Manufactures 2. KX-T Series 1. T308 2. T616 3. T1232 4. T96 5. T336 6. TD816 7. TD1232 (Other)	Specifies a type of PBX which is connected to the VPS. In the case of a Panasonic KX-T series telephone system, the model number should also be specified. [Note] After selecting the PBX Type, the rest of the Dialing Parameters are set automatically to each PBX default values. Refer to the table on next page.	Quick Setup p.4-8

4.5.6 Hardware Settings

* When your KX-TD series telephone system is in D-PITS Integration mode

PBX Type	Other Manufacturers	KX-T series								
		T308	T616	T1232	T96	T336	TD816		TD1232	
Integration Mode	None	None	None	Inband	Inband	Inband	None	* D-PITS	None	* D-PITS
							Inband		Inband	
Operator Transfer Sequence	FX	FTX	FTX	FTX	FTX	FTX	FTX	FX	FTX	FX
Extension Transfer Sequence	FX	FTX	FTX	FTX	FTX	FTX	FTX	FX	FTX	FX
Alternate Extension Transfer Sequence	FX	FTX	FTX	FTX	FTX	FTX	FTX	FX	FTX	FX
Reconnect Sequence on Busy	FWW	FWW	FWW	FWW	FWW	FWW	FWW	F	FWW	F
Reconnect Sequence on No-Answer	FWW	FWW	FWW	FWW	FWW	FWW	FWW	F	FWW	F
Reconnect Sequence on Refuse Call	FWW	FWW	FWW	FWW	FWW	FWW	FWW	F	FWW	F
Light-On Sequence for Message Waiting Lamp	None	N/A	N/A	T701X#	T#91X	T*9X	T701X	—	T701X	—
Light-Off Sequence for Message Waiting Lamp	None	N/A	N/A	T702X#	T#90X	T#9X	T700X	—	T700X	—
Call Waiting Sequence	None	N/A	N/A	2	N/A	N/A	2	2	2	2
Release Sequence for Call Waiting	None	N/A	N/A	F	N/A	N/A	F	F	F	F

N/A : Not available — : Not needed

4.5.6 Hardware Settings

Parameter	Value Range (default)	Description/Function	Reference
Integration Mode	1. None 2. Inband 3. D-PITS (None)	<p>Specifies methods of integrating VPS with your PBX.</p> <ol style="list-style-type: none"> None Both PBX and VPS work independently. No information is provided concerning the status of the other system. Inband The PBX sends DTMF tone codes to the VPS which indicate the state of the call (busy, answered, disconnected, etc.). The Inband integration enables the VPS to recognize the call transfer status faster. The PBX codes that indicate the status of calls must be defined. If you have set the PBX type to a KX-T series telephone system, these codes will automatically default to proper codes. This is available when the VPS works with one of the following Panasonic KX-T series telephone systems: T 1232, T96, T336, TD816, TD1232 D-PITS The VPS communicates with the PBX via D-PITS interface. This is available when the VPS works with one of the following Panasonic KX-TD series telephone systems: TD816, TD1232. 	D-PITS p.3-21 Inband p3-26 PBX Integration p.3-47 Inband Signaling Parameters p.4-83

To program the 10 parameters on the next page, use Special Commands and Dial Codes listed below. Up to 12 digits can be set for each parameter.

D : Disconnecting
 F : Hook Flash
 R : Ring Back Tone Detection
 S : Silence Detection
 T : Dial Tone Detection
 W : Wait for 1 second
 X : Extension Dialing
 A : Answer
 1-9, 0, *, # : Dial Codes

4.5.6 Hardware Settings

Parameter	Value Range (default)	Description/Function	Reference
Operator Transfer Sequence	(FX)	Used to transfer calls to the operator's extension.	A.A.Service p.3-4 Operator Service p.3-46
Extension Transfer Sequence	(FX)	Used to transfer calls to any extension other than the operator's.	Call Transfer Status p.3-10
Alternate Extension Transfer Sequence	(FX)	Used to transfer calls to the extension in Alternate Extension Group.	Alternate Extension Group p.3-3
Reconnect Sequence on Busy	(FWW)	If the extension that a caller wants is busy, this sequence allows the VPS to reconnect with the caller.	Incomplete Call Handling Service p.3-29
Reconnect Sequence on No-answer	(FWW)	If the extension that a caller wants does not answer, this sequence allows the VPS to reconnect with the caller.	
Reconnect Sequence on Refuse Call	(FWW)	This sequence is carried out by the VPS to retrieve the call on hold after the extension in the Call Screening mode has refused to take the call.	Call Transfer Status p.3-10
Light-On Sequence for Message Waiting Lamp	(None)	This is the dialing sequence that the VPS must perform to turn on the message waiting lamp on an extension.	M.W.N.-Lamp p.3-41
Light-Off Sequence for Message Waiting Lamp	(None)	This is the dialing sequence that the VPS must perform to turn off the message waiting lamp on an extension.	
Call Waiting Sequence	(None)	This sequence is carried out by the VPS to perform call waiting when the extension being called is busy.	Use Call Waiting on Busy p.4-29
Release Sequence for Call Waiting	(None)	This sequence is carried out by the VPS to release call waiting.	

4.5.6 Hardware Settings

4.5.6.3.2 Inband Signaling Parameters

These parameters are used if the PBX sends DTMF tones to the VPS to indicate the state of a call (busy, answered, disconnected, etc.). The Integration mode on page 4-81 must be set to "Inband". If PBX Type is set to a KX-T series telephone system, the Inband Signaling parameters will automatically default to the proper codes.

System Administration Top Menu → 1 → 6 → 3 → 2

Program – Hardware – PBX Interface – Inband Signaling Menu	
Ringback	: 1
Busy	: 2
Reorder	: 3
DND	: 4
Answer	: 5
Forward to VM Ringing	: 6
Forward to VM Busy	: 7
Forward to Other Extension	: 8
Confirmation	: 9
Disconnect	: #9
0, 1, 2, 3, 4, 5, 6, 7, 8, 9, *, #, A, B, C, D	

Parameter	Value Range (default)	Description/Function	Reference
The following parameters can be programmed using "0-9", "*", "#", and "A-D".			
Ringback	(1)	Indicates "Ringback Tone". Sent to the VPS when the extension it dialed is ringing.	PBX Type p.4-79 Integration Mode p.4-81
Busy	(2)	Indicates "Busy Tone". Sent to the VPS when the extension it dialed is busy.	
Reorder	(3)	Indicates "Reorder Tone". Sent to the VPS if it dials an invalid extension number or if it is inadvertently connected to another VPS.	
DND	(4)	Indicates "Do Not Disturb Tone". Sent to the VPS if the dialed extension has set Do Not Disturb feature.	

4.5.6 Hardware Settings

Parameter	Value Range (default)	Description/Function	Reference
Answer	(5)	Sent to the VPS when the called extension answers the call.	PBX Type p.4-79 Integration Mode p.4-81
Forward to VM Ringing	(6)	Sent to the VPS if the called extension is forwarded to a voice mail port and that voice mail port is available to accept the call.	
Forward to VM Busy	(7)	Sent to the VPS if the called extension is forwarded to a voice mail port and that voice mail port is not available for accepting the call.	
Forward to Other Extension	(8)	Sent to the VPS if the called extension is forwarded to another, non-voice mail, extension.	
Confirmation	(9)	Sent to the VPS when it successfully dialed a message waiting lamp on or message waiting lamp off code.	
Disconnect	(#9)	Sent to the VPS when the other party goes on-hook.	

Note: Default values in the above table are for the Panasonic KX-TD1232/816 telephone system with Inband Signaling mode. These values vary depending on the settings of "PBX Type" and "Inband Integration" in PBX Interface Parameters.

Parameter	Other Manufacturers	KX-T series						
		T308	T616	T1232	T96	T336	TD816	TD1232
Ringback	N/A	N/A	N/A	1	A1	A1	1	1
Busy	N/A	N/A	N/A	2	B1	B1	2	2
Reorder	N/A	N/A	N/A	3	B2	B2	3	3
DND	N/A	N/A	N/A	4	B3	B3	4	4
Answer	N/A	N/A	N/A	5	A2	A2	5	5
Forward to VM Ringing	N/A	N/A	N/A	6	C1	C1	6	6
Forward to VM Busy	N/A	N/A	N/A	7	C2	C2	7	7

4.5.6 Hardware Settings

Parameter	Other Manufacturers	KX-T series						
		T308	T616	T1232	T96	T336	TD816	TD1232
Forward to Other Extension	N/A	N/A	N/A	8	C3	C3	8	8
Confirmation	N/A	N/A	N/A	9	D1	D1	9	9
Disconnect	N/A	N/A	N/A	#9	DD	DD	#9	#9

N/A : Not available

4.5.6.3.3 Digit Translation Table Parameters

Digit Translation Table is used to translate the Follow on ID signal from your PBX to the proper codes for the VPS.

This translation table is effective for the incoming signal only.

System Administration Top Menu → 1 → 6 → 3 → 3

<p>Program – Hardware – PBX Interface – Digit Translation Menu</p> <ol style="list-style-type: none"> 1. Inter-digit Timeout 2. Input/Output <p>SELECT ITEM AND PRESS RETURN-KEY</p>

Inter – Digit Timeout

System Administration Top Menu → 1 → 6 → 3 → 3 → 1

<p>Program – Hardware – PBX Interface – Digit Translation – Inter-dgt Timeout Menu</p> <p>Inter-digit Timeout _____ : 1 seconds</p> <p>1 sec 2 sec 3 sec 4 sec</p>

Parameter	Value Range (default)	Description/Function	Reference
Inter-digit Timeout	1–4 sec (1)	This parameter defines the entering interval of incoming signals (Follow on ID). A series of signals entered within a specified time are applied to translation by the Digit Translation Table.	PBX Type p.4-79 Integration Mode p.4-81

4.5.6 Hardware Settings

Digit Translation Table

System Administration Top Menu → 1 → 6 → 3 → 3 → 2

Program – Hardware – PBX Interface – Digit Translation – Input / Output		
	Input digit	Output digit
Table 1 : ->
Table 2 : ->
Table 3 : ->
Table 4 : ->
Table 5 : ->
Table 6 : ->
Table 7 : ->
Table 8 : ->

Enter the Number : = *

0, 1, 2, 3, 4, 5, 6, 7, 8, 9, *, #, A, B, C, D

Parameter		Value Range (default)	Description/Function	Reference
Table 1-8	Input digit	Up to 8 digits consisting of 0-9, *, #, A-D (None)	Make sure not to assign several codes to a single incoming signal. In this case, the system will take the first assignment.	PBX Type p.4-79 Integration Mode p.4-81
	Output digit			

Chapter 5

System Manager's Guide

This chapter explains what a System Manager is and provides step-by-step instructions for system maintenance tasks such as setting up mailboxes, setting COS parameters and checking system status.

Contents

5.1 System Manager's Function	5-2
5.2 Accessing the System Manager's Mailbox	5-3
5.3 Setting up Mailboxes	5-4
5.3.1 Creating and Editing a Mailbox	5-4
5.3.2 Deleting a Mailbox	5-6
5.3.3 Deleting a Mailbox Password	5-6
5.4 Setting COS (Class of Service) Parameters	5-7
5.5 Setting the System Clock	5-11
5.6 Checking System Usage (System Reports)	5-12
5.6.1 Obtaining System Reports	5-12
5.6.2 Clearing the Reports	5-13
5.7 Delivering Messages	5-14
5.7.1 Delivering Messages to All Mailboxes (Broadcasting Messages)	5-14
5.7.2 Delivering Messages to Specified Mailboxes.....	5-14
5.7.3 Checking Mailbox Distribution	5-15
5.8 Customizing the System Manager's Mailbox	5-16
5.9 Listening to Messages.....	5-17

5.1 System Manager's Function

As System Manager, you perform one of the most important jobs. You are in charge of coordinating the VPS to ensure that it operates efficiently and effectively. You can perform a whole range of functions using any touch-tone telephone anywhere in the world. These include daily maintenance, the creation and editing of mailboxes in response to requests from Subscribers, and the deletion of unneeded mailboxes to prevent the system's storage capacity from being exceeded. In addition to the above, you will have to set up a special password for yourself to prevent unauthorized access to System Manager commands. You will also have your own mailbox number, set to either 99, 999, 9999 or 99999 (these default values can be changed), through which Subscribers will be able to contact you.

Before starting system management

Use the **Worksheets** provided to record the information you will need to manage the system. Just fill in the blanks with the information requested. Once you have finished filling out the Worksheets, you can use them as quick reference cards to aid you in system management.

5.2 Accessing the System Manager's Mailbox

Every job of the System Manager gets started by accessing the System Manager's mailbox. To access that mailbox, you will need the following information beforehand.

System Manager's Mailbox Number

It has been assigned as '99', '999', '9999' or '99999'. It depends upon the mailbox number length in System Programming.

Password of the System Manager's Mailbox

The VPS requests to enter the password if it has been assigned. You are responsible for assigning by entering the System Manager's service.

To Access the System Manager's Mailbox

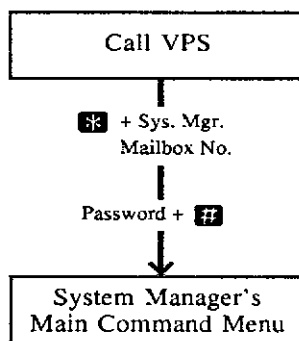

- 1 Dial an **extension number** which is connected to the Voice Mail service. If your VPS does not have one, call any number and press [#] [6] (Service Access Command). You will hear:

*Please enter your party's mailbox number.
To enter by name, press [#] and [1].
If you are using a rotary telephone, stay on the line.
To call the operator, press [0].*

- 2 Press *****, then enter the **System Manager's mailbox number** (99, 999, 9999, or 99999).

Enter your password, followed by [#].

- 3 Enter the **password** followed by **#**. You are now in the **main command menu**.

*To receive the message, press [1].
To deliver a message, press [2].
To customize your mailbox, press [3].
To check the mailbox distribution, press [4].
For a system report, press [5].
For other features, press [6].
To end this call, press [*].*

5.3 Setting up Mailboxes

Your primary duty as System Manager will be to create mailboxes for new VPS Subscribers and to keep the system organized by deleting unneeded passwords and mailboxes. You will also have the task of the System Administrator. All you need to carry out such a job is the mailbox number.

5.3.1 Creating and Editing a Mailbox

One of your jobs as System Manager is to create new mailboxes for new Subscribers and edit mailboxes for established Subscribers instead of the System Administrator. This allows established Subscribers to expand their systems and forms the basis for new Subscribers' systems. To create a new mailbox, you will have to answer a number of prompts. These activate or deactivate certain functions related with the Subscriber's mailbox. Make sure to record each of these decisions for each mailbox on the Worksheets provided.

See **Setting up Mailboxes** in Chapter 4 for detailed information.

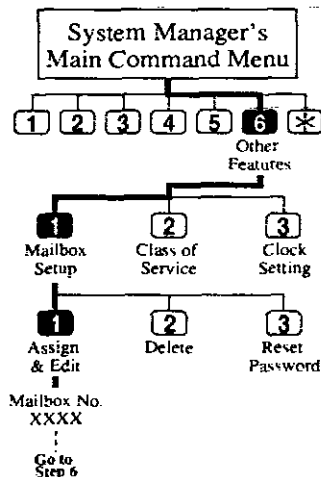

- 1 Log in the main command menu.
- 2 Press **6** for Other Features.
- 3 Press **1** to set up a mailbox.
- 4 Press **1** to assign and edit the mailbox.
- 5 Enter the mailbox number.
- 6 Press **2** to accept.

Subscriber's Voiced Name

To install a mailbox in the system, you must record the Subscriber's name. The VPS allows you to record the name for a maximum of four seconds, and the name should be spoken slowly and clearly. It should be the name by which the Subscriber is most commonly called, because this will be the name he and the system will use for notification of messages or announcements.

- 7 The current owner's name is played.
Press **1** to record a new name.
- 8 Record the name and press **1**.
- 9 Confirm the owner's name and press **2** to accept it.

5.3 Setting up Mailboxes

Extension Number

- 10 The current extension number is played.
Press **1** to enter a new extension.
- 11 Enter the extension number.
- 12 Confirm the extension number and press **2** to accept it.

Initial 3 or 4 Letters of Subscriber's Last Name

- 13 The current owner's name is played.
Press **1** to enter a new owner's name by spelling.
- 14 Enter the first 3 or 4 letters of the owner's last name.
- 15 Confirm the owner's name and press **2** to accept it.

Class of Service No.

- 16 The current Class of Service number is played.
Press **1** to change the COS number.
- 17 Enter the COS number (1 – 64).
- 18 Confirm the COS number and press **2** to accept it.

Interview Mailbox No.

- 19 The current interview mailbox number is played.
Press **1** to set a new interview mailbox number.
These numbers should be different from the owner's mailbox number.
- 20 Enter the new interview mailbox number.
- 21 Confirm the interview mailbox number and press **2** to accept it.

All Calls Transfer to Mailbox

- 22 The current status of all calls transferring is played.
Press **1** to change the current setting (enable or disable).

The mailbox assignment operation is finished and you will go to the prompt of step 3.

You can continue assigning or editing other mailboxes by repeating steps 4 – 22.

To return to the main command menu, press ***** twice.

Tip:

Step 7, 10, 13, 19

- When editing an already assigned mailbox.
 - If you want to delete the current settings, you can press [3].
 - If you do not want to change the settings, you can press [2].

5.3 Setting up Mailboxes

5.3.2. Deleting a Mailbox

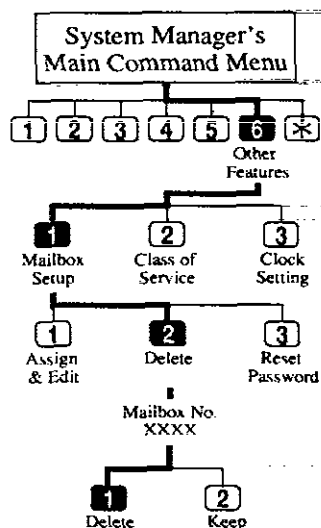

Occasionally, a Subscriber may ask you to delete his mailbox because it is no longer needed. This is one of your tasks as System Manager. All you need to carry out the request is the mailbox number.

See **Deleting a Mailbox** in Chapter 4.

If the mailbox that you wish to delete is being used, the action is canceled with the prompt "Sorry, cannot delete the mailbox now".

- 1 Log in the main command menu.
- 2 Press **6** for Other Features.
- 3 Press **1** to set up a mailbox menu.
- 4 Press **2** to delete the mailbox.
- 5 Enter the mailbox number.
- 6 Press **1** to delete the mailbox.

Tip:

Step 6 -

You can keep the mailbox by pressing [2].

5.3.3 Deleting a Mailbox Password

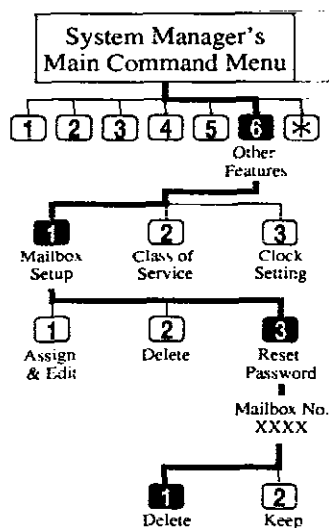

If a Subscriber does happen to forget it, you can erase the current password. This will allow the Subscriber to set a new one. See **Resetting a Mailbox Password** in Chapter 4.

- 1 Log in the main command menu.
- 2 Press **6** for Other Features.
- 3 Press **1** for the Setup Mailbox Menu.
- 4 Press **3** to reset the password.
- 5 Enter the mailbox number.
- 6 Press **1** to delete the password.

Tip:

Step 6 -

You can keep the password by pressing [2].

5.4 Setting COS (Class of Service) Parameters

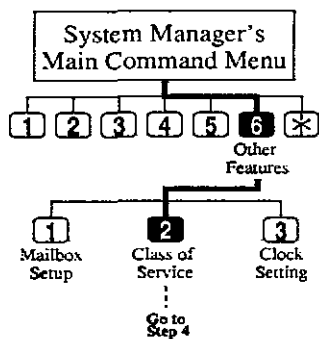

Each Class of Service defines a set of services available for Subscribers. A maximum of 64 Class of Service can be established. You can set each Class of Service from a telephone. For the details of individual description, see **Setting Class of Service Parameters** in Chapter 4. COS No. 63 and No. 64 have been assigned to the Message Manager and the System Manager respectively.

- 1 Log in the main command menu.
- 2 Press **6** for Other Features.
- 3 Press **2** to set the Class of Service.
- 4 Enter the COS number (1 – 64).

Note:

Message Notification Status *2
External Message Delivery Status *1,*2
Auto Forwarding Status *1,*2

*1: Do not set in the COS No. 63 (Message Manager)

*2: Do not set in the COS No. 64 (System Manager)

Personal Greeting Length

- 5 The current setting is played.
Press **1** to change the setting.
- 6 Enter the personal greeting length (8 – 60 seconds).
- 7 Confirm your entry and press **2** to accept it.

New Message Retention Time

- 8 The current setting is played.
Press **1** to change the setting.
- 9 Enter the retention time (up to 30 days).
- 10 Confirm your entry and press **2** to accept it.

Saved Message Retention Time

- 11 The current setting is played.
Press **1** to change the setting (up to 30 days/0: Unlimited).
- 12 Enter the retention time.
- 13 Confirm your entry and press **2** to accept it.

5.4 Setting COS (Class of Service) Parameters

Message Length

- 14 The current setting is played.
Press **1** to change the setting.
- 15 Enter the message length (1 – 6 minutes).
- 16 Confirm your entry and press **2** to accept it.

Number of Messages

- 17 The current setting is played.
Press **1** to change the setting.
- 18 Enter the number of messages (5 – 100).
- 19 Confirm your entry and press **2** to accept it.

Total Message Time

- 20 The current setting is played.
Press **1** to change the setting.
- 21 Enter total message time (5 – 100 minutes).
- 22 Confirm your entry and press **2** to accept it.

Message Retrieval Order

- 23 The current setting is played.
Press **1** to change the current setting (LIFO or FIFO).
- 24 Confirm your entry and press **2** to accept it.

Message Scanning with Information

- 25 The current setting is played.
Press **1** to change the current setting (enable or disable).
- 26 Confirm your entry and press **2** to accept it.

Play System Prompt After Personal Greeting Status

After a mailbox is entered, the system can be set to play the system prompts after the personal greeting.

- 27 The current setting is played.
Press **1** to change the current setting (enable or disable).
- 28 Confirm your entry and press **2** to accept it.

Call Waiting on Busy Status

- 29 The current setting is played.
Press **1** to change the current setting (enable or disable).
- 30 Confirm your entry and press **2** to accept it.

5.4 Setting COS (Class of Service) Parameters

Message Cancel for Live Call Screening Status

- 31 The current setting is played.
Press **1** to change the current setting (enable or disable).
- 32 Confirm your entry and press **2** to accept it.

Direct Mailbox Access Status

- 33 The current setting is played.
Press **1** to change the current setting (enable or disable).
- 34 Confirm your entry and press **2** to accept it.

Intercom Paging Group Number

- 35 The current setting is played.
Press **1** to change the current number.
- 36 Enter the group number (1 – 8).
- 37 Confirm your entry and press **2** to accept it.

Subscriber Service Prompt Mode

- 38 The current setting is played.
Press **1** – **3** to change the desired mode.
- 39 Confirm your entry and press **4** to accept it.

Tip:

Step 38 –

- 1** System Prompt
- 2** User 1 Prompt
- 3** User 2 Prompt
- 4** Accept the current prompt mode

Message Notification Status

- 40 The current setting is played.
Press **1** to change the setting (enable or disable).
If the Message Notification Status is enabled, go to step 41 – 45.
- 41 Press **1** – **5** to choose the desired Beeper Callback No. Entry Mode or press **6** to accept it.

Tip:

Step 41 –

You can set the way of pager access.

- 1** Caller Select Mode
- 2** Without Message Mode
- 3** Before Message Recording Mode
- 4** After Message Recording Mode
- 5** Disable All Entry Mode (Caller cannot access pager)

5.4 Setting COS (Class of Service) Parameters

6 Accept

- 42** The current setting of MWL Notification for Unreceived Message is played.
Press **1** to change the setting (enable or disable).
- 43** Confirm your entry and press **2** to accept.
- 44** The current setting of Device Notification for Unreceived Message is played.
Press **1** to change the setting (enable or disable).
- 45** Confirm your entry and press **2** to accept.

External Message Delivery Status

- 46** The current setting is played.
Press **1** to change the setting (enable or disable).
If the External Message Delivery Status is enabled, you can set the prompt mode for receiving external delivery messages.
- 47** Press **1** - **4** to choose the desired mode or press **5** to accept it.

Tip:

Step 47 -

- 1** System Prompt
- 2** User 1 Prompt
- 3** User 2 Prompt
- 4** Selective Prompt
- 5** Accept

Auto Forwarding Status

- 48** The current setting is played.
Press **1** to change or **2** to accept.
If Auto Forwarding is enabled, go to step 49 - 55.
- 49** Press **1** to change the mailbox number.
- 50** Enter the mailbox number.
- 51** Confirm your entry and press **2** to accept it.
- 52** Press **1** to change delay time.
The delay time is the amount of time after which the message will be automatically forwarded. For example, 1 hour and 15 minutes is 115#, 30 minutes is 30#.
- 53** Confirm your entry and press **2** to accept it.
- 54** Press **1** to change the current forwarding mode (copy or move).
- 55** Confirm your entry and press **2** to accept it.

5.5 Setting the System Clock

You can set the clock of the VPS from your own telephone. It is important to set the exact time as Message Waiting Notification, External Message Delivery, redialing and re-scheduling of External Message Delivery or automatic message deletion are scheduled according to this setting. The System Administrator or the Message Manager can also set the clock.

The system automatically adjusts the time as appropriate when daylight saving time begins and when it ends. See **Daylight Saving Time** in Chapter 4.

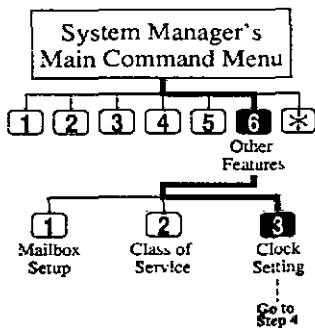

- 1 Log in the main command menu.
- 2 Press **6** for Other Features.
- 3 Press **3** to set the time and date.
- 4 Press **1** to change the current time.
- 5 Enter the current time and press **#**.
- 6 Press **1** for 'AM' or **2** for 'PM'.
- 7 Press **2** to accept the time.
- 8 Press **1** to change the current date.
- 9 Enter the current month and press **#**.
- 10 Enter the day and press **#**.
- 11 Enter the last two digits of the year and press **#**.
- 12 Press **2** to accept the date.

Tip:

Step 3 –

You cannot access the clock setting menu if the System Administrator or the Message Manager is editing the time.

Step 5 –

If you press [0] for help here:

"For example, to enter 5 o'clock, press [5] and [#] or to enter 5:15, press [5], [1], [5] and [#]".

Step 9 –

If you press [0] for help with this setting:

"For example, to enter January, press [1] and [#]".

5.6 Checking System Usage (System Reports)

You can output eight types of System Reports to help monitor the VPS operating status. The reports can be sent via the RS-232C port either to a printer or a terminal. The following eight report options are available.

The System Administrator is also able to output system reports. Details of each report are described **System Reports** in Chapter 7.

5.6.1 Obtaining System Reports

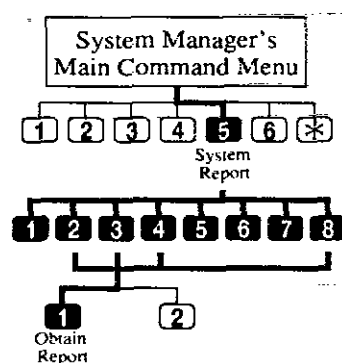

Tip:

- 1 Log in the main command menu.
- 2 Press **5** for the System Report Menu.
- 3 Press **1** - **8** to obtain the desired report.
- 4 Press **1** to obtain the report.

To obtain the Mailbox Usage Report, go to the next step.

- 5 Enter the mailbox number.
To get the information about mailboxes from No. 200 to No. 209, enter "20#". If a [#] is entered for each digit of mailbox numbers (e.g., [#] [#] [#] for 3-digit mailbox numbers), then all reports will be printed and you will return to the System Report Menu.
- 6 Press **1** to specify the mailbox range, and enter the mailbox number or press **2** to obtain all mailbox usage counts. This mailbox number is the upper limit of the mailbox range. The mailbox number entered in step 5 is the lower limit of the range.

Step 3 -

- 1** System Service Report
- 2** Disk Usage Report
- 3** Port Usage Report
- 4** Mailbox Usage Report
- 5** Mailbox Parameter Report
- 6** Call Account Report
- 7** Class of Service Parameter Report
- 8** Fax Call Report

Mailbox Parameter Report is displayed as "Mailbox Assignments". Also, Class of Service Parameter Report is displayed as "COS Assignments" in Chapter 7.

5.6 Checking System Usage (System Reports)

5.6.2 Clearing the Reports

You can clear the counts of the following reports.

- Port Usage Report
- Disk Usage Report
- Mailbox Usage Report
- Fax Call Report

1-3 Same as Obtaining System Reports.

Here, press **2** to clear the Disk Usage Reports, **3** to clear the Port Usage Reports, **4** to clear the Mailbox Usage Reports, or **8** to clear the Fax Call Report.

4 Press **2** to clear the reports.

To clear the Mailbox Usage Reports, go to the next step.

5 Enter the mailbox number.

If [#] is entered, all Mailbox Usage Reports are cleared.

6 Press **1** to specify the mailbox range, and enter the mailbox number.

Press **2** to clear all Mailbox Usage Reports.

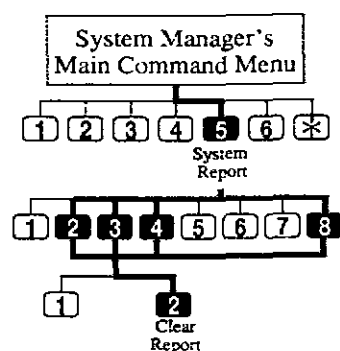

5.7 Delivering Messages

Two ways of message delivery are available. You can also check whether each message has been delivered successfully.

5.7.1 Delivering Messages to All Mailboxes (Broadcasting Messages)

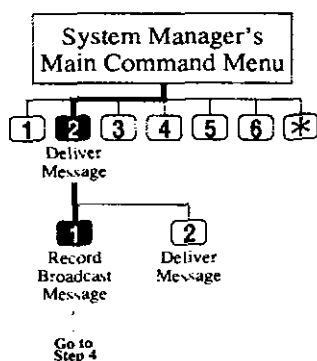

You can deliver an identical message to all VPS Subscribers at the same time. This procedure is referred to as Broadcasting Messages, and the message to be broadcast is recorded in the System Manager's mailbox. This feature is useful for informing all Subscribers about current VPS status such as remaining hard disk capacity, requesting that unnecessary messages be erased, etc.

- 1 Log in the main command menu.
- 2 Press **2** to deliver a message.
- 3 Press **1** to record a broadcast message.
- 4 Record a broadcast message and press **1**.
- 5 Press **2** to accept.

5.7.2 Delivering Messages to Specified Mailboxes

You can also deliver messages to more than one Subscriber's mailboxes by specifying them. You can designate messages as private, urgent and their delivery date and time.

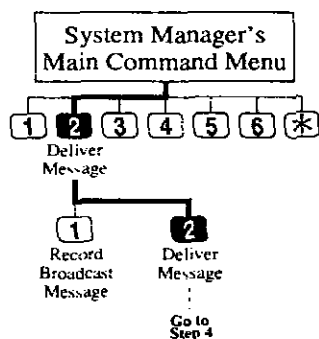

- 1 Log in the main command menu.
- 2 Press **2** to deliver a message.
- 3 Press **2** to deliver a message.
- 4 Enter the mailbox number of the intended recipient.
- 5 Press **2** to accept the number if it is correct.
- 6 Press **1** to record a message.
- 7 State your message at the tone and press **1**.
- 8 Press **2** to accept.
- 9 Press **1** to specify the delivery time and the private status.
- 10 Press **1** to specify the delivery time.
- 11 Enter the time and **#**.
- 12 Press **1** for 'AM' or **2** for 'PM'.

5.7 Delivering Messages

- 13 Enter **the date** (the day of the month) and **#**.
- 14 Press **2** to accept.
- 15 Press **1** to set this message to a private message. Otherwise, press **2**.

Tip:

Step 4 –

You can enter by name if you press [#] [1] first.
You can use a System Group Distribution List by specifying its number.

Step 5 –

You can add mailbox numbers by pressing [2], review the mailing list by pressing [3] and cancel message transfer by pressing [*].

Step 9 –

You can end message delivery and return to the main command menu by pressing [2].

5.7.3 Checking Mailbox Distribution

You can check whether or not messages have been delivered to recipients.

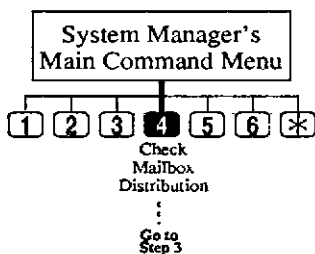

- 1 Log in **the main command menu**.
- 2 Press **4** to check distribution status.
- 3 Press **3** to cancel the message or delete verification.
- 4 Press **1** to delete verification of this message, or **2** to cancel message delivery.

Tip:

Step 3 –

You can listen to the message by pressing [1].
You can check the previous message by pressing [1] twice.
You can check the next message by pressing [2].

5.8 Customizing the System Manager's Mailbox

In order to ensure system security, you can establish a password consisting of up to eight numeric characters. Anyone requesting access to the System Manager's service will then be required to enter this password before proceeding.

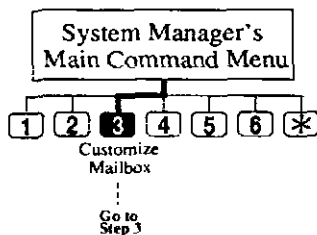

- 1 Log in the main command menu.
- 2 Press **3** to customize your mailbox. Then you will hear the current setting.
- 3 Press **1** to change the mailbox password.
- 4 Enter the password and **#**.
- 5 Press **2** to accept.

Tip:

Step 4 -

If you do not need the password, you can press [#]. However, it is recommended to set the password to protect your mailbox.

5.9 Listening to Messages

Subscribers may call you for asking you to create new mailboxes, to delete unneeded ones, to delete the password as they have forgotten theirs, to change the COS number, to authorize a special feature, and everything. You can receive these messages left in the System Manager's mailbox in the following manner.

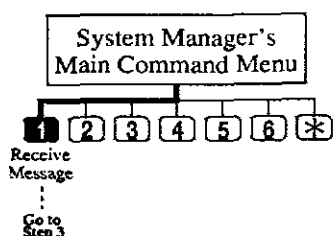

- 1 Log in the main command menu.
- 2 The VPS plays the number of new messages. Press **1** to listen to the messages.
- 3 The VPS plays the message along with the information on who is the sender and when it was recorded. Press **0** to show the whole menu (for Help).

Tip:

Step 3 –

You do not have to listen to the whole menu if you do not wish to.

You can end your call by pressing [#] [9].

- 1** Repeat this message
- 1 1** Play the previous message
- 2** Play the next message
- 3** Erase this message
- 4** Reply
- 5** Rewind
- 6** Fast forward
- 7** Transfer
- 8** Message scan



Chapter 6

Message Manager's Guide

This chapter explains the Message Manager's function and provides step-by-step instructions for message management tasks such as routing messages in the General Delivery Mailbox.

Contents

6.1 Message Manager's Function	6-2
6.2 Accessing the Message Manager's Mailbox	6-3
6.3 Managing the General Delivery Mailbox	6-5
6.3.1 Listening to Messages	6-5
6.3.2 Transferring Messages	6-6
6.4 Setting up Message Waiting Notification	6-7
6.4.1 Setting Message Waiting Lamp Status	6-7
6.4.2 Setting Notification by Calling Status	6-7
6.4.2.1 Setting Device Status	6-7
6.4.2.2 Assigning Notification Numbers	6-8
6.5 Customizing the Message Manager's Mailbox	6-10
6.5.1 Message Manager's Password	6-10
6.5.2 Operator's Extensions	6-10
6.6 Setting the System Clock	6-11
6.7 Recording Company Messages	6-12
6.7.1 Recording Company Greetings	6-12
6.7.2 Recording Company Name	6-12
6.7.3 Recording Department Dialing Menu Messages	6-13
6.7.4 Recording Custom Service Menu Messages ...	6-14
6.7.5 Recording Voice Labels for Mailbox Lists	6-15
6.7.6 Recording User Prompts	6-15
6.7.7 Recording Selection Menus	6-16
List of Modifiable Prompts	6-18

6.1 Message Manager's Function

As Message Manager, you take care of the General Delivery Mailbox, recording company greetings, and voice prompts by accessing your mailbox with number 98, 998 (default value), 9998 or 99998 (these values can be changed). You will also be responsible for answering and attending to calls that have been transferred by the VPS.

You will also transfer messages recorded in the General Delivery Mailbox to their destination mailboxes. When someone is calling from a rotary telephone, the VPS may guide him to the General Delivery Mailbox and allow him to leave his message there. You will then transfer the message from the General Delivery Mailbox to the mailbox of the intended party, depending upon the contents of the message.

The VPS can have up to 32 company greetings for both business and non-business hour greetings. Depending on the company's working hours, you will record these greetings and select which one is to be delivered to each port of the VPS.

As Message Manager, you can also modify prerecorded prompts from the Automated Attendant and Voice Mail service. You can record your own prompts from your telephone at any time simply by specifying the prompt number and stating the new one into your telephone.

Before starting message management

Use the **Worksheets** provided to record the information you will need to do your tasks throughout the system. Just fill in the blanks with the information requested. Once you have finished filling out the Worksheets, you can use them as quick reference cards to aid you in message management.

6.2 Accessing the Message Manager's Mailbox

You can gain access to Message Manager's service by entering your mailbox. To enter that mailbox, you will need the following information beforehand.

- **Telephone Number Directly Connected to the Voice Mail Service**
If your VPS does not have one, call any number and press [#] [6] (Service Access Command).
- **Message Manager's Mailbox Number**
It has been assigned as '98', '998', '9998', or '99998'. It depends upon the mailbox number length in System Programming.
- **Password of the Message Manager's Mailbox**
The VPS requests you to enter the password if it has been assigned. You are responsible for assigning it by entering the Message Manager's service.

To access the message manager's mailbox

- 1 Dial **an extension number** which is connected to the Voice Mail service.

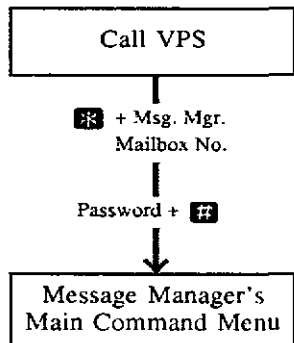

*Please enter your party's mailbox number.
To enter by name, press [#] and [1].
If you are using a rotary telephone, stay on the line.
To call the operator, press [0].*

- 2 Press *, then enter **the Message Manager's mailbox number** (98, 998, 9998, or 99998).

Enter your password, followed by [#].

- 3 Enter **the password** followed by #. You will hear **the main command menu**.

6.2 Accessing the Message Manager's Mailbox

To transfer general delivery mailbox messages, press [1].

To set up message waiting notification, press [2].

To customize your mailbox, press [3].

To set the clock, press [4].

To modify message, press [5].

To end this call, press [].*

6.3 Managing the General Delivery Mailbox

One of your duties as Message Manager will be to check the General Delivery Mailbox for messages and forward them to the appropriate mailbox. This can be done at any time with your telephone. You can listen to the messages in the General Delivery Mailbox and transfer the message to a Subscriber's mailbox or delete the message.

6.3.1 Listening to Messages

By accessing the Message Manager's mailbox, you can monitor the status of the General Delivery Mailbox and listen to messages stored in it. After listening to a message, you can transfer it to the mailbox of the intended recipient and erase it.

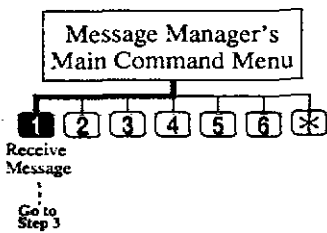

- 1 Log in the main command menu.
- 2 The VPS plays the number of messages. Press **1** to listen to the messages.
- 3 The VPS plays the number of messages, and then play the message with the message information. Press **0** to listen to the whole menu (for Help).

You can end your call by pressing **# 9**.

Tip:

Step 3 –

You do not have to listen to the whole menu if you do not wish to.

- 1** Repeat this message
- 1 1** Play the previous message
- 2** Play the next message
- 3** Erase this message
- 4** Reply
- 5** Rewind
- 6** Fast forward
- 7** Transfer
- 8** Message scan

6.3 Managing the General Delivery Mailbox

6.3.2 Transferring Messages

You can transfer messages left in the General Delivery Mailbox to the mailboxes of intended subscribers, appending additional voice comments if necessary. Once a message has been transferred, the original can be deleted from the General Delivery Mailbox.

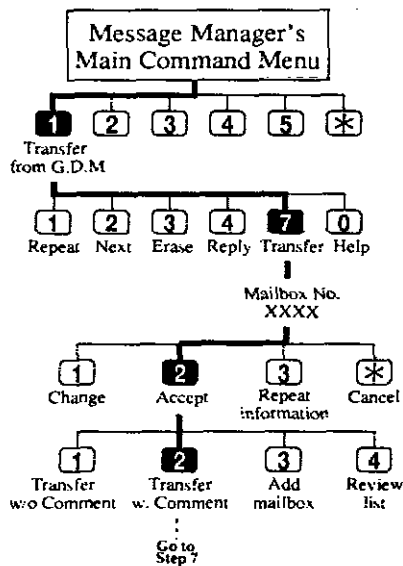

- 1 Log in the main command menu.
- 2 Press **1** to transfer messages from the general delivery mailbox.
- 3 The VPS plays the first (next/last) message. Press **7** to transfer the message.
- 4 Enter the destination mailbox number.
- 5 Press **2** to accept the number.
- 6 Press **2** to transfer with comment.
- 7 Record your comment and press **1**.
- 8 Press **2** to accept.

Tip:

Step 6 -

You can transfer without comment by pressing [1], add mailbox number by pressing [3], review mailing list by pressing [4], or cancel message transfer by pressing [5].

6.4 Setting up Message Waiting Notification

You can have the VPS notify that unplayed messages are waiting in your mailbox. You do not need to regularly check your mailbox.

This feature has been authorized at the factory.

Two types of message waiting notification are available: notification by message waiting lamp and notification by calling. They can be enabled or disabled respectively.

6.4.1 Setting Message Waiting Lamp Status

The VPS illuminates the message waiting lamp on your telephone when a new message is recorded in your mailbox.

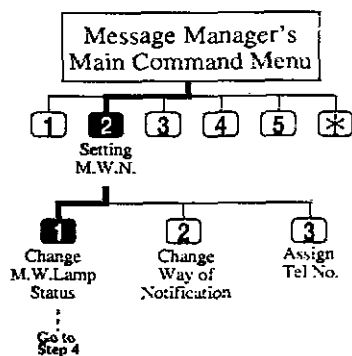

- 1 Log in the main command menu.
- 2 Press **2** to set Message Waiting Notification.
- 3 Press **1** to change the Message Waiting Lamp Notification Status.
- 4 Press **1** to change the Message Waiting Lamp Notification status, or **2** to accept it.

6.4.2 Setting Notification by Calling Status

The VPS calls the preset telephone or beeper when a new message is recorded in your mailbox. Set the following three parameters as appropriate.

6.4.2.1 Setting Device Status

For each device, the notification is enabled, disabled or enabled on the preset schedule.

If you want to enable it on the schedule, contact with your System Administrator as you are not allowed to set the schedule yourself.

6.4 Setting up Message Waiting Notification

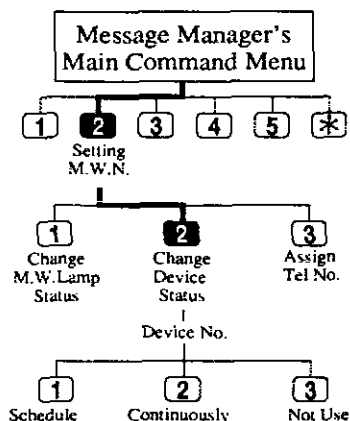

- 1-2 Same as the **Message Waiting Lamp Status**.
- 3 Press **2** to change the way of notification.
- 4 Enter the **device number**.
- 5 Press **1** - **3** to select the status.

Tip:

Step 3 -

- 1** Schedule (enabled on the schedule)
- 2** Continuously (enabled whole day)
- 3** Not Use (disabled whole day)

6.4.2.2 Assigning Notification Numbers

You can set up to three telephone or beeper numbers where you wish to receive notification. You can use the keys '0' to '9', a tone/pulse switches, the beeper callback number display entry code 'X'.

If you add the Beeper Callback No. Entry Code at the end of a beeper number, the notification is made in a little different way. The VPS asks the caller to enter the number to which he wishes to be called and displays it on the LCD of your beeper. The timing of the callback number entry is either before, after or without recording message. It depends on System Programming.

It is also possible to have the caller select whether or not enter the number.

You must have your System Manager authorize the use of the Beeper Callback No. Entry Code.

- 1-2 Same as the **Message Waiting Lamp Status**.
- 3 Press **3** to assign the telephone number.

6.4 Setting up Message Waiting Notification

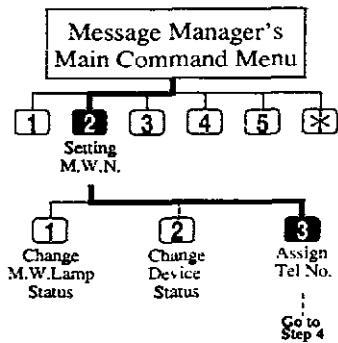

Tip:

- 4 Press **1** to change the first telephone number, **2** to change the second telephone number or **3** to change the third telephone number.
- 5 Press **1** to set the telephone number.
- 6 Enter the telephone number.
- 7 Press **2** to accept.
- 8 Select **1** to be notified by telephone or **2** by a beeper.

Step 7 -

- 1** Change the telephone number
- 2** Accept
- 3** Review
- 4** Add more digits
- 5** Insert a pause
- 6** Set dial mode
- 7** Insert a wait for dial tone
- 8** Insert a beeper display command

6.5 Customizing the Message Manager's Mailbox

As Message Manager, you can customize your mailbox by specifying the password and the extension numbers of the operators 1, 2 and 3.

6.5.1 Message Manager's Password

You can specify your password from your telephone at any time to protect the General Delivery Mailbox and company greetings. The password can have up to 8 numeric characters and must be entered to execute the message management operation.

6.5.2 Operator's Extensions

A caller who would like to have the help of the operator is transferred to the extension specified by you. You can then specify the extension which the caller will connect to when he enters [0], the operator key.

Up to three operators (Operator 1, 2, 3) can be specified for both Day and Night modes respectively.

It is usual to set your extension as the Operator 1.

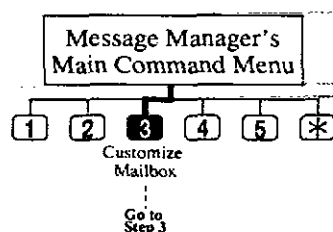

- 1 Log in the main command menu.
- 2 Press **3** to customize your mailbox.
- 3 The VPS plays the current password setting. Press **1** to change the password.
- 4 Enter the password and **##**.
- 5 The VPS repeats what you entered. Press **2** to accept.
- 6 The VPS plays the current operator's extension setting. Press **1** to change the operator's extension. If the operator's extension is unassigned, you will go to step 7.
- 7 Enter the extension.
- 8 The VPS will repeat the extension you just entered. Press **2** to accept.
- 9 Repeat the steps 6 to 8 to assign the extension for the day mode and night mode of each operator.

Tip:

Step 3, 6 –

You can accept the current settings by pressing [2].

6.6 Setting the System Clock

The System Administrator or the System Manager sets the present date and time of the VPS from his own telephone, but also you, the Message Manager, can set them if the system clock is not being accessed by the System Manager or the System Administrator. It is important to set the exact time since Message Waiting Notification, External Message Delivery, redialing and rescheduling of External Message Delivery or automatic message deletion are scheduled according to this setting.

The system automatically adjusts the time as appropriate when daylight saving time begins and when it ends. See **Daylight Saving Time** in Chapter 4.

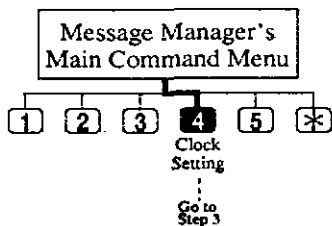

- 1 Log in the main command menu.
- 2 Press **4** to set the time and date.
- 3 Press **1** to change the current setting.
- 4 Enter the current time and **#**.
- 5 Enter **1** for 'AM' or **2** for 'PM'.
- 6 Press **2** to accept.
- 7 Press **1** to change current setting.
- 8 Enter the month and press **#**.
- 9 Enter the day and press **#**.
- 10 Enter the last two digits of the year and press **#**.
- 11 Press **2** to accept.

Tip:

Step 2 –

You cannot access the clock setting menu if the System Administrator or the System Manager is editing the time.

Step 4 –

If you press [0] for help here:

"For example, to enter 5 o'clock, press [5] and [#] or to enter 5:15, press [5], [1], [5] and [#]".

Step 8 –

If you press [0] for help with this setting:

"For example, to enter January, press [1] and [#]".

6.7 Recording Company Messages

You are responsible for recording messages or greetings which are to be recorded by each user respectively.

6.7.1 Recording Company Greetings

You can record up to 32 company greetings and erase them as appropriate. The greeting will be business or non-business hour greetings of which one will be presented to the caller of the VPS.

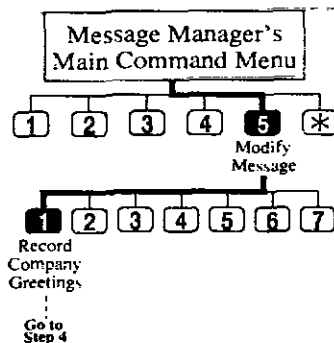

- 1 Log in the main command menu.
- 2 Press **5** to modify messages.
- 3 Press **1** to record company greetings.
- 4 Enter the company greeting number (1 – 32).
- 5 The VPS plays the current greeting. Press **1** to change the greeting. If you have not recorded the company greeting, go to step 7.
- 6 Press **1** to record the greeting. If you press [2], the current company greeting is erased.
- 7 Record the company greeting and press **1**.
- 8 Press **2** to accept.
- 9 You can record other company greetings by repeating steps 3 to 8.

Tip:

Step 4 –

If you have not recorded the greeting for this number, you can directly record a greeting.

Step 7 –

You have up to 6 minutes for recording.

Step 8 –

You can review the recording by pressing [1], record a new one by pressing [3], add recording by pressing [4], or erase and exit by pressing [*].

6.7.2 Recording Company Name

You will record the company name that the external delivery message receiver will hear when he forgets the external message delivery password. The VPS provides a callback message including the company name.

6.7 Recording Company Messages

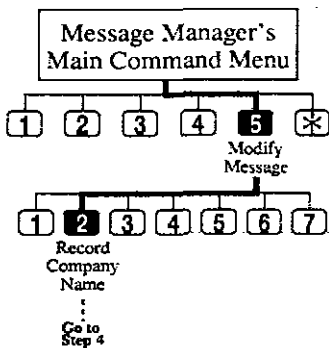

Tip:

- 1 Log in the main command menu.
- 2 Press **5** to modify messages.
- 3 Press **2** to record company name.
- 4 The VPS plays the current company name.
Press **1** to change the name.
If you have not recorded a company name, go to step 6.
- 5 Press **1** to record the name.
- 6 Record the company name and press **1**.
- 7 Press **2** to accept.

Step 5 -

You can erase the company name by pressing [2].

Step 6 -

You have up to 6 minutes for recording.

Step 8 -

You can review the recording by pressing [1], record a new one by pressing [3], add recording by pressing [4], or erase and exit by pressing [*].

6.7.3 Recording Department Dialing Menu Messages

Rather than dial long, complicated numbers, it is possible to reach an extension by entering one number. Due to the fact that there are only nine digits (1-9) to choose from, the caller is limited to nine department dialing numbers. The VPS allows you to record or erase the department dialing menu message that provides the voiced names of departments to which the caller will be transferred by department dialing.

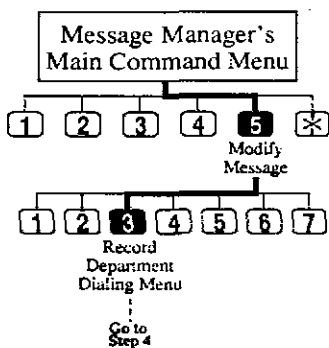

- 1 Log in the main command menu.
- 2 Press **5** to modify messages.
- 3 Press **3** to change the Department Dialing Programming menu.
- 4 The VPS plays the current Department Dialing Menu.
Press **1** to record the Department Dialing Menu.
If you have not recorded a menu, go to step 6.
- 5 Press **1** to record.
- 6 Record the menu and press **1**.
- 7 Press **2** to accept.

6.7 Recording Company Messages

Tip:

Step 5 –

You can erase the department dialing menu by pressing [2].

Step 6 –

You have up to 6 minutes for recording.

Step 7 –

You can review the recording by pressing [1], record a new one by pressing [3], add recording by pressing [4], or erase and exit by pressing [*].

6.7.4 Recording Custom Service Menu Messages

The VPS accommodates up to 100 custom services.

You will either record the menu or delete it if appropriate.

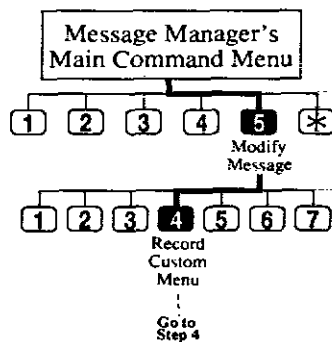

1 Log in the main command menu.

2 Press **5** to modify messages.

3 Press **4** to record a custom menu.

4 Enter the custom number (1 – 100).

5 The VPS plays the current menu. Press **1** to change the menu.

If you have not recorded a menu for this number, go to step 7.

6 Press **1** to record menu.

7 Record the menu and press **1**.

8 Press **2** to accept.

9 You can record other menus by repeating steps 4 to 8.

Tip:

Step 4 –

You can record the final guidance message for Exit by pressing [0].

Step 6 –

You can erase the menu by pressing [2].

Step 7 –

You have up to 6 minutes for recording.

Step 8 –

You can review the recording by pressing [1], record a new one by pressing [3], add recording by pressing [4], or erase and exit by pressing [*].

6.7 Recording Company Messages

6.7.5 Recording Voice Labels for Mailbox Lists

Up to 20 mailbox distribution group lists can be created by the System Administrator. You can either record or erase the name of each list.

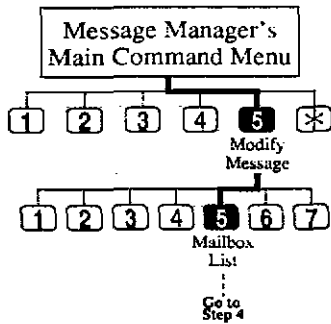

- 1 Log in the main command menu.
- 2 Press **[5]** to modify messages.
- 3 Press **[5]** to record labels for the mailbox lists.
- 4 Enter the mailbox list number to be labeled.
- 5 The VPS plays the current label. Press **[1]** to change the label.
If you have not recorded a voice label for this mailbox list, go to step 7.
- 6 Press **[1]** to record the label.
- 7 Record the label and press **[1]**.
- 8 Press **[2]** to accept.
- 9 You can record other mailbox list labels by repeating steps 4 to 8.

Tip:

- Step 6 –**
You can erase the label by pressing [2].
- Step 7 –**
You have up to 6 minutes for recording.
- Step 8 –**
You can review the recording by pressing [1], record a new one by pressing [3], add recording by pressing [4], or erase and exit by pressing [*].

6.7.6 Recording User Prompts

To support the Multi-Lingual service in your VPS, you have to record the "User 1 Prompt" or the "User 2 Prompt". Once the recorded prompts have been saved in the personal computer with the command "SAVE" via RS-232C, it is possible to restore them with the command "LOAD" in the VPS at any time (see **Utility Commands** in Chapter 7).

Note: The list of modifiable prompts and prompt numbers appear at the end of this chapter.

- 1 Log in the main command menu.
- 2 Press **[5]** to modify messages.

6.7 Recording Company Messages

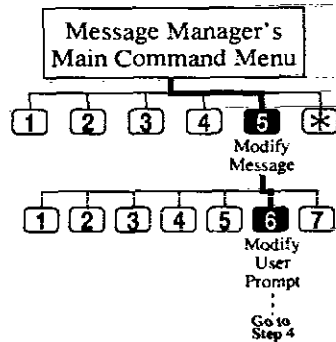

- 3 Press **6** to modify user prompts.
- 4 Press **1** to change user prompt 1, or **2** to change user prompt 2.
- 5 Press **1** to change the prompt that you are specifying.
- 6 Enter the **prompt number**.
- 7 Press **1** to change the prompt.
If you press [2], you will be back to step 6.
- 8 The VPS plays the current recording. Press **1** to change the prompt.
If you press [2], the current recording is kept.
- 9 Press **1** to record a new prompt.
If you press [2], the current prompt is erased.
- 10 State a **prompt** and press **1**.
- 11 Press **2** to accept.
- 12 You can record other user prompts by repeating steps 6 to 11.

Tip:

Step 5 –

By pressing [2], you can record the prompt in a row without reviewing the current recording. You will go to step 9.

Step 6 –

For the numbers of the modifiable prompts, see at the end of this chapter.

Step 7, 9 –

By pressing [3], you can turn off the specified prompt.

Step 10 –

You have up to 6 minutes for recording.

Step 12 –

You can review the recording by pressing [1], record a new one by pressing [3], add recording by pressing [4], or erase and exit by pressing [*].

6.7.7 Recording Selection Menus

Before using the Multi-Lingual service, it is necessary for you to record the selection menu of the languages that the VPS supports.

Listening to this selection menu, the caller can choose one he wishes to use in the subsequent operation.

[Example]

You will record:

"To use our voice message service in English, press [8]. in Spanish, press [9]".

6.7 Recording Company Messages

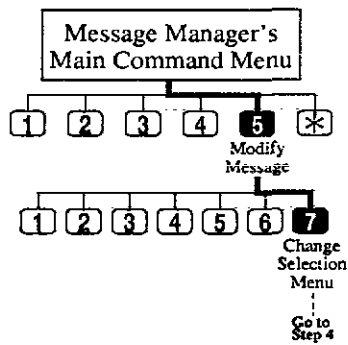

Tip:

- 1 Log in the main command menu.
- 2 Press **5** to modify messages.
- 3 Press **7** to change the selection menu.
- 4 The VPS plays the current selection menu.
Press **1** to change the menu.
If you have not recorded the selection menu, go to step 6.
- 5 Press **1** to record the menu.
If you press [2], the current menu is erased.
- 6 Record the menu and press **1**.
- 7 Press **2** to accept.

Step 6 –

You have up to 6 minutes for recording.

Step 7 –

You can review the recording by pressing [1], record a new one by pressing [3], add recording by pressing [4], or erase and exit by pressing [*].

List of Modifiable Prompts

The table below shows the modifiable prompts. Record them as the User 1 or the User 2 prompt. Some of the modifiable prompts are listed along with the linked prompt number. In order to make certain sentences in one voice, record the related prompts together (see **Voice Prompts** in Chapter 3).

Prompt No.	Modifiable Prompt
1	ZERO
2	ONE
3	TWO
4	THREE
5	FOUR
6	FIVE
7	SIX
8	SEVEN
9	EIGHT
10	NINE
11	TEN
12	ELEVEN
13	TWELVE
14	THIRTEEN
15	FOURTEEN
16	FIFTEEN
17	SIXTEEN
18	SEVENTEEN
19	EIGHTEEN
20	NINETEEN
21	TWENTY
22	TWENTY ONE
23	TWENTY TWO
24	TWENTY THREE
25	TWENTY FOUR
26	TWENTY FIVE
27	TWENTY SIX
28	TWENTY SEVEN
29	TWENTY EIGHT
30	TWENTY NINE
31	THIRTY
32	THIRTY ONE
33	THIRTY TWO

Prompt No.	Modifiable Prompt
34	THIRTY THREE
35	THIRTY FOUR
36	THIRTY FIVE
37	THIRTY SIX
38	THIRTY SEVEN
39	THIRTY EIGHT
40	THIRTY NINE
41	FORTY
42	FORTY ONE
43	FORTY TWO
44	FORTY THREE
45	FORTY FOUR
46	FORTY FIVE
47	FORTY SIX
48	FORTY SEVEN
49	FORTY EIGHT
50	FORTY NINE
51	FIFTY
52	FIFTY ONE
53	FIFTY TWO
54	FIFTY THREE
55	FIFTY FOUR
56	FIFTY FIVE
57	FIFTY SIX
58	FIFTY SEVEN
59	FIFTY EIGHT
60	FIFTY NINE
61	SIXTY
62	SIXTY ONE
63	SIXTY TWO
64	SIXTY THREE
65	SIXTY FOUR
66	SIXTY FIVE

List of Modifiable Prompts

Prompt No.	Modifiable Prompt
67	SIXTY SIX
68	SIXTY SEVEN
69	SIXTY EIGHT
70	SIXTY NINE
71	SEVENTY
72	SEVENTY ONE
73	SEVENTY TWO
74	SEVENTY THREE
75	SEVENTY FOUR
76	SEVENTY FIVE
77	SEVENTY SIX
78	SEVENTY SEVEN
79	SEVENTY EIGHT
80	SEVENTY NINE
81	EIGHTY
82	EIGHTY ONE
83	EIGHTY TWO
84	EIGHTY THREE
85	EIGHTY FOUR
86	EIGHTY FIVE
87	EIGHTY SIX
88	EIGHTY SEVEN
89	EIGHTY EIGHT
90	EIGHTY NINE
91	NINETY
92	NINETY ONE
93	NINETY TWO
94	NINETY THREE
95	NINETY FOUR
96	NINETY FIVE
97	NINETY SIX
98	NINETY SEVEN
99	NINETY EIGHT
100	NINETY NINE
101	HUNDRED
102	MORE THAN HUNDRED

Prompt No.	Modifiable Prompt
103	AM
104	PM
105	O'CLOCK
106	ONE (AM HOUR)
107	TWO (AM HOUR)
108	THREE (AM HOUR)
109	FOUR (AM HOUR)
110	FIVE (AM HOUR)
111	SIX (AM HOUR)
112	SEVEN (AM HOUR)
113	EIGHT (AM HOUR)
114	NINE (AM HOUR)
115	TEN (AM HOUR)
116	ELEVEN (AM HOUR)
117	TWELVE (PM HOUR)
118	ONE (PM HOUR)
119	TWO (PM HOUR)
120	THREE (PM HOUR)
121	FOUR (PM HOUR)
122	FIVE (PM HOUR)
123	SIX (PM HOUR)
124	SEVEN (PM HOUR)
125	EIGHT (PM HOUR)
126	NINE (PM HOUR)
127	TEN (PM HOUR)
128	ELEVEN (PM HOUR)
129	TWELVE (AM HOUR)
130	ONE (MINUTE)
131	TWO (MINUTE)
132	THREE (MINUTE)
133	FOUR (MINUTE)
134	FIVE (MINUTE)
135	SIX (MINUTE)
136	SEVEN (MINUTE)
137	EIGHT (MINUTE)
138	NINE (MINUTE)

List of Modifiable Prompts

Prompt No.	Modifiable Prompt
139	TEN (MINUTE)
140	ELEVEN (MINUTE)
141	TWELVE (MINUTE)
142	THIRTEEN (MINUTE)
143	FOURTEEN (MINUTE)
144	FIFTEEN (MINUTE)
145	SIXTEEN (MINUTE)
146	SEVENTEEN (MINUTE)
147	EIGHTEEN (MINUTE)
148	NINETEEN (MINUTE)
149	TWENTY (MINUTE)
150	TWENTY ONE (MINUTE)
151	TWENTY TWO (MINUTE)
152	TWENTY THREE (MINUTE)
153	TWENTY FOUR (MINUTE)
154	TWENTY FIVE (MINUTE)
155	TWENTY SIX (MINUTE)
156	TWENTY SEVEN (MINUTE)
157	TWENTY EIGHT (MINUTE)
158	TWENTY NINE (MINUTE)
159	THIRTY (MINUTE)
160	THIRTY ONE (MINUTE)
161	THIRTY TWO (MINUTE)
162	THIRTY THREE (MINUTE)
163	THIRTY FOUR (MINUTE)
164	THIRTY FIVE (MINUTE)
165	THIRTY SIX (MINUTE)
166	THIRTY SEVEN (MINUTE)
167	THIRTY EIGHT (MINUTE)
168	THIRTY NINE (MINUTE)
169	FORTY (MINUTE)
170	FORTY ONE (MINUTE)
171	FORTY TWO (MINUTE)
172	FORTY THREE (MINUTE)
173	FORTY FOUR (MINUTE)
174	FORTY FIVE (MINUTE)

Prompt No.	Modifiable Prompt
175	FORTY SIX (MINUTE)
176	FORTY SEVEN (MINUTE)
177	FORTY EIGHT (MINUTE)
178	FORTY NINE (MINUTE)
179	FIFTY (MINUTE)
180	FIFTY ONE (MINUTE)
181	FIFTY TWO (MINUTE)
182	FIFTY THREE (MINUTE)
183	FIFTY FOUR (MINUTE)
184	FIFTY FIVE (MINUTE)
185	FIFTY SIX (MINUTE)
186	FIFTY SEVEN (MINUTE)
187	FIFTY EIGHT (MINUTE)
188	FIFTY NINE (MINUTE)
189	JANUARY
190	FEBRUARY
191	MARCH
192	APRIL
193	MAY
194	JUNE
195	JULY
196	AUGUST
197	SEPTEMBER
198	OCTOBER
199	NOVEMBER
200	DECEMBER
201	MONDAY
202	TUESDAY
203	WEDNESDAY
204	THURSDAY
205	FRIDAY
206	SATURDAY
207	SUNDAY
208	FIRST
209	SECOND
210	THIRD

List of Modifiable Prompts

Prompt No.	Modifiable Prompt	Linked to Prompt No(s).
211	FOURTH	
212	FIFTH	
213	SIXTH	
214	SEVENTH	
215	EIGHTH	
216	NINTH	
217	TENTH	
218	ELEVENTH	
219	TWELFTH	
220	THIRTEENTH	
221	FOURTEENTH	
222	FIFTEENTH	
223	SIXTEENTH	
224	SEVENTEENTH	
225	EIGHTEENTH	
226	NINETEENTH	
227	TWENTIETH	
228	TWENTY FIRST	
229	TWENTY SECOND	
230	TWENTY THIRD	
231	TWENTY FOURTH	
232	TWENTY FIFTH	
233	TWENTY SIXTH	
234	TWENTY SEVENTH	
235	TWENTY EIGHTH	
236	TWENTY NINTH	
237	THIRTIETH	
238	THIRTY FIRST	
239	STAR (*)	
240	HASH (#)	
241	PAUSE	
242	tone dialing mode	
243	pulse dialing mode	
244	dial tone	
245	callback number	
246	Mailbox	

List of Modifiable Prompts

Prompt No.	Modifiable Prompt	Linked to Prompt No(s).
247	and	[536], [537], [247] [547], [247]
248	at	[314], [248] [415], [416], [248] [417], [248], [249], [418] [417], [248], [249], [419] [449], [450], [248] [538], [248] [552], [553], [248] [590], [248] [538], [248], [249], [418]
249	for	[417], [248], [249], [418] [417], [248], [249], [419] [538], [248], [249], [418]
250	Sorry	
251	Thank you	
252	Messages	[258], [252]
253	days	
254	minutes	
255	seconds	[492], [255]
256	Enter your password, followed by #	[256], [302]
257	Incorrect entry	
258	You have (number)	[258], [259] [258], [252] [258], [608]
259	new messages	[258], [259]
260	You have one new message	
261	You have one message	
262	There are no messages	
263	Sorry, this function is not available	[263], [264]
264	Please inform system manager	[263], [264] [587], [588], [264]
265	Cannot be retrieved	
266	Thank you for calling	
267	Message Manager	
268	Please leave a message at the tone	
269	To end recording, press 1	[269], [270] [391], [269], [270]

List of Modifiable Prompts

Prompt No.	Modifiable Prompt	Linked to Prompt No(s).
270	To pause and restart recording, press 2	[269], [270] [278], [270] [391], [269], [270]
271	Record greeting at the tone	
272	Record the question at the tone	
273	Record the prompt at the tone	
274	Record menu at the tone	
275	Record company name at the tone	
276	Record label at the tone	
277	Sorry, there is no space for recording in this mailbox	
278	To end recording, hang up or press 1 for more features	[278], [270]
279	To end recording, hang up To cancel your message, press *, if you have a touch tone phone	
280	Recording accepted	
281	To review, press 1	[281], [282], [283], [284], [285] [281], [287], [283], [285] [281], [282], [283]
282	To accept, press 2	[281], [282], [283], [284], [285] [305], [282] [328], [282] [281], [282], [283] [453], [282], [442] [328], [282], [479] [328], [282], [482] [328], [282], [442], [581], [582], [583], [584] [328], [282], [442], [581], [582], [583], [584], [585] [328], [282], [601]
283	To erase and try again, press 3	[281], [282], [283], [284], [285] [281], [287], [283], [285] [281], [282], [283]
284	To add, press 4	[281], [282], [283], [284], [285]
285	To erase and exit, press *	[281], [282], [283], [284], [285] [281], [287], [283], [285]
286	Sorry, I cannot add any more	
287	To accept the prompt, press 2	[281], [287], [283], [285]
288	Record the recipient's name at the tone	

List of Modifiable Prompts

Prompt No.	Modifiable Prompt	Linked to Prompt No(s).
289	Sorry, no space for recording	
290	Enter the first 3 or 4 letters of the person's last name	
291	Sorry, this name cannot be found	
292	Sorry, there are no more matching names	[292], [295]
293	To call this person, press 1	[293], [294], [295]
294	To change to the next person, press 2	[293], [294], [295]
295	To try again, press *	[293], [294], [295] [292], [295]
296	Extension (extension number)	
297	Sorry, this mailbox is in use	
298	There were (number of failure)	[298], [299]
299	unsuccessful attempts to enter this mailbox	[298], [299]
300	Password entry failure Check the password	
301	Enter the 4 digits password	[301], [302]
302	To skip setting the password, press #	[301], [302] [256], [302]
303	Password not assigned	
304	This is the general delivery mailbox	
305	To set delivery time or make this message private, press 1	[305], [282]
306	To enter your callback number, press 1	[306], [307]
307	Otherwise, press 2	[306], [307] [313], [307] [359], [328], [307] [381], [307] [385], [307] [389], [328], [307] [433], [307] [350], [307]

List of Modifiable Prompts

Prompt No.	Modifiable Prompt	Linked to Prompt No(s).
308	To set delivery time, press 1 For immediate delivery, press 2	
309	Enter the time, followed by #	[309], [310] [309], [461], [310]
310	For help, press 0	[309], [310] [309], [461], [310] [343], [539], [540], [541], [542], [310]
311	Enter 1 for AM, or 2 for PM	
312	Enter the day of the month, followed by #	
313	To make this message private, press 1	[313], [307]
314	This message will be delivered on (day)	[314], [248]
315	Good morning	[315], [316]
316	Welcome to the Voice Processing System	[315], [316] [317], [316] [318], [316]
317	Good afternoon	[317], [316]
318	Good evening	[318], [316]
319	Please enter your party's mailbox number	[319], [320] [319], [320], [322]
320	To enter by name, press # and 1	[319], [320] [319], [320], [322] [386], [320] [386], [320], [387] [596], [320] [597], [320]
321	If you are using a rotary telephone, stay on the line	[321], [322]
322	To call the operator, press 0	[321], [322] [319], [320], [322]
323	To accept, press 1	[323], [324], [325], [326]
324	For the next name, press 2	[323], [324], [325], [326]
325	To repeat this name, press 3	[323], [324], [325], [326]
326	To enter a new name or mailbox, press *	[323], [324], [325], [326]
327	The mailbox number entry failure Check the mailbox number	

List of Modifiable Prompts

Prompt No.	Modifiable Prompt	Linked to Prompt No(s).
328	To change, press 1	[328], [282] [359], [328], [307] [389], [328], [307] [328], [282], [479] [328], [282], [482] [328], [282], [442], [581], [582], [583], [584] [328], [282], [442], [581], [582], [583], [584], [585] [328], [592] [328], [282], [601]
329	There was one unsuccessful attempt to enter this mailbox	
330	Record your name at the tone	
331	Record the group name at the tone	
332	Record Owner's name at the tone	
333	For example, to enter 5 o'clock press five and #, or to enter 5:15 press 5, 1, 5 and #	
334	This message is from (name)	[334], [335]
335	of (company name)	[334], [335]
336	Delivering message to (name)	
337	Company name (name)	
338	Hello, this is the voice processing system	
339	I have a message for (name)	[339], [340], [341] [339], [340], [341], [351]
340	To receive the message, press 1	[339], [340], [341] [339], [340], [341], [351] [340], [572], [573], [574], [575], [576], [345] [340], [572], [573], [574], [575], [345]
341	To hold this call, press 2	[339], [340], [341] [339], [340], [341], [351]
342	To retrieve the call, press 2	
343	To repeat this message, press 1	[343], [344], [345] [343], [344], [346], [347], [345] [343], [539], [540], [541], [542], [310] [343], [543], [539], [540], [541], [346], [347], [542], [544]

List of Modifiable Prompts

Prompt No.	Modifiable Prompt	Linked to Prompt No(s).
344	To reply, press 2	[343], [344], [345] [343], [344], [346], [347], [345]
345	To end this call, press *	[343], [344], [345] [343], [344], [346], [347], [345] [350], [345] [340], [572], [573], [574], [575], [576], [345] [340], [572], [573], [574], [575], [345]
346	To rewind, press 5	[343], [344], [346], [347], [345] [343], [543], [539], [540], [541], [346], [347], [542], [544]
347	To fast forward, press 6	[343], [344], [346], [347], [345] [343], [543], [539], [540], [541], [346], [347], [542], [544]
348	Please call (telephone number)	
349	Extension number (extension number)	
350	To repeat, press 1	[350], [345] [350], [307]
351	If you want me to call back later, press 3	[339], [340], [341], [351]
352	Welcome to the general delivery mailbox	
353	I have a call for mailbox (mailbox number)	
354	Please wait a moment	[370], [354]
355	Please enter your callback number	[355], [356], [357] [355], [356], [357], [358]
356	You can enter up to (number)	[355], [356], [357] [355], [356], [357], [358]
357	digits	[355], [356], [357] [355], [356], [357], [358]
358	When you are finished hang up, stay on the line to confirm or change your number	[355], [356], [357], [358]
359	The callback number is (telephone number)	[359], [328], [307]
360	Please hold while I page your party	
361	Sorry, this pager is not available	
362	I have a call for (name)	

List of Modifiable Prompts

Prompt No.	Modifiable Prompt	Linked to Prompt No(s).
363	Sorry, no one is available to answer the call	
364	To leave a message, press 1	[364], [382]
365	To reach the covering extension, press 2	
366	To page your party, press 3	
367	To notify your party's beeper, press 4	
368	To enter another extension, press *	
369	Sorry, this number is not assigned	
370	Calling the operator	[370], [354]
371	Call transferred from the voice processing system	
372	Sorry, this line is busy	
373	Sorry, Operator is not available to answer the call Please call back later	
374	You have a call	
375	You have a call from (name)	
376	To answer the call, press 1 Otherwise, press 2 and hang up	
377	This call is for (name)	[377], [378]
378	from (name)	[377], [378]
379	This call is from (name)	
380	To cancel holding, press 2 now Otherwise, I'll try your party again	
381	To continue holding, press 1	[381], [307]
382	To enter another extension, press 2	[364], [382]
383	(number) other people are waiting to connect	
384	One other person is waiting to connect	
385	If you would like to hold, press 1	[385], [307]
386	Please enter your party's extension	[386], [320] [386], [320], [387]
387	For department dialing, press *	[386], [320], [387]

List of Modifiable Prompts

Prompt No.	Modifiable Prompt	Linked to Prompt No(s).
388	Custom service menu	
389	The callback number is not assigned	[389], [328], [307]
390	Message from the system manager	
391	State your comment at the tone	[391], [269], [270]
392	Beeper access disabled	
393	To set call transfer status, press 1 To set up covering extension, press 2 To set message reception mode, press 3 To set incomplete handling status, press 4	
394	Call blocking enabled	
395	Call screening enabled	
396	Intercom paging enabled	
397	Beeper access enabled	
398	All transfer services disabled	
399	To enable call blocking, press 1 To enable call screening, press 2 To enable intercom paging, press 3 To enable beeper access, press 4 To disable all transfer service, press 5	
400	Message reception mode is interview mode	
401	Message reception mode is message recording mode	
402	To set leaving a message status, press 1 To set covering extension transfer status, press 2 To set intercom paging status, press 3 To set beeper access status, press 4 To set operator transfer status, press 5 To set returning to top menu automated attendant service status, press 6	

List of Modifiable Prompts

Prompt No.	Modifiable Prompt	Linked to Prompt No(s).
403	Leaving a message is enabled	
404	Leaving a message is disabled	
405	Covering extension transfer enabled	
406	Covering extension transfer disabled	
407	Intercom paging disabled	
408	Operator transfer enabled	
409	Operator transfer disabled	
410	Returning to top menu automated attendant service enabled	
411	Returning to top menu automated attendant service disabled	
412	(number) messages to verify	
413	One message to verify	
414	No messages to verify	
415	Message for (name)	[415], [416], [248]
416	received on (date)	[415], [416], [248]
417	Message sent on (date)	[417], [248], [249], [419]
418	has not been received	[538], [248], [249], [418]
419	has been erased, because message retention time expired	[417], [248], [249], [419]
420	To play the message, press 1 To check the previous message, press 1 twice To check the next message, press 2	
421	To cancel this message or verification, press 3	
422	No more messages	
423	This is the last message	
424	To delete distribution verification of this message, press 1 To cancel message delivery, press 2	
425	Verification deleted	
426	Message delivery cancelled	
427	The message is (message)	
428	Sorry, this group is full	[428], [429] [428], [526]

List of Modifiable Prompts

Prompt No.	Modifiable Prompt	Linked to Prompt No(s).
429	8 members maximum	[428], [429]
430	This list member already exists	
431	To add more members, press 1 To end, press 2	
432	Telephone number is (telephone number)	
433	To delete all group members, press 1	[433], [307]
434	This group has no members	
435	To delete, press 1	[435], [436]
436	To play the next, press 2	[435], [436]
437	Group member deleted	
438	Enter delivery list number 1 or 2	
439	Delivery list number is (number)	
440	To add new member, press 1	[440], [441], [442]
441	To delete members, press 2	[440], [441], [442]
442	To review, press 3	[440], [441], [442] [453], [282], [442] [328], [282], [442], [581], [582], [583], [584] [328], [282], [442], [581], [582], [583], [584], [585]
443	Sorry, this list is in use for delivery If this list is edited, all the deliveries will then be cancelled.	
444	To record a message for external delivery, press 1 To check external delivery message status, press 2 To set up mailing list, press 3	
445	To send to one recipient, press 1 To send by mailing list, press 2	
446	Sorry, you cannot deliver the message The maximum number of delivery has already been reached	
447	Sorry, there is no space for recording	
448	Password is (number)	

List of Modifiable Prompts

Prompt No.	Modifiable Prompt	Linked to Prompt No(s).
449	External delivery message scheduled for (name)	[449], [450], [248]
450	on (date)	[449], [450], [248]
451	External delivery message will be sent to (name)	[451], [452]
452	right away	[451], [452]
453	To change the setting, press 1	[453], [282], [442]
454	No one specified by this number	
455	To change the telephone number, press 1	[455], [456], [457], [458]
456	To change the password, press 2	[455], [456], [457], [458] [497], [456], [498], [499]
457	To change the recipient's name, press 3	[455], [456], [457], [458]
458	To change the time and date, press 4	[455], [456], [457], [458]
459	To change the password, press 1	[459], [460]
460	To change the time and date, press 2	[459], [460] [471], [460]
461	To deliver now, press only the hash	[309], [461], [310]
462	No external delivery message pending	
463	I was unable to reach (name)	
464	External delivery message for (name)	[464], [465], [466]
465	was erased	[464], [465], [466]
466	because message retention time expired	[464], [465], [466]
467	To reschedule, press 1	[467], [468], [469], [470] [468], [469], [470]
468	To play the next schedule, press 2	[467], [468], [469], [470] [468], [469], [470]
469	To repeat this schedule, press 3	[467], [468], [469], [470] [468], [469], [470]
470	To play the previous schedule, press 4	[467], [468], [469], [470] [468], [469], [470]
471	To cancel external message delivery, press 1	[471], [460]

List of Modifiable Prompts

Prompt No.	Modifiable Prompt	Linked to Prompt No(s).
472	Message to (name)	[472], [473]
473	being delivered now	[472], [473]
474	I'll redial only once	
475	I'll redial (number)	[475], [476]
476	more times	[475], [476]
477	Covering extension is (extension number)	
478	Covering extension not assigned	
479	To delete, press 3	[328], [282], [479]
480	Enter extension number	
481	Group name not recorded	
482	To erase, press 3	[328], [282], [482]
483	Owner's name erased	
484	To record the question, press 1 To set the answer length, press 2 To erase the question, press 3	
485	To change the answer length, press 1	[485], [486], [487], [488]
486	To skip to the next question, press 2	[485], [486], [487], [488] [490], [486], [487], [488] [491], [486], [487], [488] [486], [487], [488]
487	To skip to the previous question, press 3	[485], [486], [487], [488] [490], [486], [487], [488] [491], [486], [487], [488] [486], [487], [488]
488	To go directly to a question, press 4	[485], [486], [487], [488] [490], [486], [487], [488] [491], [486], [487], [488] [486], [487], [488]
489	Set the answer length using the following options For 4 seconds, press 1 For 8 seconds, press 2 For 16 seconds, press 3 For 32 seconds, press 4	
490	To change this question, press 1	[490], [486], [487], [488]
491	To erase this question, press 1	[491], [486], [487], [488]
492	Answer length is (number)	[492], [255]

List of Modifiable Prompts

Prompt No.	Modifiable Prompt	Linked to Prompt No(s).
493	Enter question number, followed by #	
494	Question erased	
495	Question number (number)	
496	No question recorded	
497	To change the personal greeting, press 1	[497], [456], [498], [499]
498	To change the owner's name, press 3	[497], [456], [498], [499]
499	To set the group distribution lists, press 4	[497], [456], [498], [499]
500	To change the message waiting lamp status, press 1 To change the device status, press 2 To assign the telephone or beeper numbers, press 3	
501	Message waiting lamp notification enabled	
502	Message waiting lamp notification disabled	
503	Enter device number, 1 through 3	
504	Device number is (number)	
505	This device is for continuous use	
506	This device is not be used	
507	Telephone number is not assigned	
508	First telephone number is (telephone number)	
509	First telephone number is not assigned	
510	Second telephone number is (telephone number)	
511	Second telephone number is not assigned	
512	Third telephone number is (telephone number)	
513	Third telephone number is not assigned	

List of Modifiable Prompts

Prompt No.	Modifiable Prompt	Linked to Prompt No(s).
514	To change the first telephone number, press 1 To change the second telephone number, press 2 To change the third telephone number, press 3	
515	I'll notify by telephone	
516	I'll notify by beeper	
517	Sorry, you cannot transfer a private message	
518	To change the no answer greeting, press 1 To change the busy signal greeting, press 2 To change the after hours greeting, press 3	
519	No answer greeting is (message)	
520	Busy signal greeting is (message)	
521	After hours greeting is (message)	
522	No answer greeting is not recorded	
523	Busy signal greeting is not recorded	
524	After hours greeting is not recorded	
525	Greeting erased	
526	20 members maximum	[428], [526]
527	Enter the mailbox number	
528	Enter a group number, 1 through 4	
529	Group number (number)	
530	To change the group name, press 1.	[530], [531] [530], [531], [532], [533]
531	To add group members, press 2	[530], [531] [530], [531], [532], [533]
532	To delete group members, press 3	[530], [531], [532], [533]
533	To review this group, press 4	[530], [531], [532], [533]
534	Message from the interview mailbox	

List of Modifiable Prompts

Prompt No.	Modifiable Prompt	Linked to Prompt No(s).
535	Message from the message manager	
536	Message recorded by (mailbox number)	[536], [537], [247]
537	and transferred via (mailbox number)	[536], [537], [247]
538	Message recorded on (date)	[538], [248] [538], [248], [249], [418]
539	To play the next message, press 2	[343], [539], [540], [541], [542], [310] [343], [543], [539], [540], [541], [346], [347], [542], [544] [550], [539], [551]
540	To erase this message, press 3	[343], [539], [540], [541], [542], [310] [343], [543], [539], [540], [541], [346], [347], [542], [544]
541	To reply, press 4	[343], [539], [540], [541], [542], [310] [343], [543], [539], [540], [541], [346], [347], [542], [544]
542	To transfer this message, press 7	[343], [539], [540], [541], [542], [310] [343], [543], [539], [540], [541], [346], [347], [542], [544]
543	To replay the previous message, press 1 twice	[343], [543], [539], [540], [541], [346], [347], [542], [544]
544	To message scan, press 8	[343], [543], [539], [540], [541], [346], [347], [542], [544]
545	No previous message	
546	All messages erased	
547	Message transferred via (mailbox number)	[547], [247]
548	Message erased	
549	These are the brief segments of your Message	
550	To replay the previous message, press 1	[550], [539], [551]
551	To play the entire message, press 3	[550], [539], [551]
552	Message from (name)	[552], [553], [248]
553	was sent on (date)	[552], [553], [248]
554	To replay the previous message information, press 1 To play the next message's information, press 2 To play the message, press 3	

List of Modifiable Prompts

Prompt No.	Modifiable Prompt	Linked to Prompt No(s).
555	You can add up to (number)	[555], [556]
556	more members	[555], [556]
557	Sorry, you cannot reply	[557], [558] [557], [560] [557], [561]
558	The message sender is unknown	[557], [558]
559	To call message sender, press 1 To record a message, press 2	
560	This message is from the general delivery mailbox	[557], [560]
561	This is your message	[557], [561]
562	Telephone number deleted	
563	For notification by telephone, press 1 For notification by beeper, press 2	
564	Old message	
565	New message	
566	Message reception mode is set to interview mode	
567	Message reception mode is set to message recording mode	
568	Group name erased	
569	This device is for scheduled use	
570	Owner's name is (name)	
571	Owner's name is not recorded	
572	To deliver a message, press 2	[340], [572], [573], [574], [575], [576], [345] [340], [572], [573], [574], [575], [345]
573	To check the mailbox distribution, press 3	[340], [572], [573], [574], [575], [576], [345] [340], [572], [573], [574], [575], [345]
574	For automated attendant status, press 4	[340], [572], [573], [574], [575], [576], [345] [340], [572], [573], [574], [575], [345]
575	For mailbox management, press 5	[340], [572], [573], [574], [575], [576], [345] [340], [572], [573], [574], [575], [345]
576	For other features, press 6	[340], [572], [573], [574], [575], [576], [345]
577	For interview mailbox management, press 1	
578	To set up message waiting notification, press 2	

List of Modifiable Prompts

Prompt No.	Modifiable Prompt	Linked to Prompt No(s).
579	Any digit on the telephone keypad can be used	
580	Enter the telephone number and wait To insert a pause or special command, enter the partial number and wait for the options menu	
581	To add more digits, press 4	[328], [282], [442], [581], [582], [583], [584] [328], [282], [442], [581], [582], [583], [584], [585]
582	To insert a pause, press 5	[328], [282], [442], [581], [582], [583], [584] [328], [282], [442], [581], [582], [583], [584], [585]
583	To set dial mode, press 6	[328], [282], [442], [581], [582], [583], [584] [328], [282], [442], [581], [582], [583], [584], [585]
584	To insert a wait for dial tone, press 7	[328], [282], [442], [581], [582], [583], [584] [328], [282], [442], [581], [582], [583], [584], [585]
585	To insert a beeper display command, press 8	[328], [282], [442], [581], [582], [583], [584], [585]
586	You can not add any more digits	
587	Sorry, I cannot call this number	[587], [588], [264]
588	Only extension call is available	[587], [588], [264]
589	For external message delivery, press 3	
590	External delivery message scheduled on (date)	[590], [248]
591	To add, press 2	[328], [591]
592	To use for scheduling, press 1 To use for continuously, press 2 To use not at all, press 3	
593	To transfer, press 1	[593], [594], [595] [593], [604], [594], [595]
594	To add new mailbox number, press 3	[593], [594], [595] [593], [604], [594], [595]
595	To review the mailing list, press 4	[593], [594], [595] [593], [604], [594], [595]
596	Enter your party's mailbox number	[596], [320]
597	Enter the destination mailbox number	[597], [320]

List of Modifiable Prompts

Prompt No.	Modifiable Prompt	Linked to Prompt No(s).
598	To cancel , press * To continue, press 1	
599	Mailbox number already specified	
600	This is your mailbox	
601	To repeat, press 3	[328], [282], [601]
602	Sorry, maximum of 20 destinations exceeded	
603	To record a message, press 1 To add new mailbox number, press 2 To review the mailing list, press 3	
604	To transfer with comment, press 2	[593], [604], [594], [595]
605	To cancel mailing list review, press any key	
606	External delivery message will be sent right away	
607	You have one FAX message	
608	FAX messages	[258], [608]
609	The FAX transfer situation is as follows	
610	Transferred one time	
611	Transferred (number)	[611], [612]
612	times	[611], [612]
613	One attempt was successful	
614	One attempt was busy	
615	One attempt was no answer	
616	(number) attempts were successful	
617	(number) attempts were busy	
618	(number) attempts were no answer.	
619	Selection menu	

List of Modifiable Prompts

[Linked Prompts List]

Subscriber Service

[258] You have (number) [259] new messages	[298] There were (number of failure) [299] unsuccessful attempts to enter this mailbox
---	---

Receive Message

[536] Message recorded by (mailbox number) [537] and transferred via (mailbox number) [247] and (mailbox number)	[547] Message transferred via (mailbox number) [247] and (mailbox number)
[538] Message recorded on (date) [248] at (time)	[258] You have (number) [252] Messages

Message Scan

[552] Message from (name) [553] was sent on (date) [248] at (time)	
--	--

Message Delivery

[314] This message will be delivered on (day) [248] at (time)	
---	--

Personal Group Distribution List

[555] You can add up to (number) [556] more members	
--	--

Check Mailbox Distribution

[415] Message for (name) [416] received on (date) [248] at (time)	[417] Message sent on (date) [248] at (time)
---	---

List of Modifiable Prompts

Check Mailbox Distribution

[249] for (mailbox number) [418] has not been received	[417] Message sent on (date) [248] at (time) [249] for (mailbox number) [419] has been erased, because message retention time expired
---	--

External Message Delivery

[449] External delivery message scheduled for (name) [450] on (date) [248] at (time) [451] External delivery message will be sent to (name) [452] right away	[334] This message is from (name) [335] of (company name) [464] External delivery message for (name) [465] was erased [466] because message retention time expired
[472] Message to (name) [473] being delivered now	[475] I'll redial (number) [476] more times

Message Waiting Notification

[355] Please enter your callback number [356] You can enter up to (number) [357] digits	[355] Please enter your callback number [356] You can enter up to (number) [357] digits [358] When you are finished hang up, stay on the line to confirm or change your number
[377] This call is for (name) [378] from (name)	

Interview Mailbox Management

[492] Answer length is (number) [255] seconds
--

Fax Management

[258] You have (number) [608] FAX messages	[611] Transferred (number) [612] times
---	---

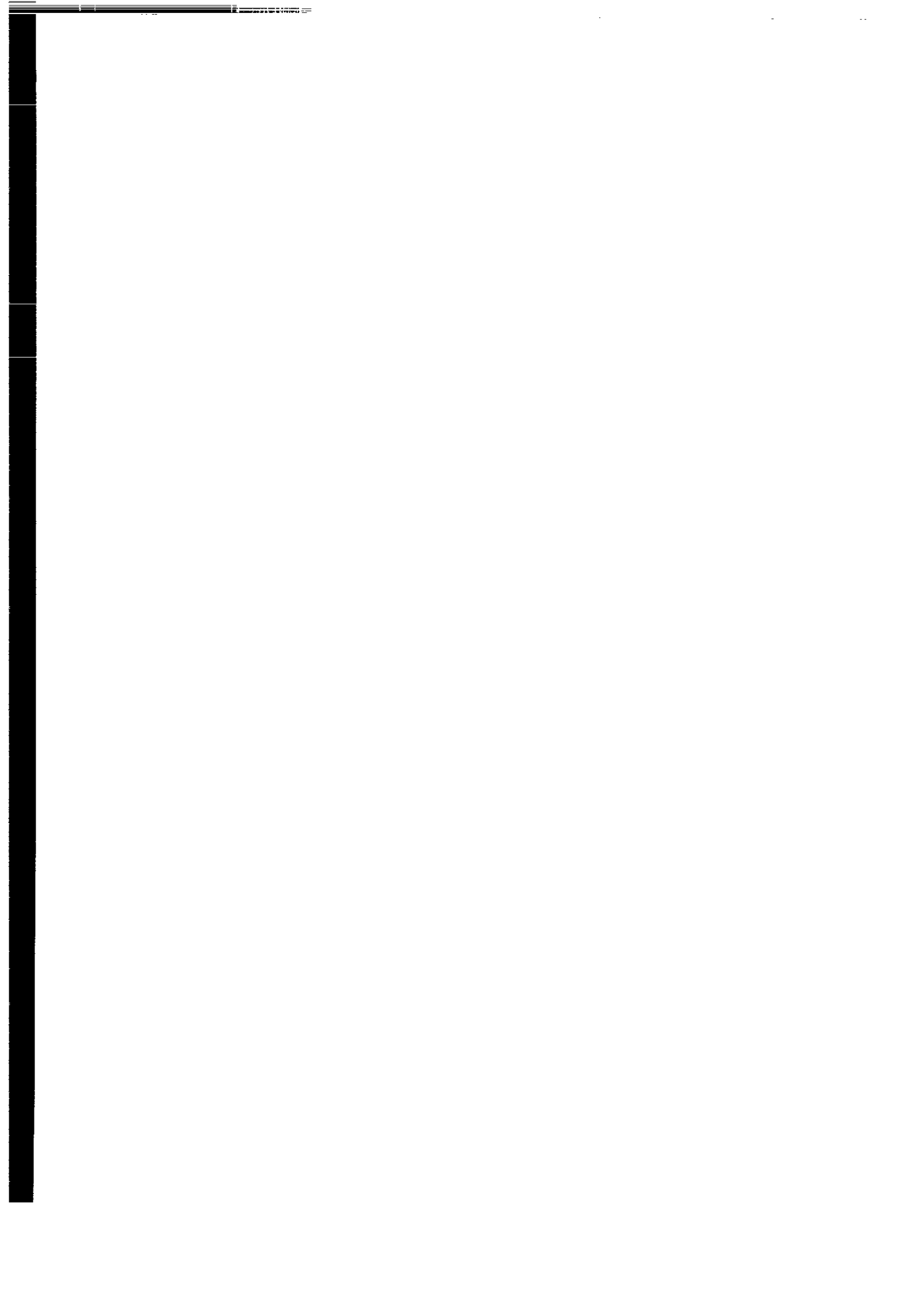

Chapter 7

Maintenance

This chapter explains for the System Administrator about the Utility Commands, System Report, and how to initialize the system so that the VPS can be used effectively. In addition, a troubleshooting guide appears at the end of this chapter.

Contents

7.1 Utility Commands	7-2
7.1.1 Off-line Set (OFLN)	7-2
7.1.2 On-line Set (ONLN)	7-3
7.1.3 Set Password (PASS)	7-3
7.1.4 Set Time (TIME)	7-4
7.1.5 Print Reports at Specified Time (PSET)	7-5
7.1.6 Error Log Display (ELOG)	7-5
7.1.7 Saving the System Data to the Backup Device (SAVE)	7-7
7.1.8 Loading the Saved Data to the VPS (LOAD)	7-9
7.1.9 Print All of the VPS Parameters (GPRN)	7-10
7.1.10 Program Version Display (VERS)	7-10
7.1.11 Custom Service Report (CREP)	7-11
7.1.12 Custom Service Menu Access Count Clear (CCLR)	7-11
7.1.13 Message Waiting Lamp Retry Times (MWL)	7-12
7.1.14 Setting Minimum Recording Length (MRL)	7-12
7.1.15 Modified Prompt List (MPLT)	7-13
7.1.16 Utility Command List (HELP)	7-14
7.1.17 Quick Setup (QSET)	7-14
7.2 System Reports	7-15
7.2.1 Mailbox Assignments	7-15
7.2.2 COS (Class of Service) Assignments	7-16
7.2.3 System Service Report	7-17
7.2.4 Call Account Report	7-18
7.2.5 Port Usage Report	7-18
7.2.6 Disk Usage Report	7-19
7.2.7 Mailbox Usage Report	7-20
7.2.8 Fax Call Report	7-22
7.3 Initializing the System	7-23
7.4 Troubleshooting Guide	7-25

7.1 Utility Commands

In the Utility Command mode, the System Administrator can access the functions described below by entering the appropriate command at the "\$" prompt followed by [RETURN].

System Administration Top Menu → 3

Utility Command (Type 'HELP' for command list.)

\$

OFLN Sets the system to off-line mode
ONLN Sets the system to on-line mode
PASS Sets the System Administrator's password
TIME Sets the system clock, date and time
PSET Specifies the reports printing time
ELOG Displays device error log
SAVE Stores a backup of the program or data on the hard disk
LOAD Restores a backup of the program or data to the system
GPRN Displays all of the VPS parameters
VERS Displays the version of hard disk, main ROM and Port card
CREP Displays the keypad assignments, message recording status and the tree-structure of a Custom service
CCLR Clears a Custom service menu access count
MWL Specifies the number of times the VPS attempts to turn on the message waiting lamp on the extensions
MRL Sets the minimum recording length of a message
MPLT Displays the user prompt recording status
HELP Displays brief instructions and a list of Utility Commands
QSET Sets up your VPS roughly so that you can use it quickly

7.1.1 Off-line Set (OFLN)

Used to turn off the call progressing mode of the VPS.

Set the VPS to off-line mode before deleting a mailbox, since this operation involves the updating of a large number of related parameters.

Type "OFLN", then press [RETURN].

If no VPS ports are in use, the VPS will suspend the call progressing service immediately.

```
S OFLN
** OFF LINE MODE **
```

or

7.1 Utility Commands

If any one of the VPS ports is in use, the VPS will warn you by the following message:

```
*** Now Line is used !! *** <WAIT>
```

After finishing the current operation, the VPS will go to off-line mode.

```
** OFF LINE MODE **
```

7.1.2 On-line Set (ONLN)

Used to restore the call progressing mode of the VPS.

Type "ONLN", then press [RETURN].

```
S ONLN  
** ON LINE MODE **
```

The VPS resumes call progressing service.

7.1.3 Set Password (PASS)

Used to create and change the system passwords in order to ensure system security. Valid passwords can be set using up to eight alphanumeric characters.

- 1 Type "PASS", then press [RETURN].

```
$ PASS  
1: Administrator Password 2: System Reset/Clear Password :=
```

Creating a New Password:

- 2 Select [1] or [2].

```
Maximum 8 characters  
NEW PASSWORD :=
```

- 3 Enter the password.

```
VERIFICATION :=
```

- 4 Enter the password again for verification.

7.1 Utility Commands

Changing a Password:

- 2' Select [1] or [2].

OLD PASSWORD : =

The above is displayed only when changing a password using System Reset/Clear password.

- 3' Enter the current password.

Maximum 8 characters
NEW PASSWORD : =

- 4' Enter the new password.

VERIFICATION : =

- 5' Enter the password again for verification.

- Notes:**
- The password you entered does not appear on the screen for security reason.
 - Pressing [RETURN] instead of entering a password means the password has been reset.
 - The VPS does not distinguish the capital letter from the small letter.

7.1.4 Set Time (TIME)

Used to set the correct system date and time to ensure accurate scheduling. A number of functions require that the system time and date be set correctly in order to operate properly. These include message waiting notification, external message delivery, call-retries-after initial-failure-to-connect, and automatic deletion of messages.

- 1 Type "TIME", then press [RETURN].

S TIME
Current time is 12:34, PM
Enter new time (HH:MM, AM/PM) : =

- 2 Enter the current time.

Current date is AUG-3-1994
Enter new date (MM-DD-YY) : =

7.1 Utility Commands

- 3** Enter the current date.
For the year, type the last two digits.

Note: Enter the exact time and date so that the VPS will function correctly. This command is invalid while the System Manager or the Message Manager is accessing the time setting feature.

7.1.5 Print Reports at Specified Time (PSET)

If a printer or a data terminal is connected to the VPS via the RS-232C port, you can issue the following system reports at the specified time everyday by entering PSET command.

Disk Usage Report / Port Usage Report / Call Account Report

- 1** Type "PSET", then press [RETURN].

```
$ PSET
Report Print Out Service [ Disable ]
1: Enable 2: Disable :=
```

- 2** Press [1] to activate this function.
or
Press [2] to deactivate it.

```
Enter The Print Out Time (HH:MM, AM/PM) :=
```

Enter the time to print the report.

7.1.6 Error Log Display (ELOG)

You can diagnose the VPS by getting the error log of devices such as the CPU card, Port cards and the hard disk.

COM.	Communication error between CPU and Port cards
DATA	Process error of voice data
MEM.	Memory error
PRG.	Program error in CPU card
R/W	Read/Write error of hard disk

7.1 Utility Commands

Type "ELOG", then press [RETURN].

S ELOG		
DEVICE	ERROR	TIME
1. CPU	MEM-GET	JUL-14 14:00 PM
2. CLOCK		JUL-14 14:00 PM
3. DISK	DATA R/W (xx:yyyy)	JUL-14 14:00 PM
4. DSP*	SCAN	JUL-14 14:00 PM
5. DSP*	FIFO	JUL-14 14:00 PM
6. CPU	APPLICATION (x)	JUL-14 14:00 PM

* - Port number

Note: Types of errors displayed on the screen and their meanings are as follows:

Device error log indications

Indication	Meaning
CPU MEM-GET	CPU card software memory acquisition error. CPU card is short of memory temporarily because of too much traffic.
CLOCK	Clock access error. Clock IC is out of order. Check the hardware.
DISK DATA R/W (xx:yyyy)	HDD access error. If there is a sector which often causes errors, check the disk. xx : IDE error code yyyy : read/write error sector number
DSP* SCAN	DSP-SCAN error. DSP is out of order. Check the hardware.
DSP* FIFO	DSP/FIFO error. During the system is handling calls, there is wrong with DSP and FIFO memory temporarily.
CPU APPLICATION (x)	Application error. During the system is handling calls, temporal application error occurs. x: port number

* - Port number (1 - 4)

7.1 Utility Commands

Error indications at system startup

Example terminal display when errors are generated

Indication	Meaning
ROM ERROR : Sum Error!!	ROM checksum error.
DISK ERROR : Initialize Error!!	HDD initialization error.
DISK ERROR : No System!!	No system HDD present.
DISK ERROR : Program Load Error!!	Program could not be loaded from system HDD.
DISK ERROR : Program Sum Error!!	Checksum error in program loaded from system HDD.
DISK ERROR : System Data Error!!	Error loading of administrator data from system HDD.
SYSTEM ERROR : 1	Administrator data error.
SYSTEM ERROR : 2	Error loading of report data.
SYSTEM ERROR : 3	Clock error.
SYSTEM ERROR : 4	Mailbox data error.
SYSTEM ERROR : 5	Message data error (1).
SYSTEM ERROR : 6	Message data error (2).
SYSTEM ERROR : 7	Error loading of control data.
SYSTEM ERROR : 8	Error loading of voice prompt data.
No CO line cards are active!!	No Port cards present.
COs are all Disable!!	All Port cards are malfunctioning.
DPITS Interface Connection is not Established.	Port cards are malfunctioning for DPITS because telephone lines are disconnected or Integration with PBX is not set to D-PITS mode.
SLOT 3 is unavailable for CO card installation!!	SLOT 3 is unavailable for Port card installation.

Error and warning indications during system operation

Indication	Meaning
DISK STORAGE SPACE IS NOW EXCEEDING 80%...	80% or more of the HDD voice message save area is used.
ASCII TERMINAL program Load Error	Error loading of ASCII terminal control program.
VT100 program Load Error	Error loading of VT100 control program.

7.1.7 Saving the System Data to the Backup Device (SAVE)

All system programming data and voice prompts can be backed up in separate data files on a data terminal connected to the RS-232C port of the VPS. You cannot back up all of them at the same time; they must be saved individually.

The SAVE command can be executed for each data file. It may take some time to complete SAVE for all the data. When performing this operation please wait until the process completion indication appears.

7.1 Utility Commands

The memory which is required for the data terminal to be used for this feature is as follows:

1. Program — approximately 1 MBytes
 2. Parameters — approximately 0.3 MBytes
 3. System Prompts — approximately 15 MBytes
 4. User Prompts-1
 5. User Prompts-2
 6. Custom Service Menu
 7. Personal Greeting
- } depending upon the length of the
} recorded messages.

- 1 Type "SAVE", then press [RETURN].

```
S SAVE
VPS Disk Data Save (VPS → PC : Xmodem)
1: Program
2: Parameters
3: System Prompts
4: User Prompts-1
5: User Prompts-2
6: Custom Service Menu
7: Personal Greeting
Select No. :=
```

- 2 Select item to be backed up, then press [RETURN].

```
To start press 'RETURN'
```

- 3 Press [RETURN].

```
Start - - - - Save !!
```

- 4 Set the data terminal to the receiving (Answer) mode (Xmodem). Then specify the backup filename.
The specified data will be transmitted to the data terminal.

- Notes:**
- The data terminal used must be equipped with communications software that supports the Xmodem file transfer protocol.
 - You can cancel this command by pressing '\ ' before entering the receiving mode. Once you have selected the receiving mode, use the cancel command of the communication software which you use. (e.g., "quit" for the Crosstalk)

7.1 Utility Commands

7.1.8 Loading the Saved Data to the VPS (LOAD)

Used to restore the saved data to the VPS in case of disk crash or accidental erasure.

The LOAD command can be executed for each data file. It may take some time to complete LOAD for all the data.

When performing this operation, please wait until the process completion indication appears.

- 1 Type "LOAD", then press [RETURN].

```
$ LOAD
Disk Data Load (PC → VPS : Xmodem)
1: Program
2: Parameters
3: System Prompts
4: User Prompts-1
5: User Prompts-2
6: Custom Service Menu
7: Personal Greeting
Select No.:
```

- 2 Select the item to be restored to the hard disk, then press [RETURN].

```
To start press 'RETURN'
```

- 3 Press [RETURN].

```
Start - - - - - Load !!
```

- 4 Set the data terminal to the sending (Call) mode (Xmodem). Then enter the backup filename.
The backup data will be restored to the hard disk.

- Notes:**
- You can cancel this command by pressing ^\ before entering the receiving mode, and by using the cancel command in the communication software.
 - The data terminal used must be equipped with communications software that supports the Xmodem file transfer protocol.

7.1 Utility Commands

7.1.9 Print All of the VPS Parameters (GPRN)

Prints out all VPS parameter settings (output to screen).

Type "GPRN", then press [RETURN].

```
$ GPRN
0: All Parameters
1: Mailbox Setting
2: Class of Service Setting
3: Port Service Setting
4: Service Setting - Auto. Attn. Setting
5: Service Setting - Custom Service Setting
6: System Parameter Setting - System Group Assignment
7: System Parameter Setting - Day Service, Holiday, Daylight Saving Time
8: System Parameter Setting - Prompt Setting
9: System Parameter Setting - Others
10: Hardware Setting
11: System Reset Clear Parameter

Please select : 1

Program - Mailbox Setting - Mailbox Listing :

MAILBOX No. [101]
1. The Extension of the Owner [108]
2. The Spelling of the Owner First Name [ ]
3. The Spelling of the Owner Last Name [ ]
4. Mailbox Class of Service No. [ 1 ]
5. The Covering Extension [ ]
6. Interview Mailbox Number [ ]
7. All Calls Transfer to Mailbox [ No ]

MAILBOX No. [102]
1. The Extension of the Owner [ ]
  :
```

Note: This command is only valid in the "ASCII terminal" mode.

7.1.10 Program Version Display (VERS)

The version numbers of the hard disk, main ROM and Port card are displayed on the screen.

Type "VERS", then press [RETURN].

```
$ VERS
V.P.S. PROGRAM VERSION

MAIN DISK :
MAIN ROM :
```

7.1 Utility Commands

7.1.11 Custom Service Report (CREP)

Used to display the keypad assignments, message recording status and the tree-structure of a Custom service.

Type "CREP" and Custom service number (1-100), then press [RETURN].

```
$ Crep 20
Custom [20] (User-1) (Access: 3) (Menu Msg. : None)
 | < Custom Service Entry Menu >
 [1]- Xfer Mbx (101)
 [2]- Xfer Extn. (102)
 [3]- Custom [21] (System) (Access: 0) (Menu Msg. : None)
 | | < Voice Mail Information Eng. >
 | | | [1] - Custom [22] (User 2) (Access: 0) (Menu Msg. : None)
 | | | | <Voice Mail Information Spanish >
 | | | | [1]- Operator
 | | | | [2]- Dial by Name
 | | | | [3]- Subscriber
 | | | | [4]- Dprt Dial
 | | | | [*]- Main Menu
 | | [*]- Main Menu
 [6]- Operator
 [7]- Exit
 [8]- Pre.Menu
 [*] Exit
 [#] Main Menu
```

- Custom [20]: Indicates that Custom service No. is "20".
- User-1: Indicates a type of voice prompts is "User-1".
- Access: 3: Indicates that a Custom service was being accessed 3 times by the callers.
- Menu Msg. :None: Indicates that the menu message for a Custom service is "None (not recorded)".
- [1]-Xfer Mbx (101): Indicates that the caller will be transferred to the mailbox 101 by pressing [1].
- [2]-Xfer Extn. (102): Indicates that the caller will be transferred to the extension 102 by pressing [2].

7.1.12 Custom Service Menu Access Count Clear (CCLR)

Used to clear the number of times a Custom service was being accessed by the caller.

7.1 Utility Commands

Type "CCLR", and Custom service number (1-100), then press [RETURN].

```
S CCLR 20
Custom Menu <20> Accessing Counter Cleared !!
```

Note: You can clear the number of access times for all Custom services at once by entering "CCLR 0".

7.1.13 Message Waiting Lamp Retry Times (MWL)

Used to specify the number of times the VPS will attempt to turn on the Message Waiting Lamp of the extension.

This setting is required when your PBX is not a Panasonic KX-T series telephone system.

```
S MWL
Current Setting of M.W.L. Retry Count is 1
Enter M.W.L. Retry Count (1-3) =
```

Note: This setting is not valid if "Message Waiting Lamp for Every Message" is set to "Yes".

7.1.14 Setting Minimum Recording Length (MRL)

Used to specify the minimum recording length (0-3 seconds) of a message. Messages shorter than this setting will be discarded from the mailbox.

Note: You can set the minimum recording length only by using this command.

1 Type "MRL", then press [RETURN].

```
S MRL
Current Setting of Minimum Recording Length is 2
Enter Minimum Recording Length (0-3) =
```

2 Enter your length.

7.1 Utility Commands

7.1.16 Utility Command List (HELP)

The HELP command displays the list of all available utility commands.

- 1 Type "HELP", then press [RETURN].

```
$ HELP
OFLN : System Off-line
ONLN : System On-line
PASS : Password setting
TIME : Time & Date setting
PSET : Report Print Out Time setting
ELOG : Device Error Log Listing
SAVE : VPS Program & Data Save (VPS → PC : Xmodem)
LOAD : VPS Program & Data Load (VPS ← PC : Xmodem)
GPRN : Parameter Global Printing (only 'ASCII Terminal' mode)
VERS : Program Version Check
CREP [no] : Custom Menu Information List
          [no] : Custom Menu No. (1-100)
CCLR [no] : Custom Menu Access Counter Clear
          [no] : Custom Menu No. (1-100/0) (0: Clear All)
MWL [count] : MWL Retry count set (1-3)
MRL [count] : Minimum Recording Length set (0-3)
MPLT [opt] : Registered User Prompt No. List
          [opt] : 1 → User Prompt 1
                : 2 → User Prompt 2
```

7.1.17 Quick Setup (QSET)

Used to set up your VPS very roughly when you use your VPS for the first time or after system initialization.

Type "QSET", then press [RETURN].

You will see the same menu as "Starting the Quick Setup" in Chapter 4. To proceed, go to page 4-8.

7.2 System Reports

The System Administrator can provide eight types of System Reports to monitor the VPS operating status. The reports can be sent via the RS-232C port either to a printer or a terminal. The following eight report options are available.

System Administration Top Menu → 2 → 1

<p>System Reports – System Report Menu</p> <ol style="list-style-type: none">1. Mailbox Assignments2. COS Assignments3. System Service Report4. Call Account Report5. Port Usage Report6. Disk Usage Report7. Mailbox Usage Report8. Fax Call Report <p><u>SELECT ITEM AND PRESS RETURN-KEY</u></p>
--

In addition, the following four reports can be cleared of all values and prepared for use again.

System Administration Top Menu → 2 → 2

<p>System Reports – System Report Clear Menu</p> <ol style="list-style-type: none">1. Port Usage Statistics Clear2. Disk Usage Statistics Clear3. Mailbox Usage Statistics Clear4. Fax Call Report Clear <p><u>SELECT ITEM AND PRESS RETURN-KEY</u></p>
--

7.2.1 Mailbox Assignments

The Mailbox Assignments Report provides information about authorized features for each mailbox, and current settings for mailbox parameters.

7.2 System Reports

System Administration Top Menu → 2 → 1 → 1

*** Mailbox Assignments										Jul-28 11:30 AM ***	
MBOX	Extn.	Name (Fir/Lst)	COS	CExtn.	IVMBOX	ALTrf	MN1st	MN2nd	MN3rd		
510	21	JONE /DELY	2	61	621	-	-	-	-	-	-
511	22	SCHE /----	2	62	611	-	Bep	Tel	-	-	-
512	23	MAY /----	16	63	612	-	Tel	Bep	-	-	-
520	310	JONE/----	1	-	-	X	-	Tel	Bep	-	-
521	320	DAVE/----	1	-	888	-	-	-	-	-	-
522	4100	CLUS ALCC	21	-	-	-	-	-	-	-	-
523	4201	WHIT BLUE	32	-	642	-	-	-	-	-	-

CExtn.: Covering Extension
 ALTrf: All Calls Transfer to Mailbox
 MN2nd: Message Notification Device 2
 Bep: Beeper

IVMBOX: Interview Mailbox
 MN1st: Message Notification Device 1
 MN3rd: Message Notification Device 3
 Tel: Telephone

Note: An 'X' in the screen indicates that the feature marked with the X is set to "Yes".

7.2.2 COS (Class of Service) Assignments

This report provides information on all Class of Service numbers.

System Administration Top Menu → 2 → 1 → 2

*** COS Assignments																	Jul-29 11:30 AM ***				
COS	GL	RtN	RtS	Ln	CaN	CaT	R	O	SI	SP	CW	MC	DM	PG	Pr	MN	ED (pr)	AF (mbox/ dl/ md)			
1	16	10	10	5	10	10	L	N	N	N	N	N	N	1	U1	X	X	U1	-	00:30	M
2	16	7	7	3	10	10	L	Y	N	N	N	N	N	2	U1	X	X	U1	-	00:30	M
3	8	7	7	3	10	10	F	Y	N	N	N	N	N	8	S	X	-	U1	-	00:30	M
.....																					
63	16	30	30	6	100	100	L	N	N	N	Y	Y	1	U1	X	-	U1	-	00:30	M	
64	16	30	30	6	100	100	L	N	N	N	Y	Y	1	U1	-	-	U1	-	00:30	M	

COS: Class of Service Number
 RtN: New Message Retention Time
 Ln: Message Length

GL: Personal Greeting Length
 RtS: Saved Message Retention Time
 CaN: Maximum Messages

7.2 System Reports

CaT: Maximum Message Time
RO: Message Retrieval Order (L = LIFO, F = FIFO)
SI: Message Scanning with Information
SP: Play System Prompt after Personal Greeting
CW: Use Call Waiting on Busy
MC: Message Cancel for Live Call Screening
DM: Direct Mailbox Access
PG: Intercom Paging Group
Pr: Prompt Mode (S = System Prompts, U1 = User 1 Prompts, U2 = User 2 Prompts)
MN: Authorization of Message Waiting Notification
ED (pr) : Authorization of External Message Delivery (Prompt Mode)
AF: Authorization of Auto Forwarding
 (mbox) = Mailbox No. (dl) = Delay Time (md) = Forwarding Mode

Note: An 'X' in the screen indicates that the feature marked with the X is set to "Yes".

7.2.3 System Service Report

The System Service Report provides information about the usable ports of the VPS. It also indicates the services assigned to each VPS port for Day, Night and Holiday modes, the incoming and outgoing call services.

System Administration Top Menu → 2 → 1 → 3

*** System Service Report					Jan-4 7:46 PM ***	
Port	[Day mode]		[Night mode]			
	Grt	Srv	Grt	Srv		
1	1	V.M.	2	A.A.		
2	1	A.A.	2	I.S. (700)		
[Holiday List]						
	Day	Srv	Port	Description		
	DEC-25	C.S.(100)	1,2,3,4	ANNIVERSARY		

Grt: Company Greeting No. **A.A. :** Automated Attendant Service
V.M. : Voice Mail Service **C.S. :** Custom Service **I.S. :** Interview Service

Note: An 'X' in the screen indicates that the feature marked with the X is used.

7.2 System Reports

7.2.4 Call Account Report

The VPS can maintain information on up to 84 outgoing calling sequences for accounting and billing purposes. The outgoing calling information includes the mailbox numbers which have executed outgoing calls, the telephone numbers, call dates and duration times. Note that when the number of outgoing calling sequences approaches 84, this information is automatically sent to the terminal.

System Administration Top Menu → 2 → 1 → 4

*** Call Account						NOV-14 3:40 PM ***
MBOX:111	JAN-4	7:46	PM	00:01:32	DIAL:4312111	
MBOX:116	JAN-7	2:26	PM	00:03:32	DIAL:039814809	
MBOX:114	JAN-7	5:06	PM	00:02:45	DIAL:2612601	
MBOX:118	JAN-8	9:07	AM	00:01:15	DIAL:4312111	
MBOX:112	JAN-8	10:24	AM	00:04:51	DIAL:4312111	

7.2.5 Port Usage Report

The Port Usage Report provides information about port usage and allows you to measure traffic on the system and ports. It includes the accumulated duration times of incoming and outgoing calling services and the total connect time for each port.

System Administration Top Menu → 2 → 1 → 5

*** Port Usage Report					Jan-4 7:46 PM ***
FROM : : APR-10 9:53 AM					
PORT	ED	MN	Rcv	Connect Time	
1	8	0	84	02:20:19	
2	1	0	21	00:18:54	
3	-	-	-	--	
4	-	-	-	--	
Total	9	0	105	02:39:13	
Full-line Time 00:36:39					

ED: External Delivery

MN: Message Notification

7.2 System Reports

Port Usage Statistics Clear

The Port Usage Report can be cleared of all values and prepared for use again.

System Administration Top Menu → 2 → 2 → 1

```
System Reports - System Report Clear - Port Usage Statistics Clear
```

```
May I clear a port usage report data? (Y/N) : =
```

Enter Y (yes) or N (no) and press [RETURN].

If you enter Y, the system will clear the data, so please wait until "Port Usage Report Data Cleared!!" appears.

7.2.6 Disk Usage Report

The Disk Usage Report indicates the amount of disk storage in use and availability in minutes. It also provides the following three statistics:

- Accumulated number of messages which were recorded by callers after last clearing the disk usage.
- Accumulated number of messages deleted by Subscribers.
- Accumulated number of messages expired and removed by the system.

System Administration Top Menu → 2 → 1 → 6

```
*** Disk Usage Report
```

```
Jan-4 7:46 PM ***
```

```
Drive      Avail  Used (%)
  1         284min. 3min. (1)
```

```
FROM : : APR-10 9:53 AM
```

```
MSGs      New    Cpy    Del    Exp
          64     0     6     1
```

Cpy: Copy (Transfer)

Del: Deleted

Exp: Expired

Note: All indications on the report can be reset to zero with the Disk Usage Clear command.

7.2 System Reports

Disk Usage Statistics Clear

The Disk Usage Report can be cleared of all values and prepared for use again.

System Administration Top Menu → 2 → 2 → 2

System Reports – System Report Clear – Disk Usage Statistics Clear

May I clear a disk usage report data ? (Y/N) : =

Enter Y (yes) or N (no) and press [RETURN].

If you enter Y, the system will clear the data, so please wait until "Disk Usage Report Data Cleared!!" appears.

7.2.7 Mailbox Usage Report

The Mailbox Usage Report provides information about the usage of a specific mailbox. It includes the number of recorded messages, the total amount of outgoing calling time and external message delivery, message notification and group message delivery.

System Administration Top Menu → 2 → 1 → 7

Enter the Range : = 111

Note: Specify the range or the mailbox number. To get the information about mailboxes from No. 200 to No. 209, enter "20*" or "200, 209" and press [RETURN].

7.2 System Reports

*** Mailbox Usage Report		Jan-4 7:46 PM ***			
MBOX:111 [JONE BLUE]					
New	MSGs	4			
Received	MSGs	6			
ED	MSGs	0			
FROM ::	Apr-10 9:53 AM				
MBOX Use Time	01:21:30				
Feature Usage	ED	MN	IM	GM	AF
	11	31	20	14	22
Outcalling	LD	Lcl	Beep	Extn.	
(Time)	6	13	0	28	
	00:05:10	00:10:45	00:00:00	00:31:21	
MSG Received	Rcv	Del	Exp		
	42	30	11		

IM: Interview Message

GM: Group Message

LD: Long Distance

Lcl: Local

Exp: Expired

Mailbox Usage Statistics Clear

The Mailbox Usage Report can be cleared of all values and prepared for use again.

System Administration Top Menu → 2 → 2 → 3

System Reports – System Report Clear – Mailbox Usage Statistics Clear

Enter the Range : =

May I clear a mailbox usage report data ? (Y/N) : =

Enter Y (yes) or N (no) and press [RETURN].

If you enter Y, the system will clear the data, so please wait until "Mailbox Usage Report Data Cleared!!" appears.

7.2 System Reports

7.2.8 Fax Call Report

The Fax Call Report provides information about fax transfer status when the VPS receives a fax signal. It includes the fax data receiving date, the port number used, and the fax transfer status for up to 64 fax data.

System Administration Top Menu → 2 → 1 → 8

*** Fax Call Report		NOV-14 3:50 PM ***		
[DATE/TIME]	[PORT]	[FAX-1]	[FAX-2]	
JAN-11 11:15 AM	1	connect	-	
MAR-01 07:58 PM	2	(busy)	(no-ans.)	
APR-04 10:23 AM	4	(busy)	connect	
.....				

no-ans. :No-answer FAX-1: Main Fax Machine FAX-2: Alternate Fax Machine

Fax Call Statistics Clear

The Fax Call Report can be cleared of all values and prepared for use again.

System Administration Top Menu → 2 → 2 → 4

System Reports - System Report Clear - Fax Call Statistics Clear
May I clear a fax call usage report data ? (Y/N) : =

Enter Y (yes) or N (no) and press [RETURN].

If you enter Y, the system will clear the data, so please wait until "Fax Call Report Data Cleared!!" appears.

7.3 Initializing the System

By initializing the system, all messages and mailboxes are cleared and the system parameters are set to the default setting.

- 1 Go to System Administration Top Menu.

```
1 : Program
2 : System Reports
3 : Utility Command
4 : System Reset/Clear
5 : Quick Setup

SELECT ITEM AND PRESS RETURN-KEY
```

Note: "5: Quick Setup" in the above screen does not appear in the ASCII TERMINAL mode.

- 2 Press [4] for System Initialization.

```
System Reset/Clear Menu
Mailbox No. Length : 3
System Manager's Mailbox No. : 999
Message Manager's Mailbox No. : 998

Will you change the settings ? (Y/N) : =
```

- 3 Press [Y] (this moves the VPS to the off-line mode).

```
System Reset/Clear Menu
Mailbox No. Length : 3
System Manager's Mailbox No. : 999
Message Manager's Mailbox No. : 998

Reset System Parameters : press "\"
```

7.3 Initializing the System

- 4 Press [N] to start the system resetting.

System Initializing

•
•
•

- 5 When system initializing ends, the following display will appear on the screen:

>

- Notes:**
- The execution time for System Reset/Clear may differ each time because of the system's capacity and its programs. Generally, it will take at least three minutes.
 - To set the system clock (date and time), use the Utility Command TIME. See page 7-4.

7.4 Troubleshooting Guide

PROBLEM	PROBABLE CAUSE	POSSIBLE SOLUTION
The VPS does not operate.	<ul style="list-style-type: none"> • Bad printed circuit board. • Bad connection with PBX. • Card was inserted into the wrong slot. • Incomplete card insertion. 	<ul style="list-style-type: none"> • Change the printed circuit board. • If the phone works properly when SLT is connected instead of the VPS, change the Port card. If the phone still fails to work properly, check the connection between the VPS and PBX. • Insert the card firmly into the normal card slot. • Insert the card firmly into the back board.
<ul style="list-style-type: none"> • Dialing is not registered. 	<ul style="list-style-type: none"> • A pulse phone is being used by mistake. • Improper setting of integration mode. 	<ul style="list-style-type: none"> • Change to a touch-tone phone. • Adjust the integration mode properly between the VPS and your PBX.
<ul style="list-style-type: none"> • Line disconnection occurs while transferring an outside call. • Outside calls cannot be transferred. 	<ul style="list-style-type: none"> • Improper setting of the transfer sequence. • Improper setting of the hooking time. • Improper setting of the CPC signal. 	<ul style="list-style-type: none"> • Adjust the transfer sequence to that of the connected PBX and reset. • Adjust the hooking time to that of the connected PBX and reset. • Adjust the CPC signal to that of the connected PBX and reset.
<ul style="list-style-type: none"> • Unable to make outside calls. 	<ul style="list-style-type: none"> • Improper setting of the outside call dial mode. • Improper setting of the outside call dial procedure. 	<ul style="list-style-type: none"> • Reset the outside call dial mode (tone/pulse) properly. • Reset the outside line access sequence of the connected PBX.
<ul style="list-style-type: none"> • Unable to call an extension. 	<ul style="list-style-type: none"> • Improper setting of extension numbering plan. 	<ul style="list-style-type: none"> • Adjust the extension numbering plan properly.
<ul style="list-style-type: none"> • Unable to access the mail box. 	<ul style="list-style-type: none"> • Improper setting of the number of digits in the mailbox number. 	<ul style="list-style-type: none"> • Readjust the number of digits in the mailbox number.
<ul style="list-style-type: none"> • Connected terminal (RS-232C port) does not operate. 	<ul style="list-style-type: none"> • Improper connection. • Improper setting of the parameter. 	<ul style="list-style-type: none"> • Connect the cable firmly. • Adjust the terminal parameter to the VPS parameter. If the terminal still fails to operate properly, set to the desired parameter from the terminal.
<ul style="list-style-type: none"> • Unable to make reconnection when the line is busy. 	<ul style="list-style-type: none"> • Improper setting of the busy signal reconnection procedure. 	<ul style="list-style-type: none"> • Readjust the busy signal reconnection procedure to that of the connected PBX.
<ul style="list-style-type: none"> • Unable to make a no-response reconnection. 	<ul style="list-style-type: none"> • Improper setting of the no-response reconnection procedure. 	<ul style="list-style-type: none"> • Readjust the no-response reconnection procedure to that of the connected PBX.



Specifications

Port	2 to 4 SLT extensions or D-PITS compatible	
Dialing Method	Tone/Pulse (10pps)	
Flash Time	100 msec (programmable)	
CPC Detection	6.5/150/300/450/600 msec (programmable)	
Type of Line	Loop start min. Loop Current: 20 mA min. Line Voltage: 7 VDC min. Ringing Voltage: 40 VAC	
Extension Numbering	2 to 5 digits (programmable)	
Pause Time	1 to 9 sec (programmable)	
Message Waiting Lamp	Programmable DTMF sequence, Data line of PITS interface	
Main CPU	16-bit microprocessor	
Capacity for Hard Disk	6 hours	
Number of Mailboxes	Max. 64	
Number of Messages	Max. 100 per mailbox (programmable)	
Personal Greeting Message Length	8 to 60 sec (programmable)	
Message Retention Time	1 to 30 days, or unlimited (programmable)	
Maximum Message Length	1 to 6 min. (programmable)	
Reports	Mailbox List, Class of Service List, System Service Report, Call Account Report, Disk Usage Report, Port Usage Report, Mailbox Usage Report, FAX Report	
Connections	Telephone Line	Modular connectors × 2 (max. 4) 2-conductor wire × 2 (max. 4) 4-conductor wire with D-PITS interface × 1 (max. 2)
	Data Port	RS-232C interface port
Power Source	230-240VAC, 50Hz	
Dimensions	468 × 327 × 101 mm (18-7/16" × 12-7/8" × 4")	

Index

A

- Alternate extension 3-3, 4-48
- Auto configuration 3-3
- Auto forwarding 3-3, 3-35, 4-34, 5-10
- Automated attendant service 3-4, 3-31, 3-43

B

- Backup, system data 7-7
- Baud rate 4-76
- Broadcasting messages 3-7
 - delivering 5-14
- Busy coverage mode 3-7, 3-46

C

- Callback number entry 3-7
- Call blocking 3-11
- Call queuing announcement 4-70
- Call retrieval announcement 4-70
- Call screening 3-10
- Call services 3-9
- Call transfer status 3-10
- Call transfer, all calls to a mailbox 3-33
- Call waiting on busy 4-29, 5-8
- Card:
 - CPU 2-4, 7-5
 - Port 2-4, 7-5
- Class of service 3-12, 4-27, 5-7
 - assign number of 4-21, 5-5
- Clock 3-54, 5-11, 6-11, 7-4
- Company greeting 3-12
 - assign number of 4-38
 - recording 6-12
- Company name, recording 6-12
- Company's telephone number 4-69
- Covering extension 3-13, 4-21
- CPC signal 4-78, 7-25

- Custom service 3-13, 3-31, 3-44, 3-58, 4-50
 - recording menu of 6-14
 - report 7-11

D

- Data terminal 2-15
- Day service 3-19, 4-57
 - time set 4-58
- Daylight saving time 3-19, 4-61, 5-11
- Delayed answer time 4-38
- Department dialing 3-19, 4-40
 - recording menu of 6-13
- Dialing by name 3-20
- Dialing parameters 4-78
- Digit translation table 4-85
- Direct mailbox access 3-21, 3-51, 4-29, 5-9
- Disconnect parameter 4-75
- D-PITS 3-21

E

- Extension group 3-22, 3-41, 4-55
- Extension number, assign 4-21, 5-5
- Extension numbering plan 3-22, 4-63
- External message delivery 3-22, 4-34, 4-68, 5-10
 - checking of 3-24
- External message delivery list 3-22

F

- Fax management 3-24, 4-73
- Flash time 4-77

G

- General delivery mailbox 3-34, 6-5
- Group distribution list, personal 3-25, 3-36, 3-38
- Group distribution list, system 3-25, 3-36
 - 3-38, 4-53, 5-15
- recording label of 6-15

H

- Hard disk drive 2-5, 7-5
- Hold 3-26, 3-30, 4-70
- Holiday service 3-19, 3-26, 4-58

I

- Inband 3-26, 4-81
- Inband signaling parameters 4-83
- Incoming call services 3-9, 3-49, 4-38
- Incomplete call handling service 3-29
- Initialization, of system 7-23
- Intercom paging 3-11, 3-29, 4-71
 - group assignment 4-30, 5-9
- Interview mailbox 4-21, 5-5
 - assign number of 4-38
- Interview service 3-31, 3-44

L

- Live call screening 3-32
 - message cancel for 4-29, 5-9
- Log, error 7-5
- Logical extension 3-33

M

- Mailbox 3-33
 - delete 4-25, 5-6
 - general delivery *See General delivery mailbox*
 - interview *See Interview mailbox*
 - setup 4-19, 5-4
 - subscriber's *See Subscriber's mailbox*
 - system manager's *See System manager's mailbox*
 - message manager's .. *See Message manager's mailbox*
- Mailbox capacity 3-35, 4-28, 5-7
- Mailbox group *See Group distribution list, system*
- Message:
 - broadcasting 3-7, 5-14
 - private 3-36, 3-50
- Message delivery:
 - to subscribers 3-36, 5-14
 - to non-subscribers *See External message delivery*
 - checking of 3-24, 3-36, 5-15

Message length:

- maximum 4-28
 - minimum 7-12
- Message listening 3-50, 5-17
 - from general delivery mailbox 6-5
 - Message manager's mailbox 3-34, 6-3, 7-23
 - Message reception mode 3-37
 - Message recording 3-51
 - Message retention time 4-28, 5-7
 - Message retrieval order 4-28, 5-8
 - Message scan 3-37, 3-50
 - with information 4-28, 5-8
 - Message transfer 3-38, 3-50, 6-6
 - Message waiting notification 3-38, 4-66
 - authorization of 4-33, 4-35, 5-9
 - notification numbers 4-23, 6-8
 - via device 3-7, 3-38, 4-22
4-33, 4-67, 6-7
 - via lamp 3-41, 6-7, 7-12
 - Multi-lingual service 3-42

N

- No-answer coverage mode 3-46
- No-answer time 4-69

O

- Operator service 3-46, 3-52
 - assign extension of 4-42, 6-10
- Outgoing call setup sequence 4-66
- Outside line, number of digit to access 4-65

P

- Password:
 - delete 5-6
 - enter 5-3, 6-3
 - set 5-16, 6-10, 7-3
- Password, of external delivery message 3-23
- Pause time 4-65
- PBX integration 3-47
- PBX interface parameters 4-78

Personal greeting	3-48
length	4-28, 5-7
play system prompt after	3-49, 4-29, 5-8
Port service	3-31, 3-49
Program version display	7-10
Prompt for rotary callers	4-38
Prompt, linked	3-58, 6-40
Prompt, modifiable	6-18
Prompt list, modified	7-13
Prompt mode	3-43
for incoming calls	4-38
in custom service	4-51
in subscriber service	4-30, 5-9
Prompt selection number	4-62

Q

Quick setup	4-3, 4-8
-------------------	----------

R

Reply to message sender	3-51
Rotary telephone service	3-52, 4-71
RS-232C parameters	4-76

S

Selection menu	3-42
recording	6-16
Service access commands	3-53
Special feature authorization	3-53, 4-32, 5-9
Subscriber's mailbox	3-33
Subscriber's name:	
spelling of	5-5
voiced	5-4
System callback number	3-7, 4-69
System manager's mailbox	3-34, 5-3, 7-23
System prompt	3-42, 3-58
System reports	3-54, 5-12, 7-15

T

Time stamp, position of	4-63
Two-way recording	3-55

U

User prompt	3-42, 3-58
recording	6-15
Utility commands	3-56, 7-2

V

Voice mail service	3-31, 3-43, 3-56
Voice prompts	3-58

Worksheets

Introduction

This manual consists of questionnaires and worksheets. To set up your Voice Processing System (VPS) to operate properly, some preparation is required. First, check up on your existing telephone system using the questionnaires. Second, fill in the worksheets with the data which you wish to set. If you do these things beforehand, actual input operation goes quicker and smoother.

Contents	2 ~ 3
How to Use the Worksheets	4 ~ 5
Planning the Application	W-0-1 ~ W-0-7
Worksheets for System Administrator	W-1-1 ~ W-1-32
Worksheets for System Manager	W-2-1 ~ W-2-5
Worksheets for Message Manager	W-3-1 ~ W-3-10

Note: If necessary, please make a photo copy from original worksheets.
--

Contents

Introduction	1
How to Use the Worksheets	4
Planning the Application	W-0-1
Background Information	W-0-2
Switch Capabilities	W-0-2
Customer's Call Handling Survey	W-0-6
Worksheets for System Administrator	W-1-1
Mailbox Settings	W-1-2
Notification Setting	W-1-3
Class of Service Setting	W-1-4
Special Feature Authorization	W-1-5
Port Assignment	W-1-6
Department Dialing	W-1-7
Operator's Parameters	W-1-8
Alternate Extension Assignment	W-1-11
Custom Service	W-1-12
Mailbox Group	W-1-13
Extension Group	W-1-14
Day Service	W-1-15
Holiday Setting	W-1-16
Daylight Saving Time	W-1-17
Prompt Setting	W-1-18
Extension Numbering Plan	W-1-19
Dialing Parameters	W-1-20
Message Waiting Notification Parameters	W-1-21
External Message Delivery Parameters	W-1-22
Call Hold	W-1-23
Rotary Telephone Service	W-1-24
Intercom Paging Parameter	W-1-25
Fax Management	W-1-26
Disconnect Parameter	W-1-27
RS-232C Parameters	W-1-28
Port Setting	W-1-29
Dialing Parameters	W-1-30
Inband Signaling Parameters	W-1-31
Digit Translation Table Parameters	W-1-32

Contents

Worksheets for System Manager	W-2-1
Setting System Manager's Password	W-2-2
Mailbox Settings	W-2-3
Class of Service Setting	W-2-4
Worksheets for Message Manager	W-3-1
Message Manager's Password	W-3-2
Mailbox Owner's Address	W-3-3
Company Greetings	W-3-4
Company Name	W-3-5
Department Dialing	W-3-6
Custom Service Menus	W-3-7
Mailbox Distribution Group Name	W-3-8
Modifying Voice Prompt	W-3-9
Selection Menu	W-3-10

How to Use the Worksheets

Use the worksheets to set the VPS parameters. If you have filled in the worksheets with the values which you wish to set beforehand, the actual input operation goes quicker and smoother.

The top of each worksheet shows how to reach the setting screen with key names in the System Administrator's worksheets and with key numbers in the System Manager's and the Message Manager's worksheets.

Example for System Administrator

System Administration Top Menu → 1 → 4 → 1

Indicates that:

Press [1] in the System Administration Top Menu.

You will see the next menu.

Press [4].

You will see the next menu.

Press [1].

Now the menu described on the worksheet will appear on the screen (Two types of screen: VT100 compatible terminal and ASCII terminal). Enter the values according to the worksheets.

Example for System Manager

System Manager Top Menu → [6] → [1]

Indicates that:

Enter the System Manager's Mailbox number after accessing Voice Mail Service.

You will hear the VPS guidance.

Press .

You will hear the VPS guidance.

Press .

Now enter the values according to the worksheets.

How to Use the Worksheets

Example for Message Manager

Message Manager Top Menu → [5] → [1]

Indicates that:

Enter the Message Manager's Mailbox number after accessing Voice Mail Service.

You will hear the VPS guidance.

Press .

You will hear the VPS guidance.

Press .

Now enter the values according to the worksheets.

Example for Reference

See pages 4-27 – 4-31.

Indicates that:

Refer to pages 27 to 31 in Chapter 4 of the "Installation Manual".



Planning the Application

For installing the VPS, getting information about the existing telephone system and the needs of the customer's company is helpful.

Contents

Background Information	W-0-2
Switch Capabilities	W-0-2
Customer's Call Handling Survey	W-0-6

■ **Background Information**

Switch Make: _____ Model: _____

Software: _____

Manufacturer Contact: _____

Phone: _____

Company Name: _____

Phone: _____

Contact Name: _____

Title: _____

Date: _____

■ **Switch Capabilities**

Can the switch provide support for single line sets? YES / NO

Can the switch provide for CO trunks? YES / NO

a) Ground Start YES / NO

b) Loop Start YES / NO

c) E & M YES / NO

d) DID YES / NO

Can the switch provide End to End DTMF signaling? YES / NO

a) for Single Line sets YES / NO

b) for Digital sets YES / NO

c) for Attendant Console YES / NO

Can the switch provide Call Transfer? YES / NO

a) "Hook-flash" Transfer YES / NO

b) "Feature access code" Transfer YES / NO

c) "Automatic" Transfer (dialing while connected initiates transfer) YES / NO

d) "Blind" Transfer to the Operator YES / NO

e) "Supervised" Transfer to the Operator YES / NO

- f) "Blind" Transfer to any station YES / NO
 - g) "Supervised" Transfer to any station YES / NO
- Standard Ring Generation (min. 40Vrms ... @ 25Hz) YES / NO
- If NOT, can a Standard Ring Generator be added? YES / NO

What is the Frequency and Duration of the Switch Busy Tone? _____

- Can the Switch provide forwarding capabilities? YES / NO
- a) a station that is Busy YES / NO
 - Is CALLED party information (inband DTMF signaling) passed? YES / NO
 - Is CALLING party information (inband DTMF signaling) passed? YES / NO
 - b) a station that does NOT ANSWER YES / NO
 - Is CALLED party information (inband DTMF signaling) passed? YES / NO
 - Is CALLING party information (inband DTMF signaling) passed? YES / NO
 - c) a station that is BUSY or does NOT ANSWER YES / NO
 - Is CALLED party information (inband DTMF signaling) passed? YES / NO
 - Is CALLING party information (inband DTMF signaling) passed? YES / NO
 - d) a station at all times (All Call Forwarding) YES / NO
 - Is CALLED party information (inband DTMF signaling) passed? YES / NO
 - Is CALLING party information (inband DTMF signaling) passed? YES / NO
 - e) Internal Stations ONLY (digital and Single Line sets) YES / NO
 - Is CALLED party information (inband DTMF signaling) passed? YES / NO
 - Is CALLING party information (inband DTMF signaling) passed? YES / NO

- f) External Stations ONLY (trunks) YES / NO
 - Is CALLED party information (inband DTMF signaling) passed? YES / NO
 - Is CALLING party information (inband DTMF signaling) passed? YES / NO

- Can the Switch provide Message Waiting Notification from a Single Line set? YES / NO
 - a) Turn ON any Message Waiting Indicator? YES / NO
 - What is the "ON" sequence? _____
 - b) Turn OFF any Message Waiting Indicator? YES / NO
 - What is the "OFF" sequence? _____

- Type of Message Waiting Notification provided YES / NO
 - a) Message Waiting Indication via (Digital Display) YES / NO
 - b) Message Waiting Indication via (Lamp) YES / NO
 - c) Message Waiting Indication via (Stutter dial tone) YES / NO

- When a station calls another (single line) station (station to station)
 - a) is CALLING party information (inband DTMF signaling) passed? YES / NO
 - b) is "speed dialing" supported by this switch? YES / NO
 - c) can it be programmed to provide CALLING party info via DTMF signaling? YES / NO

- If far end disconnect signaling supported? YES / NO
 - a) Can the Switch provide "open loop current" when the far end disconnects? YES / NO
 - b) Can the Switch provide "silence" when the far end disconnects? YES / NO
 - c) Can the Switch provide a "constant tone" when the far end disconnects? YES / NO
 - (i.e. dial-tone or equivalent ... a minimum of 10 seconds is required)
 - d) Can the Switch provide a DTMF sequence when the far end disconnects? YES / NO
 - if so, what is the sequence? _____

- Can the Switch support any of the following types of Hunt groups? YES / NO
- a) special Voice Mail Hunt Groups YES / NO
 - b) Pilot Hunt Groups YES / NO
 - c) Circular Hunt Groups YES / NO
 - d) UCD Hunt Groups YES / NO
 - e) ACD Hunt Groups YES / NO
 - f) If a forwarding method that would "emulate" Hunt Groups exists,
please describe: _____

Does the Switch provide for attendant overflow positions
to single line stations? YES / NO

Does the Switch provide any special feature that might relate to the
functionality of either voice mail or auto attendant? YES / NO

■ **Customer's Call Handling Survey**

Who attends incoming calls? _____

Who are the customer's callers? _____

Does the attendant spend a lot of time answering repetitive questions? YES / NO

What happens when the operator is not available to answer incoming calls?

How do callers know the extension number?

When a call is transferred, what happens if the extension is busy or does not answer?

- a) Performs paging YES / NO
- b) Talks messages YES / NO
- c) Returns to attendant YES / NO

Are there a lot of calls?

- a) for departments YES / NO
- b) for extensions YES / NO

What kind of messages do callers leave?

- a) Callers name YES / NO
- b) Private message YES / NO
- c) Detailed information YES / NO

Are there any employees sharing extensions? YES / NO

How many outside employees do not have extensions? _____

How many employees use pagers? _____

What are peak calling times? _____

Are after hours call answered by an answering machine? YES / NO

Does the Customer require the VPS for

- | | |
|------------------------------|----------|
| a) Main Receptionist | YES / NO |
| b) Call Routing | YES / NO |
| c) Backup Receptionist | YES / NO |
| d) Out of Hours Receptionist | YES / NO |
| e) Custom Service | YES / NO |



Worksheets for System Administrator

Contents

Mailbox Settings	W-1-2
Notification Setting	W-1-3
Class of Service Setting	W-1-4
Special Feature Authorization	W-1-5
Port Assignment	W-1-6
Department Dialing	W-1-7
Operator's Parameters	W-1-8
Alternate Extension Assignment	W-1-11
Custom Service	W-1-12
Mailbox Group	W-1-13
Extension Group	W-1-14
Day Service	W-1-15
Holiday Setting	W-1-16
Daylight Saving Time	W-1-17
Prompt Setting	W-1-18
Extension Numbering Plan	W-1-19
Dialing Parameters	W-1-20
Message Waiting Notification Parameters	W-1-21
External Message Delivery Parameters	W-1-22
Call Hold	W-1-23
Rotary Telephone Service	W-1-24
Intercom Paging Parameter	W-1-25
Fax Management	W-1-26
Disconnect Parameter	W-1-27
RS-232C Parameters	W-1-28
Port Setting	W-1-29
Dialing Parameters	W-1-30
Inband Signaling Parameters	W-1-31
Digit Translation Table Parameters	W-1-32

Mailbox Settings

COS : Class of Service Number
 CExtn. : Covering Extension
 IMBox : Interview Mailbox
 AITrf : All Calls Transfer to Mailbox

See pages 4-19 – 4-22.
 System Administration Top Menu → 1 → 1 → 1 → 1 → Mailbox No.

Mbx No. 2-5 digits	Extn. No. 2-5 digits	Mailbox Owner's Name		COS 1-64 (* 1)	CExtn. 2-5 digits	IMBox 2-5 digits	AITrf 1: Yes 2: No*
		First Up to 16 characters	Last Up to 16 characters				

* : Default
 Note : Please make photo copies of this sheet if necessary.

Notification Setting

See pages 4-22 – 4-24.
 System Administration Top Menu → 1 → 1 → 1 → Mailbox No. → 2 → Device No.

Mbx No.	Phone Number for Message Notification		Use Device 1: Not Use 2: Continuously* 3: Scheduled	Number of Retries 0-4 times (* 0)	Busy Delay 2-120 min. (* 3)	No Answer Delay 2-120 min. (* 30)	Time frame 1, 2 MON - SUN 1-12: hour, 00-59: minute AM/PM: a.m./p.m. *: All Day, Space: No Use
	Number to Dial (Up to 32 digits) 0-9, *, #, P (Pause), T (Dial Tone Detection), M (Dial Mode), X (Callback Number Entry Code)	Type Telephone*/ Beeper					
	1st 2nd 3rd						
	1st 2nd 3rd						
	1st 2nd 3rd						
	1st 2nd 3rd						

* : Default

Note : Please make photo copies of this sheet if necessary.

Port Assignment

VM : Voice Mail Service
 AA : Automated Attendant Service
 IS : Interview Service
 CS : Custom Service

See pages 4-37 – 4-39.

System Administration Top Menu → 1 → 3 → 1 ~ 4 → 1 ~ 2

Port No.	Mode	Company Greeting No. (1-32)	Incoming Call Service (VM/AA*/IS/CS)	Incoming Call Service Prompt (System/User1*/User2/ Selective)	Prompt for Rotary Callers (System*/User1/ User2)	Delayed Answer Time (0*-15 sec)
1	Day					
	Night					
2	Day					
	Night					
3	Day					
	Night					
4	Day					
	Night					

* : Default

Department Dialing

See pages 4-40 – 4-41.

System Administration Top Menu → 1 → 4 → 1 → 1

Department Dialing No.	Extension No.	Remarks (Department name, etc.)
1		
2		
3		
4		
5		
6		
7		
8		
9		

Operator's Parameters

Day Mode – Operator 1

See pages 4-41 – 4-44.

System Administration Top Menu → 1 → 4 → 1 → 2 → 1 → 1

Item	Value to Select	Value
Operator Service	1. Disable 2. Enable *	
Operator's Extension No.	2 – 5 digits (* 0)	
Operator's Mailbox No.	2 – 5 digits (* 998)	
Operator No-answer Time	10 – 60 sec (* 30)	
Busy Coverage Mode	1. Hold * 2. No-answer Coverage 3. Call Waiting 4. Disconnect Message	
No-answer Coverage Mode	1. Caller Select * 2. Leave Message 3. Disconnect Message 4. Next Operator	
Message Repeat Cycle	1 – 3 times (* 3)	

* : Default

Day Mode – Operator 2

See pages 4-44 – 4-45.

System Administration Top Menu → 1 → 4 → 1 → 2 → 1 → 2

Item	Value to Select	Value
Operator's Extension No.	2 – 5 digits	
Operator's Mailbox No.	2 – 5 digits	
Busy Coverage Mode	1. Hold * 2. No-answer Coverage 3. Call Waiting 4. Disconnect Message	
No-answer Coverage Mode	1. Caller Select * 2. Leave Message 3. Disconnect Message 4. Next Operator	

* : Default

Operator's Parameters

Day Mode – Operator 3

See pages 4-46 – 4-47.

System Administration Top Menu → 1 → 4 → 1 → 2 → 1 → 3

Item	Value to Select	Value
Operator's Extension No.	2 – 5 digits	
Operator's Mailbox No.	2 – 5 digits	
Busy Coverage Mode	1. Hold * 2. No-answer Coverage 3. Call Waiting 4. Disconnect Message	
No-answer Coverage Mode	1. Caller Select * 2. Leave Message 3. Disconnect Message	

* : Default

Night Mode – Operator 1

See pages 4-41 – 4-44.

System Administration Top Menu → 1 → 4 → 1 → 2 → 2 → 1

Item	Value to Select	Value
Operator Service	1. Disable 2. Enable *	
Operator's Extension No.	2 – 5 digits (* 0)	
Operator's Mailbox No.	2 – 5 digits (* 998)	
Operator No-answer Time	10 – 60 sec (* 30)	
Busy Coverage Mode	1. Hold * 2. No-answer Coverage 3. Call Waiting 4. Disconnect Message	
No-answer Coverage Mode	1. Caller Select * 2. Leave Message 3. Disconnect Message 4. Next Operator	
Message Repeat Cycle	1 – 3 times (* 3)	

* : Default

Operator's Parameters

Night Mode – Operator 2

See pages 4-44 – 4-45.

System Administration Top Menu → 1 → 4 → 1 → 2 → 2 → 2

Item	Value to Select	Value
Operator's Extension No.	2 – 5 digits	
Operator's Mailbox No.	2 – 5 digits	
Busy Coverage Mode	1. Hold * 2. No-answer Coverage 3. Call Waiting 4. Disconnect Message	
No-answer Coverage Mode	1. Caller Select * 2. Leave Message 3. Disconnect Message 4. Next Operator	

* : Default

Night Mode – Operator 3

See pages 4-46 – 4-47.

System Administration Top Menu → 1 → 4 → 1 → 2 → 2 → 3

Item	Value to Select	Value
Operator's Extension No.	2 – 5 digits	
Operator's Mailbox No.	2 – 5 digits	
Busy Coverage Mode	1. Hold * 2. No-answer Coverage 3. Call Waiting 4. Disconnect Message	
No-answer Coverage Mode	1. Caller Select * 2. Leave Message 3. Disconnect Message	

* : Default

Alternate Extension Assignment

See pages 4-48 – 4-49.

System Administration Top Menu → 1 → 4 → 1 → 3 → 1

Mailbox No.							

Custom Service

See pages 4-50 – 4-52.

System Administration Top Menu → 1 → 4 → 2 → Custom Service No.

Custom No.	Description	Prompt Mode	Menu Repeat Cycle	Call Transfer Anytime	Wait for Second Digit	No DTMF Input Operation	Keypad Assignment
1-100	Up to 32 alphanumeric characters	System * User 1 User 2	1- 3 times (* 3)	Extn. * Mbx No	1-5 sec (* 1)	a: Transfer to Mailbox b: Transfer to Extension c: Operator * d: Exit e: Previous Menu f: Custom Service	a: Transfer to Mailbox b: Transfer to Extension c: Operator d: Exit e: Previous Menu f: Custom Service g: Voice Mail Service h: Call Transfer Service i: Subscriber Service j: Department Dialing k: Dial by Name l: Repeat Menu m: Main Menu n: Fax Transfer
							1: 2: 3: 4: 5: 6: 7: 8: 9: *: d 0: c #:
							1: 2: 3: 4: 5: 6: 7: 8: 9: *: d 0: c #:
							1: 2: 3: 4: 5: 6: 7: 8: 9: *: d 0: c #:
							1: 2: 3: 4: 5: 6: 7: 8: 9: *: d 0: c #:
							1: 2: 3: 4: 5: 6: 7: 8: 9: *: d 0: c #:
							1: 2: 3: 4: 5: 6: 7: 8: 9: *: d 0: c #:
							1: 2: 3: 4: 5: 6: 7: 8: 9: *: d 0: c #:

* : Default

Note : Please make photo copies of this sheet if necessary.

Mailbox Group

See pages 4-53 – 4-55.

System Administration Top Menu → 1 → 5 → 1 → 1 → 1 → Group List No.

Group No.	Group Name Up to 16 characters	Mailbox No.									

Note : Please make photo copies of this sheet if necessary.

Extension Group

See pages 4-56 – 4-57.

System Administration Top Menu → 1 → 5 → 1 → 2 → 1 → Group List No.

Group No.	Group Name Up to 16 characters	Extension No.									

Note : Please make photo copies of this sheet if necessary.

Day Service

See page 4-58.

System Administration Top Menu → 1 → 5 → 2

MON	Day service start time	
	Day service end time	
TUE	Day service start time	
	Day service end time	
WED	Day service start time	
	Day service end time	
THU	Day service start time	
	Day service end time	
FRI	Day service start time	
	Day service end time	
SAT	Day service start time	
	Day service end time	
SUN	Day service start time	
	Day service end time	

Note : Set as hh:mm, AM:PM.

The Default is 9:00, AM for Start time and 5:00, PM for End time.

Holiday Setting

See pages 4-58 – 4-61.

System Administration Top Menu → 1 → 5 → 3 → 1 → Holiday No.

No.	Name of Holiday	Date (MM/DD)	Retain Holiday (Y/N*)	Service (VM/AA*/IS/ CS)	Company Greeting No. (1-32)	Port Affected (1*.2*.3*.4*)
1						
2						
3						
4						
5						
6						
7						
8						
9						
10						
11						
12						
13						
14						
15						
16						
17						
18						
19						
20						

* : Default

Daylight Saving Time

See page 4-61.

System Administration Top Menu → 1 → 5 → 4

Item	Date
Start Date (1 hour forward) (MM/DD)	
End Date (1 hour back) (MM/DD)	

Prompt Setting

See pages 4-62 – 4-63.

System Administration Top Menu → 1 → 5 → 5

Item	Value to Select	Value
System Prompt Selection Number	1-9	
User 1 Prompt Selection Number	1-9	
User 2 Prompt Selection Number	1-9	
Position of "AM/PM" in Time Stamp	Before/After*/None	

* : Default

Extension Numbering Plan

See page 4-64.

System Administration Top Menu → 1 → 5 → 6 → 1

Item	Default	Value	Selection
Numbering Plan 1	2XX		2 - 5 digits (X: Don't care)
Numbering Plan 2	3XX		
Numbering Plan 3	—		
Numbering Plan 4	—		
Numbering Plan 5	—		
Numbering Plan 6	—		
Numbering Plan 7	—		
Numbering Plan 8	—		
Numbering Plan 9	—		
Numbering Plan 10	—		
Numbering Plan 11	—		
Numbering Plan 12	—		
Numbering Plan 13	—		
Numbering Plan 14	—		
Numbering Plan 15	—		
Numbering Plan 16	—		

Dialing Parameters

See pages 4-65 – 4-66.

System Administration Top Menu → 1 → 5 → 6 → 2

Item	Default	Value	Selection
Number of Digits to Access Outside Line	1		0 – 8 digits
Call Transfer No-answer Time	20		10 – 60 sec
Outgoing Call No-answer Time	30		10 – 90 sec
Pause Time	2		1 – 9 sec
Outgoing Call Setup Sequence	T		Up to 12 digits (F: Hook Flash) (R: Ring Back Tone Detection) (S: Silence Detection) (T: Dial Tone Detection) (W: Wait for 1 second) (1-9, 0, *, #: Dial Codes)

Message Waiting Notification Parameters

See pages 4-66 – 4-68.

System Administration Top Menu → 1 → 5 → 6 → 3

Item	Default	Value	Selection
Outgoing Call Ports	1,2,3,4		1,2,3,4 (Port number)
Message Waiting Lamp Ports	1,2,3,4		1,2,3,4 (Port number)
Message Waiting Lamp for Every Message	No		Yes/No
Max. Digits for Callback No.	20		1 – 48 digits
Callback No. Entry Interdigit Time-Out	5		1 – 10 sec
System Callback No.	—		Up to 32 digits

External Message Delivery Parameters

See pages 4-68 – 4-69.

System Administration Top Menu → 1 → 5 → 6 → 4

Item	Default	Value	Selection
Retry Times	3		0 – 4 times
Busy Delay	3		2 – 60 min.
No-answer Delay	60		2 – 120 min.
Outgoing Call Ports	1,2,3,4		1,2,3,4 (Port number)
Message Length	3		1 – 6 min.
Max. Messages for Mailboxes	3		1 – 100 messages
System External Message Delivery Duration Time	3		1 – 9 min.
Company's Telephone No.	—		Up to 32 digits

Call Hold

See page 4-70.

System Administration Top Menu → 1 → 5 → 6 → 5

Item	Default	Value	Selection
Call Hold Mode	Enable		Enable/Disable
Call Queuing Announcement Mode	Enable		Enable/Disable
Call Retrieval Announcement Timing	2		1 - 30 sec
Redialing Cancel Timing	30		15:30:45:60 sec

Rotary Telephone Service

See page 4-71.

System Administration Top Menu → 1 → 5 → 6 → 6

Item	Default	Value	Selection
Rotary Telephone Call Coverage Day Mode	G.D.M.		G.D.M./OPERATOR EXTENSION
Rotary Telephone Call Coverage Night Mode	G.D.M.		

Intercom Paging Parameter

See pages 4-72 – 4-73.

System Administration Top Menu → 1 → 5 → 6 → 7

Item	Default	Value	Selection
Intercom Paging Sequence	—		Up to 12 digits
Release for Intercom Paging	—		(D: Disconnecting) (F: Hook Flash) (R: Ring Back Tone Detection) (S: Silence Detection) (T: Dial Tone Detection) (W: Wait for 1 second) (X: Pager Dialing) (A: Answer) (1-9, 0, *, #: Dial Codes)
No-answer Time for Intercom Paging	5		1 – 30 sec
Announcement Repeat Cycle	1		1 – 3 times
Intercom Paging Retry	2		1 – 10 times
Paging Code for Group 1	—		Up to 12 (0-9) numeric characters
Paging Code for Group 2	—		
Paging Code for Group 3	—		
Paging Code for Group 4	—		
Paging Code for Group 5	—		
Paging Code for Group 6	—		
Paging Code for Group 7	—		
Paging Code for Group 8	—		

Fax Management

See pages 4-73 – 4-75.

System Administration Top Menu → 1 → 5 → 6 → 8

Item	Default	Value	Selection
Automatic Transfer of Incoming Fax Call	Disable		Enable/Disable
Main Fax Extension No.	—		2 – 5 digits (Extension No.)
Alternate Fax Extension No.	—		2 – 5 digits (Extension No.)
Fax No-answer Time	10		5 – 60 sec
Fax Manager Mailbox No.	—		2 – 5 digits (Mailbox No.)
Fax No-answer Coverage Mode	No		Extn./Mbx/No
Fax Notification Mode	No		

Disconnect Parameter

See page 4-75.

System Administration Top Menu → 1 → 5 → 6 → 9

Item	Default	Value	Selection
Maximum Silence Time	10		5 - 60 sec

RS-232C Parameters

See pages 4-76 – 4-77.

System Administration Top Menu → 1 → 6 → 1

Item	Default	Value	Selection
Baud Rate	9600		300/600/1200/2400/4800/ 9600/19200 b.p.s
Word Bit Length	8		7/8 bits
Parity	None		None/Odd/Even
Stop Bit Length	1		1/2 bits

Port Setting

See pages 4-77 – 4-78.

System Administration Top Menu → 1 → 6 → 2 → Port No.

Port No.	Flash Time	CPC Signal	Disconnect Time	Dial Mode
1 – 4	1 : 100 msec *	1 : None 2 : 6.5 msec * 3 : 150 msec 4 : 300 msec 5 : 450 msec 6 : 600 msec	1 : 1 sec 2 : 2 sec* 3 : 3 sec : : 8 : 8 sec	1 : DTMF * 2 : Pulse 10 pps
Port 1				
Port 2				
Port 3				
Port 4				

* : Default

Note: Port 3 and Port 4 are applicable only to TVS100.

Dialing Parameters

See pages 4-79 – 4-82.

System Administration Top Menu → 1 → 6 → 3 → 1

Item	Default	Value	Selection
PBX Type	Other		Other Manufactures/ KX-T Series: T308 T616 T1232 T96 T336 TD816 TD1232
Integration Mode	None		None/Inband/D-PITS
Operator Transfer Sequence	FX		Up to 12 digits (D: Disconnecting) (R: Ring Back Tone Detection) (T: Dial Tone) (X: Extension Dialing) (F: Hook Flash) (S: Silence Detection) (W: Wait for 1 second) (A: Answer) 0-9, *, #: Dial Codes
Extension Transfer Sequence	FX		
Alternate Extension Transfer Sequence	FX		
Reconnect Sequence on Busy	FWW		
Reconnect Sequence on No-answer	FWW		
Reconnect Sequence on Refuse Call	FWW		
Light-On Sequence for MWL	—		
Light-Off Sequence for MWL	—		
Call Waiting Sequence	—		
Release Sequence for Call Waiting	—		

Inband Signaling Parameters

See pages 4-83 – 4-85.

System Administration Top Menu → 1 → 6 → 3 → 2

Item	Default	Value	Selection
Ringback	1		Up to 8 alphanumeric characters (0-9, *, #, A-D)
Busy	2		
Reorder	3		
DND	4		
Answer	5		
Forward to VM Ringing	6		
Forward to VM Busy	7		
Forward to Other Extension	8		
Confirmation	9		
Disconnect	#9		

Digit Translation Table Parameters

See page 4-85.

System Administration Top Menu → 1 → 6 → 3 → 3 → 1

Inter-Digit Timeout

Item	Default	Value	Selection
Inter-digit Timeout	1		1 - 4 sec

See page 4-86.

System Administration Top Menu → 1 → 6 → 3 → 3 → 2

Digit Translation Table

Item	Default	Input-digit	Output-digit	Selection
Table 1	—			Up to 8 digits (0-9, *, #, A-D)
Table 2	—			
Table 3	—			
Table 4	—			
Table 5	—			
Table 6	—			
Table 7	—			
Table 8	—			

Worksheets for System Manager

Contents

Setting System Manager's Password	W-2-2
Mailbox Settings	W-2-3
Class of Service Setting	W-2-4

Setting System Manager's Password

See page 5-16.

System Manager Top Menu → [3]

	Password
System Manager's Password	

Mailbox Settings

IMBox : Interview Mailbox

AITrf : All Calls Transfer to Mailbox

See pages 5-4 – 5-5.

System Manager Top Menu → [6] → [1]

Mbx No.	Ext. No.	Mailbox Owner's Name		COS 1-64 (* 1)	IMBox	AITrf 1: Yes 2: No*
		For recording	Initial 3 or 4 letters			

* : Default

Note : Please make photo copies of this sheet if necessary.

Class of Service Setting

See pages 5-9 – 5-10.
System Manager Top Menu → [6] → [2]

COS	Message Waiting Notification			External Message Delivery		Auto Forwarding				
	Y/N*	Beeper Callback No. Entry Mode Select Without Before After Disable	MWL for Unreceived Message Y/N	Device Notification for Unreceived Message Y/N	Y/N*	Prompt Mode System User 1 User 2 Selective	Y/N*	Mailbox No.	Delay Time	Forwarding Mode
									00:05~ 99:59	Copy Move

* : Default
Note : Please make photo copies of this sheet if necessary.

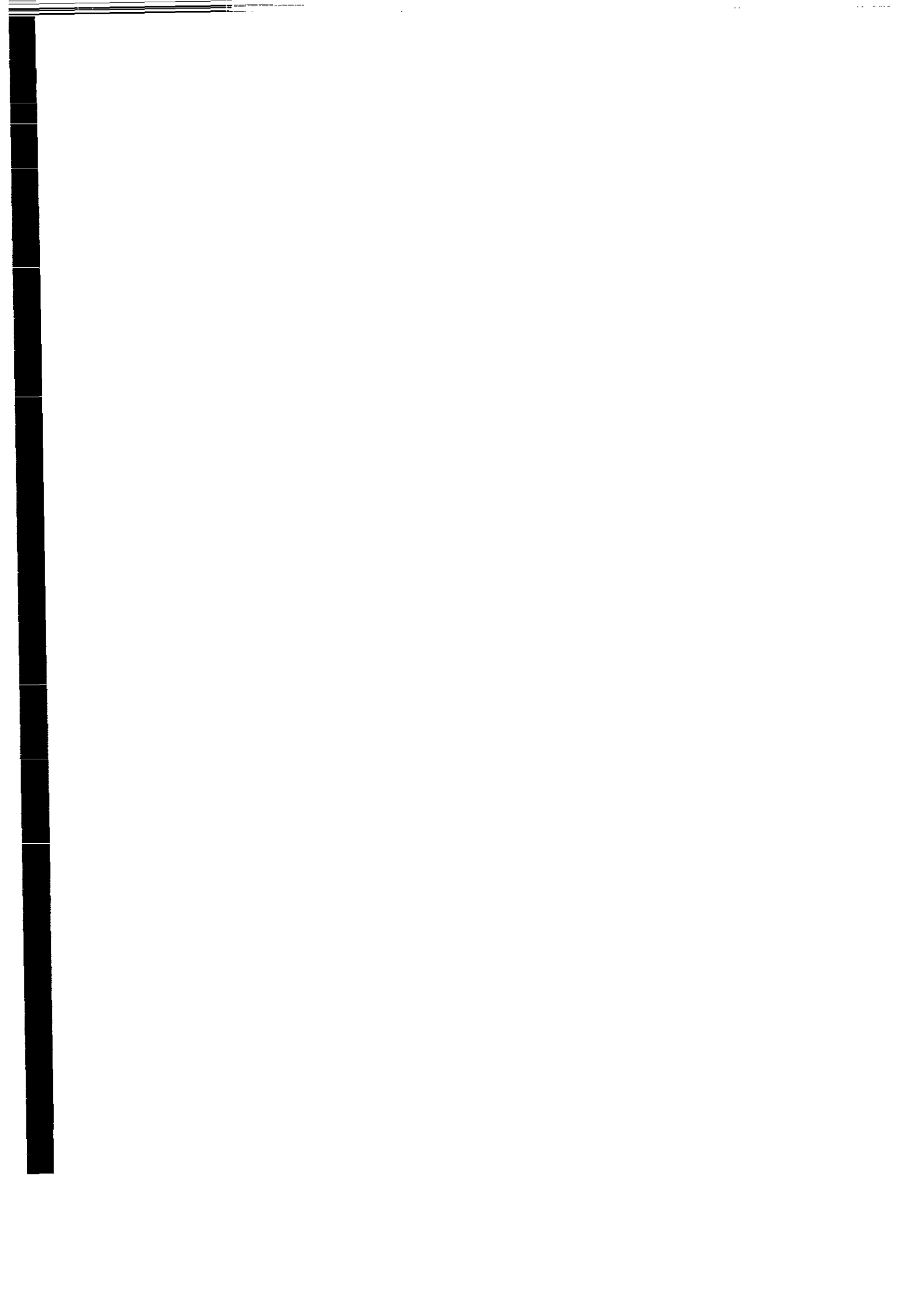

Worksheets for Message Manager

Contents

Message Manager's Password	W-3-2
Mailbox Owner's Address.....	W-3-3
Company Greetings	W-3-4
Company Name	W-3-5
Department Dialing	W-3-6
Custom Service Menus	W-3-7
Mailbox Distribution Group Name	W-3-8
Modifying Voice Prompt	W-3-9
Selection Menu	W-3-10

Message Manager's Password

See page 6-10.

Message Manager Top Menu → [3]

Message Manager's Password	
-------------------------------	--

Mailbox Owner's Address

See page 6-6.

Use this sheet when you transfer messages in the
General Delivery Mailbox.

Mailbox No.	Mailbox Owner's Name

Note : Please make photo copies of this sheet if necessary.

Company Greetings

See page 6-12.

Message Manager Top Menu → [5] → [1]

Company Greeting No.:	
Message:	

Company Greeting No.:	
Message:	

Company Greeting No.:	
Message:	

Note : Please make photo copies of this sheet if necessary.

Company Name

See pages 6-12 – 6-13.

Message Manager Top Menu → [5] → [2]

Company Name: <hr/> <hr/> <hr/> <hr/> <hr/> <hr/>
--

Department Dialing

See pages 6-13 – 6-14.

Message Manager Top Menu → [5] → [3]

Dialing Menu:

Departmental Dialing No.	Extension No.	Remarks (Department name, etc.)
1		
2		
3		
4		
5		
6		
7		
8		
9		

Custom Service Menus

See page 6-14.

Message Manager Top Menu → [5] → [4]

Custom Service No.:			
Menu Message:			

Keypad Assignment			
1:	2:	3:	4:
5:	6:	7:	8:
9:	*: Exit	0: Operator	#:

Custom Service No.:			
Menu Message:			

Keypad Assignment			
1:	2:	3:	4:
5:	6:	7:	8:
9:	*: Exit	0: Operator	#:

Note : Please make photo copies of this sheet if necessary.

Mailbox Distribution Group Name

See page 6-15.

Message Manager Top Menu → [5] → [5]

Group No.	Voice label Up to 16 characters

Note : Please make photo copies of this sheet if necessary.

Modifying Voice Prompt

See pages 6-15 – 6-16.

Message Manager Top Menu → [5] → [6]

Prompt No.:	
Prompt:	<hr/> <hr/> <hr/> <hr/> <hr/>

Prompt No.:	
Prompt:	<hr/> <hr/> <hr/> <hr/> <hr/>

Prompt No.:	
Prompt:	<hr/> <hr/> <hr/> <hr/> <hr/>

Note : Please make photo copies of this sheet if necessary.

Selection Menu

See pages 6-16 – 6-17.

Message Manager Top Menu → [5] → [7]

Selection Menu: _____ _____ _____ _____ _____
--

Prompt	Language	Key Assignment
System	English	
User 1		
User 2		



208

Panasonic Business Systems U.K.

Panasonic House, Willoughby Road, Bracknell,
Berkshire RG12 4FP

Printed in Japan

PSQX1101ZA KK0496CK0