

Welcome

Internal Antenna

Earpiece

Left Soft Key

Perform functions identified by left display prompt.

Right Soft Key

Perform functions identified by right display prompt.

Menu Key

Open a menu when you see  in the display.

Send/Answer Key

Make and answer calls; press in idle to see recent dialed calls.

Power/End Key

Press & hold to power phone on & off.
Press & release to end phone calls, exit menu system.

Navigation Keys

Scroll through lists, set volume.

USB Connector Port

Insert data cable.

Microphone

Headset Connector Port

Power Connector Port

Insert charger.

Your C350 phone lets you change covers and keypads (see page 23). Your phone may not appear exactly as the phone image above.

Note that all key locations, sequences and functions remain the same with any of the various covers.

www.hellomoto.com

MOTOROLA and the Stylised M Logo are registered in the US Patent & Trademark Office. All other product or service names are the property of their respective owners.

© Motorola, Inc. 2002.

Software Copyright Notice

The Motorola products described in this manual may include copyrighted Motorola and third party software stored in semiconductor memories or other media. Laws in the United States and other countries preserve for Motorola and third party software providers certain exclusive rights for copyrighted software, such as the exclusive rights to distribute or reproduce the copyrighted software. Accordingly, any copyrighted software contained in the Motorola products may not be modified, reverse-engineered, distributed, or reproduced in any manner to the extent allowed by law. Furthermore, the purchase of the Motorola products shall not be deemed to grant either directly or by implication, estoppel, or otherwise, any licence under the copyrights, patents, or patent applications of Motorola or any third party software provider, except for the normal, non-exclusive, royalty-free licence to use that arises by operation of law in the sale of a product.

While Products specifications and features may be subject to change without notice, we are making every possible effort to ensure that user manuals are updated on a regular basis to reflect product functionality revisions. However, in the unlikely event that your manual version does not fully reflect the core functionality of your product, please let us know. You may also be able to access up-to-date versions of our manuals in the consumer section of our Motorola web site, at www.hellomoto.com.

Menu Map

Main Menu

- **Voice Dial**
- **Recent Calls**
 - Received Calls
 - Dialed Calls
 - Notepad
 - Call Times
 - Call Cost
 - Data Times
 - Data Volumes
- **Chat ***
- **Media Centre**
 - Theme
 - My Tones
 - MotoMixer
 - Picture Viewer
- **Ring Styles**
 - Alert
 - *Alert* Detail
 - My Tones
- **WebAccess**
 - Web Browser
 - Bookmarks
 - Stored Pages
 - History
 - Go to URL
 - Browser Setup
- **Games**
- **Browser ***
- **Office Tools**
 - Datebook
 - Calculator

- **More**
(go to following menu items)
- **Settings**
(see next page)
- **Phonebook**
- **Web Sessions ***
- **MyMenu**
- **Messages ***
 - Create Message
 - Voicemail
 - Text Msgs
 - Browser Msgs
 - Info Services
 - Quick Notes
 - Outbox
 - Drafts
- **SIM Applications ***
- **Fixed Dial ***
- **Service Dial ***
- **Quick Dial ***

*Note: Select **More** when it appears in the menu to see additional menu items.*

*Note: This is the standard phone menu layout. Your service provider may change the layout, or feature names. For example, some features listed in the generic Main Menu shown on this page may appear under **More** in your phone and vice versa. To change the layout yourself, see page 91. Not all features may be available for all users.*

* Optional network, SIM card, or subscription-dependent features

Settings Menu

• Call Divert *

- Voice Calls
- Fax Calls
- Data Calls
- Cancel All
- Divert Status

• Phone Status

- My Tel. Numbers *
- Credit Info/Available *
- Active Line *
- Battery Meter
- Other Information

• In-Call Setup

- In-Call Timer
- Call Cost Setup *
- My Caller ID
- Talk and Fax *
- Answer Options
- Call Waiting *

• Security

- Phone Lock
- Lock Keypad
- Lock Application
- Fixed Dial
- Call Barring *
- SIM PIN
- New Passwords

• Other Settings











- Personalise
 - Main Menu
 - Keys
 - Colour Style
 - Greeting *
 - Wallpaper
 - Screen Saver
 - Quick Dial *
- Initial Setup
 - Time and Date
 - 1-Touch Dial
 - Backlight
 - Zoom
 - Scroll
 - Animation
 - Language
 - Battery Save
 - Contrast
 - DTMF
 - Master Reset
 - Master Clear
- Network
- Car Settings
- Headset

Note: Not all features may be available for all users.

* Optional network, SIM card, or subscription-dependent features

Shortcuts

Following are some useful shortcuts. To create your own MyMenu shortcuts, see page 93.

Task	Shortcut
Change display zoom	Press  , then press and hold 
Lock/unlock keypad	Press  
Change ringer alert	Press  left (at lowest volume setting) to switch to vibrate alert, then silent alert. Press right to reset ring alert.
Display my phone number	Press   in idle (number must be stored on SIM card)
Go to dialled calls list	Press  in idle
Exit menu system	Press 
Open phonebook	Press  down in idle
Create phonebook entry	Press  up in idle

Contents

Menu Map	3
Shortcuts	5
Safety and General Information	10
Getting Started	17
What's in the Box?	17
About This Guide	17
Installing the Battery	18
Charging the Battery	19
Battery Use	20
Changing Your SIM Card	21
Changing Your Phone's Cover	23
Resetting Your Phone	26
Turning Your Phone On	26
Adjusting the Volume	27
Making and Answering Calls	27
Changing the Call Alert	29
Viewing Your Phone Number	29
Using Your Phone	30
Using the Display	30
Using the Menu	33
Entering Text	36
Changing the Zoom Setting	45
Setting Up Your Phone	45
Calling Features	52
Displaying Your Phone Number	52
Redialling a Number	52
Using Caller ID	53

Terminating an Incoming Call	53
Dialling an Emergency Number	54
Dialling International Numbers	54
Inserting Special Characters into Dialling Sequences	54
Viewing the Received Calls or Dialed Calls List	55
Returning an Unanswered Call	58
Entering Numbers in the Notepad	58
Attaching a Number	59
Using Voicemail	59
Speed Dialling	61
One-Touch Dialling	61
Quick Dialling	62
Using Call Waiting	62
Diverting a Call	63
Linking Calls	65
Transferring a Call	66
Barring a Call	67
Putting a Call on Hold	68
Messages	69
Setting Up the Text Message Inbox	69
Sending Messages, Pictures, and Ring Tones	71
Viewing Message Status	72
Receiving a Text Message	73
Reading, Locking, or Deleting a Text Message	73
Using Chat	75
Phonebook	79
Viewing Entry Details	79
Storing a Phonebook Entry	80
Recording a Voice Name For a Phonebook Entry	84
Dialling a Phonebook Entry	85
Editing a Phonebook Entry	85

Sorting Phonebook Entries	86
Copying Phonebook Entries	87
Checking Phonebook Capacity	90
Customising Your Phone Settings	91
Reordering the Main Menu	91
Reordering the Message Centre Menu	91
Redefining Soft Keys	92
Selecting a Different Language	93
Activating Ringer IDs	93
Using Shortcuts	93
Setting a Wallpaper Image	95
Setting a Screen Saver	95
Getting More Out of Your Phone	96
Dialling Options	96
Managing Your Calls	97
Monitoring Phone Use	98
Network Features	101
Security	106
Locking and Unlocking Your Phone	106
Changing Your Unlock Code	107
Locking and Unlocking the Keypad	109
Protecting the SIM Card	109
Line Security	111
Personal Organiser Features	112
Datebook	112
Alarm Reminders	117
Calculator	117
News and Entertainment	120
Mobile Internet	120
Phone Themes	122

Picture Viewer	124
Games	125
MotoMixer Sound Editor	129
Creating Alert Tones	132
SIM Applications	137
Troubleshooting	138
Warranty Information	146
Specific Absorption Rate Data	151
Index	153

Safety and General Information

IMPORTANT INFORMATION ON SAFE AND EFFICIENT OPERATION

READ THIS INFORMATION BEFORE USING YOUR PERSONAL COMMUNICATOR

The information provided in this document supersedes the general safety information contained in user guides published prior to this date. For information regarding radio use in a hazardous atmosphere please refer to the Factory Mutual (FM) Approval Manual Supplement or Instruction Card, which is included with radio models that offer this capability.

RF Operational Characteristics

Your Personal Communicator contains a transmitter and a receiver. When it is ON, it receives and transmits radio frequency (RF) energy. The Personal Communicator operates in the frequency range of 900 MHz to 1990 MHz and employs digital modulation techniques.

When you communicate with your Personal Communicator, the system handling your call controls the power level at which your personal communicator transmits. The output power level typically may vary over a range from 0.063 watts to 1.58 watts.

Exposure To Radio Frequency Energy

Your Motorola Personal Communicator is designed to comply with the following national and international standards and guidelines regarding exposure of human beings to radio frequency electromagnetic energy:

- United States Federal Communications Commission, Code of Federal Regulations; 47 CFR part 2 sub-part J

- American National Standards Institute (ANSI) / Institute of Electrical and Electronic Engineers (IEEE) C95. 1-1992
- Institute of Electrical and Electronic Engineers (IEEE) C95. 1-1999 Edition
- National Council on Radiation Protection and Measurements (NCRP) of the United States, Report 86, 1986
- International Commission on Non-Ionizing Radiation Protection (ICNIRP) 1998
- National Radiological Protection Board of the United Kingdom 1995
- Ministry of Health (Canada) Safety Code 6. Limits of Human Exposure to Radiofrequency Electromagnetic Fields in the Frequency Range from 3 kHz to 300 GHz, 1999
- Australian Communications Authority Radiocommunications (Electromagnetic Radiation - Human Exposure) Standard 1999 (applicable to wireless phones only)

To assure optimal performance and make sure human exposure to radio frequency electromagnetic energy is within the guidelines set forth in the above standards, always adhere to the following procedures:

Portable Personal Communicator Operation and EME Exposure

Antenna Care

Use only the supplied or an approved replacement antenna.

Unauthorized antennas, modifications, or attachments could damage the Personal Communicator and may violate FCC and/or other applicable regulations.

DO NOT hold the antenna when the Personal Communicator is “IN USE”. Holding the antenna affects call quality and may cause

the Personal Communicator to operate at a higher power level than needed.

Phone Operation

The Personal Communicator is designed to be used with a headset for talking and listening. The Personal Communicator can also be placed inside the holster, then the holster can be clipped onto your belt, pocket, handbag, or other apparel and used with the headset.

Body-worn Operation

To maintain compliance with FCC RF exposure guidelines, if you wear the Personal Communicator on your body when transmitting, always place the Personal Communicator in a **Motorola supplied or approved clip, holder, holster, case, or body harness**. Use of non-Motorola-approved accessories may exceed FCC RF exposure guidelines. **If you do not use a body-worn accessory, ensure the antenna is at least one inch (2.5 cm) from your body when transmitting.**

Approved Accessories

For a list of approved Motorola accessories, look in the accessory section of this manual.

Electromagnetic Interference/Compatibility

Nearly every electronic device is susceptible to electromagnetic interference (EMI) if inadequately shielded, designed or otherwise configured for electromagnetic compatibility.

Facilities

To avoid electromagnetic interference and/or compatibility conflicts, turn off your Personal Communicator in any facility where posted notices instruct you to do so. Hospitals or health care facilities may be using equipment that is sensitive to external RF energy.

Aircraft

When instructed to do so, turn off your Personal Communicator when on board an aircraft. Any use of a Personal Communicator must be in accordance with applicable regulations per airline crew instructions.

Medical Devices

Pacemakers

The Health Industry Manufacturers Association recommends that a minimum separation of 6 inches (15 centimetres) be maintained between a handheld wireless phone and a pacemaker. These recommendations are consistent with the independent research by, and recommendations of, Wireless Technology Research.

Persons with pacemakers should:

- ALWAYS keep the Personal Communicator more than six inches (15 centimetres) from their pacemaker when the Personal Communicator is turned ON.
- not carry the Personal Communicator in the breast pocket.
- use the ear opposite the pacemaker to minimise the potential for interference.
- turn the Personal Communicator OFF immediately if you have any reason to suspect that interference is taking place.

Hearing Aids

Some digital wireless phones may interfere with some hearing aids. In the event of such interference, you may want to consult your hearing aid manufacturer to discuss alternatives.

Other Medical Devices

If you use any other personal medical device, consult the manufacturer of your device to determine if it is adequately

shielded from RF energy. Your doctor may be able to assist you in obtaining this information.

Safety and General

Use in Vehicles

Check the laws and regulations on the use of phones in your vehicle. You are advised to always obey them.

When using your Personal Communicator in a vehicle, please:

- Use hands-free operation, if available.
- Pull off the road and park before making or answering a call.

Operational Warnings

For Vehicles with an Air Bag

Do not place the Personal Communicator in the area over an air bag or in the air bag deployment area. Air bags inflate with great force. If the Personal Communicator is placed in the air bag deployment area and the air bag inflates, the Personal Communicator may be propelled with great force and cause serious injury to occupants of the vehicle.

Potentially Explosive Atmospheres

Turn off your Personal Communicator prior to entering any area with a potentially explosive atmosphere, unless it is especially qualified for use in such areas as “Intrinsically Safe” (for example, Factory Mutual, CSA, or UL Approved). Do not remove, install, or charge batteries in such areas. Sparks in a potentially explosive atmosphere can cause an explosion or fire resulting in bodily injury or even death.

The areas with potentially explosive atmospheres referred to above include fuelling areas such as below decks on boats, fuel or

chemical transfer or storage facilities, areas where the air contains chemicals or particles, such as grain, dust or metal powders, and any other area where you would normally be advised to turn off your vehicle engine. Areas with potentially explosive atmospheres are often but not always posted.

Blasting Caps and Areas

To avoid possible interference with blasting operations, turn off your Personal Communicator when you are near electrical blasting caps, in a blasting area, or in areas posted: "Turn off two-way radio". Obey all signs and instructions.

Operational Cautions

Antennas

Do not use the Personal Communicator if it has a damaged antenna. If a damaged antenna comes into contact with your skin, a minor burn can result.

Batteries

All batteries can cause property damage and/or bodily injury such as burns if a conductive material such as jewellery, keys, or beaded chains touch exposed terminals. The conductive material may complete an electrical circuit (short circuit) and become quite hot. Exercise care in handling any charged battery, particularly when placing it inside a pocket, bag, or other container with metal objects.

European Union Directives Conformance Statement



Hereby, Motorola declares that this product is in compliance with

- The essential requirements and other relevant provisions of Directive 1999/5/EC
- All other relevant EU Directives

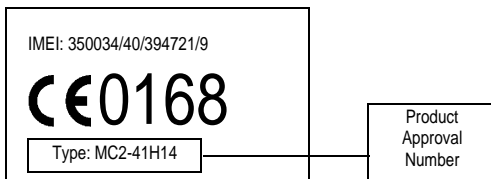

The above gives an example of a typical Product Approval Number.

You can view your product's Declaration of Conformity (DoC) to Directive 1999/5/EC (the R&TTE Directive) at www.motorola.com/rtte - to find your DoC, enter the Product Approval Number from your product's label in the "Search" bar on the Web site.

Getting Started

What's in the Box?

Your digital wireless phone typically comes equipped with a battery and a charger. Other accessory options can customise your phone for maximum performance and portability.

To purchase Motorola Original™ accessories, please contact Motorola as per the enclosed User Information publication.

About This Guide

Optional Features



Features marked with this label are optional network, SIM card, and/or subscription-dependent features. These features may not be offered by all service providers in all geographical areas. Contact your service provider for information about availability.

Optional Accessories



Features marked with this label require the use of an optional Motorola Original™ accessory.

Installing the Battery

You must install and charge the battery to use your phone.



Your phone is designed to be used only with Motorola Original batteries and accessories. We recommend that you store batteries in their protective cases when not in use.

Do This

- 1 Remove the battery from its protective clear plastic case, if necessary.

- 2 Press down on the cover release button at the top of your phone.
- 3 Pull the top of the phone's back cover to release it.

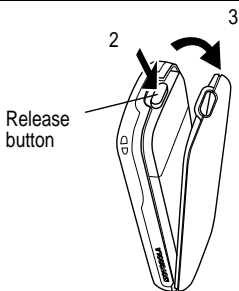

-
- 4 Insert the battery with printed arrows and two tabs at the top of the battery compartment.
 - 5 Push down until the battery is inserted at the bottom.

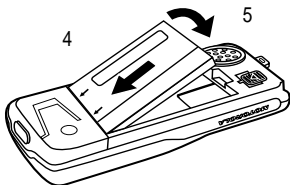

Do This

- 6 Insert the bottom of the back cover.
- 7 Press the top of the back cover down until it hooks over the cover release button.

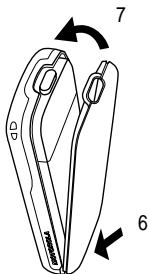

Charging the Battery

New batteries are shipped partially charged. Before you can use your phone, you need to install and charge the battery, as indicated by the following instructions. Some batteries perform best after several full charge/discharge cycles.

Do This

- 1 Plug the travel charger into the middle jack on the bottom of your phone.

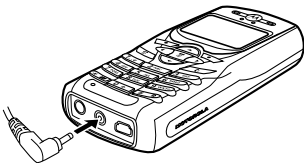

- 2 Plug the other end of the travel charger into the appropriate electrical outlet.
 - 3 When your phone indicates that the battery is fully charged (**Charge Complete**), remove the travel charger.
-
-

Caution: If the battery is fully or heavily discharged, your phone may not display **Charging** for up to one minute after inserting the charger. **Do not** attempt to force the charger further in if you do not see an immediate response.

Note: When you charge the battery, the battery level indicator in the upper right corner of the display shows how much of the charging process is complete. See page 31.

Battery Use

Caution: To prevent injuries or burns, do not allow metal objects to contact or short-circuit the battery terminals.

To maximise your battery's performance:

- Always use Motorola Original™ batteries and battery chargers. The phone warranty does not cover damage caused from using non-Motorola batteries and/or battery chargers.
- New batteries or batteries that have been stored for long periods of time may require a longer initial charge time.
- Maintain the battery at or near room temperature when charging.
- Do not expose batteries to temperatures below -10°C (14°F) or above 45°C (113°F). Always take your phone with you when you leave your vehicle.
- When you do not intend to use a battery for a while, store it uncharged in a cool, dark, dry place, such as a refrigerator.
- Over extended periods of time, batteries gradually wear down and require longer charging times. This is normal. If you charge your battery regularly and notice a decrease in talk time or an increase in charging time, then it is probably time to purchase a new battery.



The rechargeable batteries that power this product must be disposed of properly and may need to be recycled. Refer to your battery's label for battery type. Contact your local recycling centre for proper disposal methods. Never dispose of batteries in a fire because they may explode.

Changing Your SIM Card

Your SIM (Subscriber Identity Module) card contains your phone number, service details, and phonebook/message memory. It must be installed in the base of the phone. If you have problems with your SIM card, contact your service provider.

Caution: Do not bend or scratch your SIM card. Avoid exposing your SIM card to static electricity, water, or dirt.

Note: Since your phone lets you change covers and keypads, it may not appear exactly as the phone pictured. All key locations, sequences, and functions remain the same with any of the various covers.

Do This

- 1 Press down on the cover release button at the top of your phone.
- 2 Pull the top of the phone's back cover to release it.

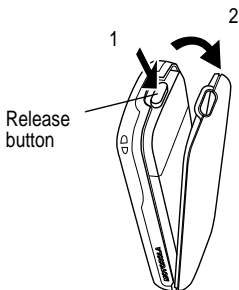

-
- 3 Lift out the battery from the base of the phone.

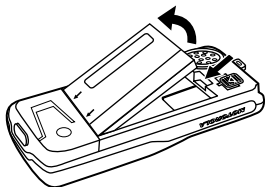

Do This

- Slide the plastic SIM card tab forward to unlock the SIM.
- Lift out the old SIM card, if necessary.

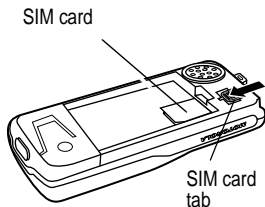

-
- Slide in the new SIM card in the holder with the cut corner on the upper left and the gold plate facing down.

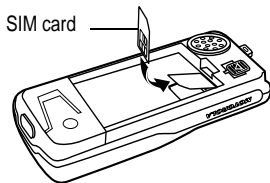

-
- Insert the battery with printed arrows and two tabs at the top of the battery compartment.
 - Push down until the battery is inserted at the bottom.

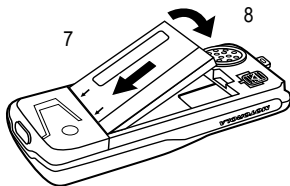

Do This

- 9 Insert the bottom of the back cover.
- 10 Press the top of the back cover down until it hooks over the cover release button.

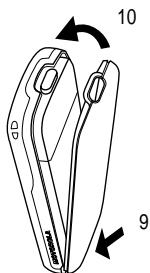

Changing Your Phone's Cover



Always use Motorola Original™ covers. The phone warranty does not cover damage caused from using non-Motorola accessories.

Your phone uses a convertible cover, keypad, and (in some cases) side band that you may replace to completely change its appearance.

Note: *Since your phone lets you change covers and keypads, it may not appear exactly as the phone pictured. All key locations, sequences, and functions remain the same with any of the various covers.*

Remove Cover and Keypad

Do This

- 1 Press down on the cover release button at the top of your phone.
- 2 Pull the top of the phone's back cover to release it.
- 3 If your cover has a removable side band, remove it now.

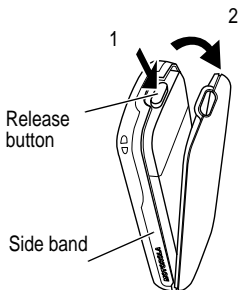

-
- 4 Pull the side tabs away from the phone.
 - 5 Lift up on the lanyard loop to pull the phone out of the front cover.

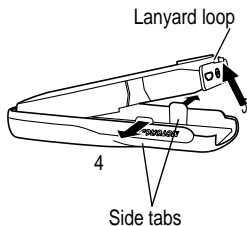

Always use the keypad and side band (if applicable) that matches the new cover.

Install Cover and Keypad

Do This

- 1 If your phone has an end cap, install it before attaching the front cover.
- 2 Slide the top of the phone into the top of the new front cover.

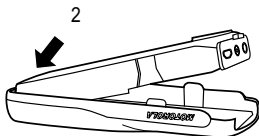

- 3 Press the bottom of the phone into the front cover until the side tabs snap into place.
- 4 If your cover has a removable side band, attach it now.

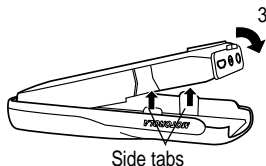

- 5 Insert the bottom of the back cover.
- 6 Press the top of the back cover down until it hooks over the cover release button.

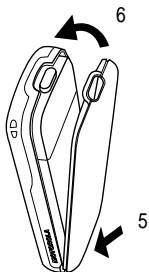

Resetting Your Phone

If your phone becomes frozen on a single display, error message, or power up, reset your phone as follows:

Do This

- 1 Remove your phone's back and front cover as described on page 21.

- 2 Use a small object to press the Reset button on the front of your phone.

Your phone display should be restored.

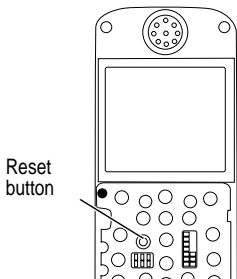

- 3 Replace your phone's cover.

Turning Your Phone On

Do This

- 1 Press and hold  (the End/Power key).

End/
Power
Key

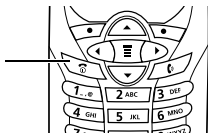

- 2 If necessary, enter your SIM card PIN code and press **OK** () to unlock your SIM card.



Note: If you enter an incorrect PIN code three times in a row, your SIM card is disabled and your phone displays the message **SIM Blocked**. (For more information, see page 109.)

Do This

- 3 If necessary, enter your four-digit unlock code and press **OK** () to unlock your phone.

Note: The unlock code is originally set to 1234. (For more information, see page 106.)



*Note: At startup, you are given the option to personalise your phone. Select **YES** () to set personal phone options, or **NO** () to go to the idle display. For more information, see page 91.*

Adjusting the Volume

You can adjust your phone's earpiece and ring tone volume by pressing  left and right.

When	You Can Adjust
you are in a call	earpiece speaker volume
the display is idle	ring tone volume

Making and Answering Calls

This section summarises the most basic calling features. For more features, see page 52.

Making a Call

There is a built-in antenna in the top of your phone. Do not block the antenna while you are making a call.

To call a number, your phone must:

- be turned on and unlocked
- have a SIM card inserted and unlocked
- have a network connection with adequate signal strength

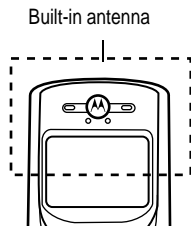



Do This

- 1 Enter the number with the keypad keys (up to 40 digits).

Note: If you make a mistake, press

DELETE  to delete the last digit, or press and hold

DELETE  to clear all digits.

- 2 Press  (send key) to make the call.
-

- 3 Press  (end key) when the call is done.
-
-

Note: You can make an emergency call even when the phone is locked, or when a SIM card is not inserted. See page 54.



Answering a Call

To answer a call, your phone must:

- be turned on and unlocked
- have a SIM card inserted and unlocked
- have a network connection with adequate signal strength



When you receive a call, your phone rings and/or vibrates and displays an incoming call message.

Do This



- 1 Press  or **ANSWER** 
-

- 2 Press  (end key) when the call is done.
-
-

Changing the Call Alert

- Press  left to switch the alert for incoming calls and other events to vibrate, then silent.
- Press  right to reset your phone to ring alert.

Viewing Your Phone Number

To view your phone number from the idle display, press  .

While you are on a call, press  > **My Tel. Numbers**.

Note: Your phone number must be stored on your SIM card to use this feature. If you do not know your phone number, contact your service provider.

Using Your Phone

See page 1 for a diagram of basic phone components.

Using the Display

The top section of the display shows phone status indicators. The following illustration shows some of the common indicators that you may see at the top of the display when using your phone.

Messages, phone numbers, and menu options appear in the middle of the display. Text labels at the bottom corners of the display show the current soft key functions. A  (menu) indicator in the bottom centre of the display indicates that you can open the main menu or a feature sub-menu to see more options. For more information about the soft key and menu key labels, see page 33.

Some of the phone functions described in this guide must be performed from the idle display. The term *idle display* refers to the standard display that you see when your phone is on and ready to use, when you are *not* on a call or using the menu system.

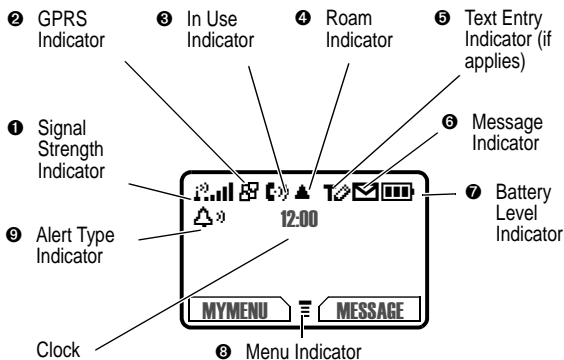

1 Signal Strength Indicator Shows the strength of your phone's connection with the network.

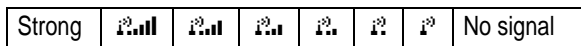

You cannot make or answer calls when the “no signal” indicator is displayed.





2 GPRS Indicator Indicates that your phone is using a high-speed GPRS network connection (). GPRS allows faster data transfer speeds. The indicator does not mean that you are in a call; only that you are registered on the network via a GPRS connection.

Other indicators can include:

 = GPRS PDP context active

 = GPRS packet data available

3 In Use Indicator Indicates when a call is in progress, and when you have a secure () or unsecure () connection.



4 Roam Indicator Appears when your phone uses another network system outside your home network. When you leave your home network area, your phone *roams* or seeks another network. Icons here can also indicate your text entry mode (alpha, numeric, symbol, etc.)

5 Text Entry Indicator Indicates your Text Entry Method whenever you are in a text editor (Tap, iTap, etc.). See page36.



6 Message Indicator Indicates when you have an active Chat session, or when you have a new voice or text message waiting.

7 Battery Level Indicator Shows the amount of charge left in your battery. The more bars visible, the greater the charge.

High     Low

Recharge your battery when you see the **Low Battery** warning message and hear the low battery alert.

8 Menu Indicator Indicates that you can press  to open a menu. See page 33.

9 Alert Type Indicator Shows the current selected alert profile. The default alert setting is loud ring.

 = loud ring

 = soft ring

 = vibrate

 = vibrate and ring

 = silent

Using the Menu

You can access many of your phone's features by using these keys to move through the menu system:

Left Soft Key

Perform functions identified by left display prompt.

Right Soft Key

Perform functions identified by right display prompt.

Menu Key

Enter menu system or open a sub-menu.



Power/End Key

Press & hold to power phone on & off.
Press & release to end phone calls, exit menus.

Navigation Keys

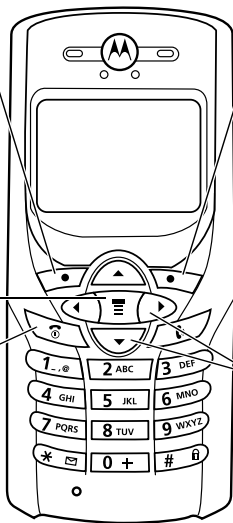
Scroll through menus and lists, set feature values.



From the idle display, press  to enter the main menu. Press  to scroll through menu features in the main menu.

Navigating to a Feature

This guide shows how to navigate to a menu feature as follows:

Find the Feature

 > **Recent Calls**
> **Dialled Calls**

The > symbol means that you should scroll to and select the feature. This example shows that you should press , scroll to and select **Recent Calls**, then scroll to and select **Dialled Calls** to see the dialled calls list.

Selecting a Feature

Some features require you to select an item from a list:

Press **BACK** () to go back to the previous screen.

A sub-menu is available. Press  to open the sub-menu.

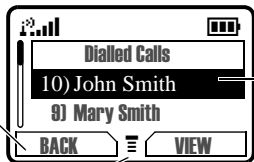

Highlighted item

Press **VIEW** () to view details of the highlighted item.

Select an item by highlighting it using one of these approaches:

- Press  to scroll up or down to the item you want.
- In a numbered list, press a number key to highlight the item.
- In an alphabetised list, press a key multiple times to cycle through the letters on the key and highlight the closest matching list item.

Entering Feature Information

Features such as the phonebook and datebook require you to enter information to fill in an entry's details:

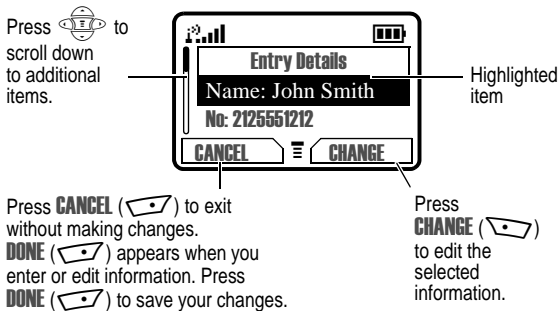

- Enter numbers or text with the keypad.
- When an item has a list of possible values, press to scroll left or to scroll right, and select a value.
- When an item has a list of possible numeric values, press a number key to set the value.
- If you enter or edit information and then decide that you do not want to save your changes, press to exit without saving.

The message centre lets you compose and send text messages. A *flashing cursor* shows where the text will appear:

Flashing cursor indicates insertion point.

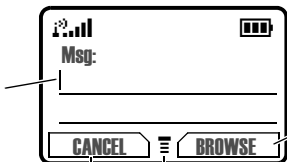

Press **BROWSE** () to view and insert a name, number, or message from previously stored information.

Press **CANCEL** () to exit without making changes.

Press  to open the sub-menu.

When you enter text, the flashing cursor changes to a *block cursor*, and the soft key functions change

Block cursor indicates current highlighted character.

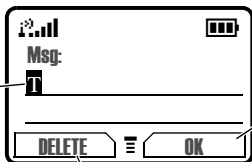

Press **OK** () to accept and store the text.

After two seconds, the block cursor reverts to a flashing cursor and moves to the next position.

Press **DELETE** () to delete the character to the left of the insertion point.

Entering Text

Various text entry methods make it easy for you to enter names, numbers, and text messages on your phone.

Choosing a Text Mode

To activate a text mode, press  > **Entry Method** from any text entry screen and select the text mode:

ITAP	Let the phone predict each word as you enter it, then choose the word from a list (see page 41).
Tap Method	Enter characters one at a time by pressing the key for the letter, number, or symbol (see below). This is the standard mode for entering text on your phone.
Numeric	Enter numbers only.
Symbol	Enter symbols only (see page 40).
Browse	Browse through your phonebook and recent calls lists to select a name or number to enter.

Note: *The text mode you select remains active until you change it by selecting another mode.*

Using Tap Method

Tap method is the default standard mode for entering text on your phone.

To activate tap method from any text entry screen, press  and select the **Tap Method** menu option.

To enter text using the tap method:

Do This	To
1 Press a number key one or more times	cycle through the characters associated with the key and select the character you want (see page 40).

Do This

2 Continue to press number keys

To











enter the rest of the characters in the text message.

3 Press **OK** ()

accept and store the text when you are finished.

Character Chart

Use this chart as a guide for entering spaces, numbers, letters, symbols, and other characters with the **Tap Method** text mode. Press the same key repeatedly to cycle through available characters.

	space . 1 ? ! , @ _ & ~ : ; " - () ' ` ¡ ¨ £ \$ ¥ ¤ €
	a b c 2 ä å á à â ã α ó β ç
	d e f 3 δ ë é è ê ε é φ
	g h i 4 ï í î γ η ή ι í
	j k l 5 κ λ
	m n o 6 ñ ö ø ó ò ô õ μ ν ω ώ
	p q r s 7 π β σ
	t u v 8 θ ü ú ù û τ
	w x y z 9 ξ ψ
	+ - 0 x * / \ [] = > < # §

Note: Your phone model may not include all of the characters shown in this chart.

General Text Entry Rules

Press a number key as many times as necessary to enter the desired character at the flashing cursor location.

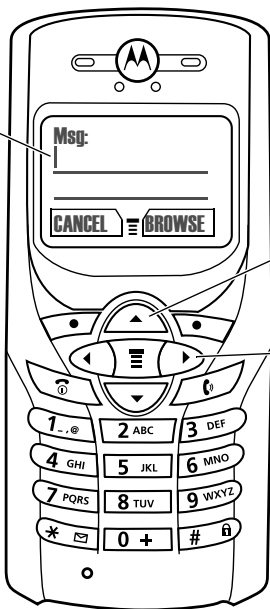

Press up or down to change character in block cursor to uppercase or lowercase.

Press and hold a number key to cycle between text entry modes.

Press left or right to move flashing cursor to the left or right in text message.

- If you do not press a key for two seconds, the character in the block cursor is accepted, and the cursor moves to the next position.
- The first character of each sentence is capitalised unless you manually change it. (Press  up or down to change the character to upper or lower case while it is highlighted.)

Use Symbol Mode

Your phone provides an alternative way to find and enter symbol characters in a text message. You can view and select from a variety of available symbols.

To activate symbol mode from any text entry screen, press  and select the **Symbol** menu option.

To enter a symbol in symbol mode:



Do This

- 1 Press a number key one time

To

display its symbol options (See page 41.)

The symbols associated with the key you pressed are shown at the bottom of the display. If necessary, press other keypad keys to find the symbol you want.

-
- 2 Scroll left or right with   or



or

Press the number key multiple times

highlight the symbol you want

-
- 3 Press **SELECT** ()

add the highlighted symbol to the text area at the top of the display

Symbol Chart

Use this chart as a guide for entering symbols in symbol mode.

1 - 0	space . ? ! , @ _ & ~ : ; " - () ' ¿ ¡ % £ \$ ¥ ¤ €
2 abc	@ _ \
3 xyz	/ : ;
4 mno	" & '
5 jkl	() [] { }
6 pqrs	¿ ¡ ~
7 tuvw	< > =
8 uvw	\$ £ ¥ ¤ €
9 wxyz	# % *
0 +	+ - x * / = > < # §

Use iTAP™ Software Predictive Text Entry

iTAP™ software provides a predictive text entry method that lets you enter the letters of a word using only one keypress per letter.

You must activate iTAP software prior to entering letters. You can do this from any text entry screen by pressing **⌘** to open the **Entry Method** menu and selecting the **iTAP** menu option.

Enter Words

Do This

- 1 Press a number key one time

To

enter the first letter of the word
The letters associated with the key you pressed are shown at the bottom of the display.

- 2 Press number keys (one per letter)

enter the rest of the word
Alternative words and letter combinations are shown at the bottom of the display based on the keys you press. These word choices are updated with each keypress.



- 3 When you have entered all the letters of the word, press  right or left

locate and highlight the word you want

- 4 Press **SELECT** ()

add the highlighted word to the text area at the top of the display

A space is automatically inserted after the word.

For example, to spell “art,” press   . The display shows:

Flashing cursor indicates insertion point.

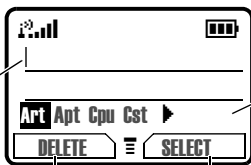

Press  to scroll and see additional word choices.

Press **DELETE** () to clear the last letter entered.

Press **SELECT** () to insert the highlighted word.

Enter Novel Words

You may enter a word that the iTAP software does not recognise. If the word is not displayed:

Do This

1 Press **DELETE** () one or more times

2 Press 

3 Press **SELECT** (), then press  to the left

4 Continue to enter letters and highlight letter combinations

To

delete letters until you see a letter combination that matches the start of the word

highlight the letter or letter combination

shift the text entry cursor to the left and “lock” the selected word portion

spell the word



Your phone stores the unrecognised word, and includes it in the list of alternative word choices the next time you enter it. When memory space for storing unrecognised words is filled, your phone deletes the oldest words as new words are added.

Enter Punctuation

Press

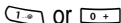

To

enter punctuation or other characters as shown on page 38

Use Capitalisation

The first word of a sentence is automatically capitalised, with following words in lowercase.

Press

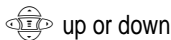

To

change the words to initial character capitalised, all uppercase characters, or all lowercase characters

Enter Numbers

Do This

1 Enter the first digit and then highlight it

To

put the iTAP software in number entry mode

2 Press number keys



add digits to the number

3 Press **SELECT** ()

enter the number at the flashing cursor location



Delete Letters and Words

Place the cursor to the right of the text you want to delete, and then do the following:

Do This	To
Press DELETE ()	delete one letter at a time
Hold DELETE ()	delete the entire message

Changing the Zoom Setting

You can set your phone's display to show either three lines or two lines of text plus soft key labels. Three lines of text display more information, while two lines increase text size.

To change the display view, press  once, then press and hold  again within two seconds of the first press.

Setting Up Your Phone

Setting the Time and Date

You must set the time and date to use the datebook.

Find the Feature

 > **More** > **Settings**
> **Other Settings**
> **Initial Setup** > **Time and Date**

Note: When you remove the phone battery, the stored time and date is displayed the next time you turn the phone on. You may need to reset the time and date, depending on how long the phone is without power.

Changing Personal Greetings



To change the text displayed when you turn on your phone:

Find the Feature

 > **More** > **Settings**
> **Other Settings** > **Personalise**
> **Greeting**

Choosing Alert and Ring Tones

Your phone rings or vibrates to notify you of an incoming call, message, or other event. This ring or vibration is called an *alert*. You can select one of five different alert profiles:

 Loud ring

 Soft ring

 Vibrate

 Vibrate and ring

 Silent

The alert setting indicator in your display shows the current alert profile (see illustration on page 31).

Each alert profile contains settings for ring tone and keypad volume. It also includes alert tone settings for different events: incoming calls, text messages, voicemail messages, data calls, alarms, and reminders. You can modify the settings in each profile.

Note: To create your own alert tones, see page 129. To download sounds to use as your alert tones, see page 122.

Select an Alert Profile

Find the Feature

 > **Ring Styles > Alert**

Press

1 

To

scroll to the alert profile you want to use

2 **SELECT** ()

select the alert profile

The phone displays the **Changed: Alert** message.

Customise an Alert Profile

You can customise a profile by changing the alerts used for specific events (such as incoming calls, text messages, etc.). Your phone includes a variety of preset alert tones and vibrations. Any changes you make are saved to the current alert profile.

Note: This feature also lets you set the profile's ring tone volume and keypad volume.

Find the Feature

 > **Ring Styles**
> **Alert Detail**

Press

1 

To

scroll to the event for which you want to set a new alert

2 **CHANGE** ()

select the event

The phone displays the list of available alerts.

3 

scroll to the alert you want for the event

4 **SELECT** ()

select the alert

Setting Your Backlight

You can set the amount of time that the display backlight remains on, or turn off the backlight to conserve battery power:

Find the Feature

 > **More** > **Settings**
> **Other Settings**
> **Initial Setup** > **Backlight**

Setting Your Contrast

You can set the amount of contrast in your display:

Find the Feature

 > **More** > **Settings**
> **Other Settings**
> **Initial Setup** > **Contrast**

Setting Your Display Colour

You can select the colour palette that your phone uses to display indicators, highlights, and soft key labels:

Find the Feature

 > **More** > **Settings**
> **Other Settings** > **Personalise**
> **Colour Style**

Setting Your Display Scrolling

You can set the cursor to stop or wrap around when it reaches the top or bottom of a list in the display:

Find the Feature

 > **More** > **Settings**
> **Other Settings**
> **Initial Setup** > **Scroll**

Setting Display Animation

You can turn animation off (to conserve the battery) or on. Animation makes your phone's menus move smoothly as you scroll up and down.

Find the Feature

 > **More** > **Settings**
> **Other Settings**
> **Initial Setup** > **Animation**

Setting Battery Save

To adjust the phone's power usage to conserve power

Find the Feature

 > **More** > **Settings**
> **Other Settings**
> **Initial Setup** > **Battery Save**

Setting Wallpaper and Screen Saver

You can use the picture viewer to select a wallpaper or screen saver image (see page 124). You can also download new pictures and animations to use as your wallpaper or screen saver images (see page 122).

Resetting All Options

To reset all options back to their factory settings except for the unlock code, security code, and lifetime timer:

Find the Feature

 > **More** > **Settings**
> **Other Settings**
> **Initial Setup** > **Master Reset**

Clearing All Information

To reset all options back to their factory settings *and* clear all user entries (such as Phonebook entries and downloaded wallpapers, screen savers, and sounds):

Warning: This option erases all user-entered information stored in your phone's memory, including phonebook and datebook entries and downloaded files. Once you erase the information, it cannot be recovered. It resets all options back to their factory settings except for the unlock code, security code, and lifetime timer.

Find the Feature

 > **More** > **Settings**
> **Other Settings**
> **Initial Setup** > **Master Clear**

Setting Up Your Phone for Hands-Free Use

A phone headset lets you use your phone without using your hands.



You can also purchase an optional Motorola Original™ Easy-Install Hands-Free Kit for your car. This accessory provides an alternative way for you to use your phone without using your handset.

Note: *The use of wireless devices and their accessories may be prohibited or restricted in certain areas. Always obey the laws and regulations on the use of these products.*

Automatic Answer

When you activate automatic answer and connect your phone to the Easy-Install Hands-Free Kit or phone headset, your phone automatically answers calls after two rings.

Find the Feature

 > **More** > **Settings**
> **Other Settings**
> **Car Settings** or **Headset**
> **Auto Answer**

Automatic Hands-Free

You can set up your phone to automatically route calls to the Easy-Install Hands-Free Kit when it detects a connection.

Find the Feature

-  > **More** > **Settings**
- > **Other Settings**
- > **Car Settings**
- > **Auto Handsfree**

Calling Features

This chapter describes features related to making and answering calls. For information about other call-related features, see page 55 and page 101. For basic instructions on how to make and answer calls, see page 27.

Displaying Your Phone Number

From the idle display:

Press



To

see your phone number

Your phone number must be programmed on your SIM card in order to use this feature.

While you are on a call:

Do This	To
Press  > My Tel. Numbers	see your phone number

Redialling a Number

You can redial a previously dialled phone number, whether the call was connected or busy. From the idle display:

Press



To

go directly to the dialled calls list



scroll to the entry you want to call

Press

3 

To

redial the highlighted number

Using Caller ID



The *calling line identification* (caller ID) feature lets you see who is calling before you answer.

- If the caller's name is stored in your phonebook, the phone automatically displays the **Name** (or **Icon ID** and a distinctive **Ringer ID**, when one is assigned). Otherwise, the phone displays the caller's phone number. To create or change a phonebook entry, see page 80.
- If caller ID information is not available, your phone displays the message **Incoming Call**.
- **Outgoing Calls:** Other phones can display your phone number when you call them or send a message. To hide your number for the next call or message, press **☰** > **More** > **Settings** > **In-Call Setup** > **My Caller ID** > **Next Call Only**.

Terminating an Incoming Call

While the phone is ringing or vibrating:

Press

IGNORE 

To

cancel the incoming call



Depending on your phone settings and the type of subscription you have, the call may be diverted to another number, or the caller may hear a busy signal.

Dialling an Emergency Number

Your service provider programs one or more emergency phone numbers (such as 999) that you can call under any circumstances. You can dial and call the emergency number even when your phone is locked, when you are prompted to enter a code or password, when the SIM card is not inserted in your phone, or when the SIM card is blocked or disabled.

Note: *Emergency numbers vary by country. Your phone's emergency number(s) may not work in all locations.*

To call the emergency number at any time:

Press	To
1 keypad keys	dial the emergency number
2 	call the emergency number

Dialling International Numbers

To dial the local international access code:

Do This	To
Press  for two seconds	insert the international access code for the country from which you are dialling

Inserting Special Characters into Dialling Sequences

In addition to pressing numbers on your keypad, you can insert special characters in a phone number.

While dialling (with digits visible in the display), you can press  and insert one of the following:

Option	Description
Insert Pause (inserts a p)	Your phone waits until the call connects before it dials the next digit(s) in the series
Insert Wait (inserts a w)	Your phone waits until the call connects, then prompts you for confirmation before it dials the next digit(s)
Insert 'n' (inserts an n)	Your phone prompts you for a number before dialling the call. The number you enter is inserted into the dialling sequence in place of the ■

Note: You can insert characters in Phonebook entries.

Viewing the Received Calls or Dialed Calls List

Your phone keeps lists of the numbers from calls you recently received and dialled, even if the calls did not connect. The lists are sorted from newest to oldest entries. The oldest entries are deleted as new ones are added. Each entry tells you the person's number (or name, if available) and whether the call connected or not. You can call, store, or delete the numbers on these lists.

Shortcut: Press  to go directly to the dialled calls list from the idle display.

To open the recent calls menu:

Find the Feature

 > **Recent Calls**

Press

1 

2 **SELECT** ()

3 

4 

or



or



To

scroll to **Received Calls** or **Dialled Calls**

select **Received Calls** or **Dialled Calls**

scroll to an entry you want to call, store, or delete

Note: ✓ means the call connected.

call the entry's number



Note: Press and hold  for two seconds to send the entry number as DTMF tones. To activate DTMF tones, see page 98.

if **View** appears above the  key—view the entry's details

if **Store** appears above the  key—store the entry's details in the phonebook

open the **Last Calls Menu** to perform other procedures as described in the following list

The **Last Calls Menu** can include the following options:

Option	Description
Store	Create a phonebook entry with the selected number in the No. field. (This option does not appear if STORE appears above the  key, or if the number is already stored as a phonebook entry.)
Delete	Delete the entry. (This option does not appear if DELETE appears above the  key.)
Delete All	Delete all entries in the current list.
Hide ID/Show ID	Hide (or show) your caller ID for the next call.
Send Message	Create a new text message, with the selected number in the Tel No. field. See page 71.
Add Digits	Add digits to the end of the selected number.
Attach Number	Attach another number from the phonebook or recent calls list to the end of the selected number.
Send Tones	Send the selected number to the network as DTMF tones, for credit card calling or password entry. (This option is available only during an active call.) To activate DTMF tones, see page 98.

Option	Description
Talk then Fax	Tell the network you want to call and talk to someone, and then send a fax—all to the same number in the same call. See page 101.

Returning an Unanswered Call

Your phone keeps a record of your unanswered calls. When you cannot answer a call, your phone displays:

- the  (missed call) indicator
- the message **X Missed Calls**, where *X* is the total number of missed calls

Press

1  **VIEW** ()

To

see the received calls list, beginning with the most recent call

2 

scroll through the list and select a call that you want to return

3 

make the call

Entering Numbers in the Notepad

Your phone stores the most recent string of digits entered on the keypad in a temporary memory location called the *notepad*. These digits can be the last phone number that you called, or a phone number that you simply entered but did not call. These digits remain in the notepad even when you turn off the phone.

To call the number, create a phonebook entry, or perform other operations with the number stored in the notepad:

Find the Feature

 > **Recent Calls** > **Notepad**

Press



or



or

STORE ()

To

call the number

open the **Dialling Menu** to attach a number or insert a special character (see page 54)

create a new phonebook entry, with the notepad number copied into the **No.** field (see page 80)

Attaching a Number

You can attach a number from your phonebook or recent calls list to the digits you enter in the display.

While dialling (with digits visible in the display):

Do This	To
Press  > Attach Number	attach a number from the phonebook or recent calls list to the end of the digits you entered

Using Voicemail



You can listen to your voicemail messages by calling your network voicemail phone number. Voicemail messages are stored on the network—not on your phone. Contact your service provider for more details.

Storing Your Voicemail Number

Store your voicemail number in your phone to make it faster and easier to use voicemail. Your voicemail number is provided by your service provider.

Find the Feature

 > **More** > **Messages**
 > **VoiceMail Setup**

Press

1 keypad keys

To

enter the phone number for your voicemail

2 **OK** ()

store the number

Receiving a New Voicemail Message

When you receive a voicemail message, your phone displays **New VoiceMail** . (Some networks only indicate when you have messages, whether they are new or not.) If reminders are turned on, your phone sends a reminder every five minutes until you close the new message notification, listen to the message, or turn off your phone. (See page 117.)

From the new message notification:

Do This

Press **CALL** ()

To

call the voicemail phone number you stored and listen to the message

Listening to a Voicemail Message

Once you store your voicemail number, you can listen to your voicemail messages at any time:

Find the Feature



 > **More** > **Messages**
> **VoiceMail**

Your phone calls the voicemail phone number you stored. If you do not have a voicemail number stored, the phone guides you through storing a number.

Speed Dialling

Speed dial lets you dial any phonebook entry with a minimal number of keypresses.

When you store an entry in your phonebook, it is assigned a unique speed dial number. You can then use the speed dial feature to call the entry. In the idle display:

Press	To
1 keypad keys	enter the speed dial number for the entry you want to dial
2 	submit the number
3 	call the entry

To make an entry in the phonebook or view an existing entry's speed dial number, see page 80.

One-Touch Dialling

You can call phonebook entries 1 to 9 with the push of a single key. Press and hold the one-digit speed dial number for one second. To store entries in locations 1 to 9 in the phonebook, see page 80.

You must assign the 1-touch dial feature to numbers 1 to 9 in your phone memory phonebook or SIM card phonebook:

Find the Feature

 > **More** > **Settings**
> **Other Settings**
> **Initial Setup** > **1-Touch Dial**

Note: Your service provider may assign entry 1 to your voicemail number.

Quick Dialling



You can dial pre-programmed numbers stored on your phone. Your service provider may program your phone with one or more quick dial numbers, such as the customer service number. You can call them by selecting them from the quick dial list.

Find the Feature

 > **More** > **Quick Dial**

Note: Your service provider may use a different name for this feature.

To change your quick dial numbers:

Find the Feature

 > **More** > **Settings**
> **Other Settings** > **Personalise**
> **Quick Dial**

Using Call Waiting



If you subscribe to call waiting, an alert tone sounds while you are on a call to indicate that you have received a second call. To put the first call on hold and answer the second call, press . To put the first call on hold and answer the second call:

Press

1 

2 **SWITCH** ()

To

answer the new call

switch back to the first call

Note: You can press **SWITCH** () at any time to switch between calls.

or

LINK ()

connect the two calls

To end the first call and answer the second call:

Press



To

end the current call

Your phone rings to signal the new call.



answer the new call

To activate or deactivate call waiting:

Find the Feature

 > **More** > **Settings**
> **In-Call Setup** > **Call Waiting**

Diverting a Call



Call diverting sends your phone's incoming voice, fax, and/or data calls directly to another phone number.











Set Up or Cancel Call Diverting

The diverting options for voice, fax, or data calls are:

All Calls	diverts all calls
If Unavailable	divert calls if your phone is unavailable
Detailed	set different diverting numbers if you are out of range, unable to answer, or busy (<i>voice calls only</i>)
Off	do not divert calls

Find the Feature

 > **More** > **Settings**
> **Call Divert**

Press	To
1 	scroll to the type of calls you want to divert
	Scroll to Cancel All to cancel all call diverting.
2 SELECT ()	view call diverting details
3 	scroll to Divert
4 CHANGE ()	change the Divert option
5 	scroll to a diverting option
6 SELECT ()	store the option
7 	scroll to To (for Detailed diverting, scroll to If Busy , If No Answer , or If Unreachable)
8 CHANGE ()	select To
9 keypad keys	enter the diverting phone number
or	
BROWSE ()	select a number from the phonebook or recent call lists
10 OK ()	store the number
11 DONE ()	save call diverting settings

Note: Repeat this procedure to enter diverting information for other call types.



Check Call Diverting Status

Your network may store call diverting status for you. If you change your phone's call divert settings, then you should confirm that the network call divert status matches your preferences.

Find the Feature

 > **More** > **Settings**
> **Call Divert**
> **Divert Status**

Press

- 1 
- 2 **View** ()

To

scroll to **Voice, Fax, or Data** calls



confirm that the network settings are correct

Linking Calls



To talk to more than one person on a call, you can make a conference call. Call the first person, call the second person, then link the two calls.

Press

- 1 keypad keys
- 2 
- 3 **HOLD** ()
(if available) or
 > **Hold**

To

dial the first person's number

call the number

put the first call on hold

Your phone displays a  (flashing phone) indicator next to the call on hold.

- 4 keypad keys

dial the next person's number

Press5 **To**

call the number

Your phone displays a  (active call) indicator next to the new active call.

6 **LINK** ()

connect the two calls

7 

end the entire call

Transferring a Call

While you are on a call, you can transfer the call to another phone by first talking to the person who answers the other phone, or by directly transferring the call.

Announce the Call Transfer

You can talk to the person who answers the other phone before you transfer the call, to tell them whom you are transferring.

Find the Feature > **Hold****Press**

1 keypad keys

To

enter the phone number where you are transferring the call

2 

dial the phone number

Speak to the person who answers the target phone.

3 

open the menu

4 scroll to **Transfer**5 **SELECT** ()select **Transfer**

Press6 OK **To**

confirm the transfer

Your phone displays the message **Transfer: Complete** when the call is transferred. You can hang up the phone when you see this message.

Do Not Announce the Call Transfer

You can directly transfer a call without talking to the person who answers. During a call:

Find the Feature > **Transfer****Press**

1 keypad keys

To

enter the phone number where you are transferring the call

2 

dial the phone number

Your phone displays the message **Transfer: Complete** when the call is transferred. You can hang up the phone when you see this message.





Barring a Call



Call barring lets you restrict outgoing or incoming calls. You can restrict all calls, calls to international numbers, or calls while roaming, or all calls but home.



Find the Feature

 > **More** > **Settings**
> **Security**
> **Call Barring**

Press	To
1 	scroll to Outgoing or Incoming calls
2 CHANGE ()	select barring for Outgoing or Incoming calls
3 	scroll to a restriction for the barred calls
4 SELECT ()	select the restriction for the barred calls
5 keypad keys	enter your call barring password (from your network service provider)
6 OK ()	submit your password

Putting a Call on Hold

While you are on a call:

Press	To
HOLD () (if available) or  > Hold	put a call on hold Your phone displays a  (flashing phone) indicator to indicate that the call is on hold.

Messages



You can send and receive text messages, pictures, and ring tones on your wireless phone. Received messages appear on your phone display or in your text message inbox.

You must set up the text message inbox *before* you can send and receive these messages. The total number of messages the inbox can hold depends on the length of the messages, and the number of other messages and drafts stored in your phone.

Note: Your service provider may have already programmed the text message inbox settings for you.

Setting Up the Text Message Inbox

Find the Feature

 > **More** > **Messages**

 > **Text Msg Setup**

Press

1 

2 **CHANGE** ()

3 keypad keys

4 **OK** ()

5 **CHANGE** ()

To











scroll to **Srvce Centre No.**

change the **Srvce Centre No.** which is provided by your service provider

enter the phone number for the service centre that handles your outgoing messages

store your service centre number

change the **Expire After** period

Press	To
6 keypad keys	enter the expiry period—the number of days your network tries to resend unreceived messages
7 OK ()	store the expiry period
8 CHANGE ()	change the Reply Type
9 	scroll to the default type of replies you want to send—text messages, or other formats
10 OK ()	store the reply type
11 CHANGE ()	change the Cleanup setting
12 	scroll to the period of time that messages stay in your inbox
13 SELECT ()	select the cleanup period If you select Custom , continue. Otherwise, the procedure is complete.
14 	change the entry for the number or label
15 	switch between the number and the label
16 DONE ()	store the custom cleanup period after you finish entering all information

Sending Messages, Pictures, and Ring Tones

You can send text messages, pictures, and ring tones to one or more recipients. You can manually enter each recipient's phone number, or select one or more numbers from the phonebook or recent calls lists.

Note: *The recipient's phone may be unable to display pictures or ring tones inserted in your message.*

Shortcut: While dialling (with digits visible in the display), you can Press  > **Send Message** to create a text message addressed to the number entered.

When you manually enter multiple phone numbers in the **To** field, you must insert a space between each number. Press and hold  to insert a space as needed.

Find the Feature

 > **More** > **Messages**

 > **Create Message**

Press

1 keypad keys

To

enter the text message

To insert a picture, animation, or sound file in the message, press:

 > **Insert** > *object type*
> *object*

Note: *Message length is limited. When you near the limit, a two-digit counter at the top of the display shows how many characters are left.*

2 **OK** ()

store the text message

Press

3 keypad keys

To

enter one or more phone numbers where you want to send the message

Note: Press and hold  to add a space between numbers that you enter manually.

or

BROWSE 

select one or more phone numbers from the phonebook or recent calls lists

4 **OK** 

store the number(s)

5 **DONE** 

finish the message

6 

scroll to **Send Message**, **Message Details**, **Save to Drafts**, or **Cancel Message**

7 **SELECT** 

select the option

Viewing Message Status

Text messages that you send are stored in the outbox. To view the contents of your outbox:

Find the Feature

 > **More** > **Messages**
> **Outbox**

Messages are sorted from newest to oldest. The following icons indicate message status:

» = sending in progress

 = delivered

✘ = sending failed

Receiving a Text Message

Note: Your text message inbox must be set up before you can receive text messages. See page 69.

When you receive a text message, your phone displays **New Message**  and gives an alert.

Press

READ ()

To

open the message

If reminders are turned on, your phone sends a reminder at regular intervals until you close the new message notification, read the message, or turn off your phone. (See page 117.)

When your inbox is full, flashing envelope icon appears. New messages do not appear until you delete some existing ones.

Reading, Locking, or Deleting a Text Message

Messages in the text message inbox are sorted from newest to oldest. The oldest messages are deleted automatically as specified by the inbox cleanup setting. If you want to save a message, you should lock it to prevent it from being deleted during cleanup.

Find the Feature

 > **More** > **Messages**
> **Text Msgs**



Press

1 

To

scroll to the message you want

( = unread,

 = read,  = read and locked)

2 **READ** ()

open the message

Press

3 BACK ()

or

REPLY ()

or



To

close the message

compose and send a reply

open the **Text Msg Menu** to perform other procedures as described in the following list

The **Text Msg Menu** can include the following options:

Option	Description
Delete	Delete the message.
Call Back	Call the number in the message header or embedded in the message.
Reply	Open a new text message, with the sender's Reply To number or email address in the To field.
Forward	Open a copy of the text message, with an empty To field.  <i>Note: You cannot forward sound files embedded in a text message. Only the text is forwarded.</i>
Lock/Unlock	Lock or unlock the message.

Option	Description
Store	Store a phone number listed in a message, or store a picture, animation, or ring tone attachment. When you store a message attachment, you can optionally set it as a screen saver image, wallpaper image, or ring tone.
Delete All	Delete all inbox messages.
New Message	Open a new text message.
Setup	Open the text message inbox setup menu.

Using Chat



You can exchange text messages in real time with another wireless phone user in a *chat session*. The messages you send appear immediately on your chat partner's phone.

Start a Chat Session

Find the Feature

 > **Chat**

 > **New Chat**

Press







To

1 keypad keys

enter your **Chat Name**

2 **OK** ()

save your **Chat Name**

Press	To
3 keypad keys	enter your chat partner's phone number
or	
BROWSE ()	select a number from the phonebook or recent call lists
<hr/>	
4 OK ()	store the number
<hr/>	
5 keypad keys	enter your first chat message
or	
INSERT ()	select a quick note
<hr/>	
6 OK ()	send the chat message
	When your chat partner replies, the reply appears below your text.
<hr/>	
7 CHAT ()	enter a reply to your partner
<hr/>	
8 OK ()	send your reply

Notes:

- You can start a chat session from a text message. Press  and select **Chat** to start a new session with the sender's **Reply To** number in the **To** field.
- When your phone displays **Memory is Full!**, you must delete some existing messages from your inbox, outbox, or drafts folder to receive new chat messages.

Use the Chat Log

The chat log displays the messages exchanged in a chat session.

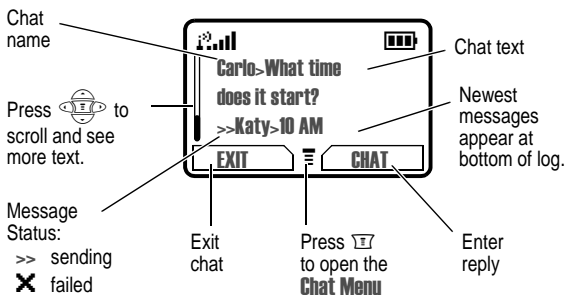



Use the Chat Menu

During a chat session, you can press **[F7]** to open the **Chat Menu** to perform procedures as described in the following list:

Option	Description
New Chat	Open a new chat session.
Call Partner	Call your chat partner.
Call Number	Call the number listed in the chat log.
Store Number	Create a phonebook entry for the number listed in the chat log.
End Chat	End the chat session.
Go to Top	Go to the top of the chat log.
Go to Bottom	Go to the bottom of the chat log.
Clear Log	Clear all text from the chat log.
Re-send	Resend your most recent chat message, if it failed.
Send Message	Create a new chat message.

Respond to Chat





When you receive a chat message, your phone displays **Chat from** *chat name*, and gives an alert.

Press	To
ACCEPT ()	accept the chat session
IGNORE ()	refuse the chat session

If reminders are turned on, your phone sends a reminder at regular intervals until you respond to the chat notification or turn off your phone.

If you receive another chat request during a chat session, the new request appears as an incoming text message, with the requestor's *chat name* at the beginning of the message.

End a Chat Session

Press	To
1 	open the Chat Menu
2 	scroll to End Chat
3 SELECT ()	select End Chat
4 YES ()	end the chat session

A chat session also ends when you turn off the phone, answer an incoming call, or start a new chat session.

Your chat partner is not notified when you end a chat session. If your partner sends more chat text, the phone treats it as an incoming text message, with your chat partner's *chat name* at the beginning of the message.

If you exit the chat log without selecting **End Chat**, and your chat partner sends another message, your phone notifies you and adds it to the chat log. You can re-enter the session by returning to the chat log.

Phonebook

You can store a list of names and phone numbers or email addresses in your phone's electronic phonebook.

To see the list of names stored in your phonebook, press **VIEW** > **More** > **Phonebook** from the idle display. Scroll to a name and press **VIEW** () to view details of the phonebook entry as shown below.

Shortcut: Press  up or down from the idle display to open the phonebook.

Viewing Entry Details

Type indicator shows number type:

-  Work
-  Home
-  Main
-  Mobile
-  Fax
-  Pager
-  Email

Voice Name indicator indicates a recorded voice name

Entry's Name

Phone number, email address, or mailing list members.

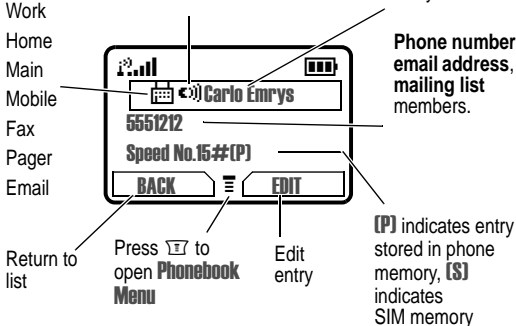

Notes:

- **Email Address** entries, **Mailing List** entries, and entries stored on the SIM card do not have **Type**, **Voice Name**, **Icon ID**, or **Ringer ID** information.

- If the phonebook entry is a mailing list, list members are listed after the entry's name.
- When you set a distinctive ringer alert for an entry, the **Ringer ID** setting appears below the speed dial number.

Storing a Phonebook Entry

A phone number or email address is required for a phonebook entry. All other information is optional.



For email addresses, you can send a text message directly from your phone.

You can store a phonebook entry on your phone or on the SIM card. Entries with a speed dial number from 1 to 100 are stored on the phone. 101 and above are stored on the SIM.

Shortcut: Enter a phone number in the idle display, then press **STORE** () to create a phonebook entry with the number in the **No.** field. Go directly to step 3 in the following procedure to enter additional information and store the entry.

Note: You can also use the following procedure to store a fixed dial entry by scrolling to and selecting **Fixed Dial**.

Enter Information

Find the Feature

> More > Phonebook

> New

Press

1

To









scroll to **Phone Number**,
Email Address, or **Mailing List**







2 **SELECT** ()

select the type of entry

3 **CHANGE** ()

select **Name**

Press	To
4 keypad keys	enter a name for the phonebook entry (see page 36)
5 OK ()	store the name
6 CHANGE ()	select No. , Email , or Members
	<p>Note: If you select Members (for a Mailing List), a list of phonebook entries appears.</p> <ol style="list-style-type: none"> Press  to scroll to an entry. Press ADD () or REMOVE () Press DONE () when you are finished. You can skip to step 12 below.
7 keypad keys	enter the phone number or email address
8 OK ()	store the phone number or email address
9 CHANGE ()	select Type
	<p>Notes:</p> <ul style="list-style-type: none"> Your phone automatically applies an  (email) type indicator when you enter an email address. This option is not available for email entries, or for entries stored on the SIM card.

Press	To
10 	scroll to the type of phone number
11 SELECT ()	select the number type
12 RECORD () or Go to step 13 if you do not want to record a voice name for the entry	record a voice name for the entry, if desired See page 84. Note: <i>This option is not available for entries stored on the SIM card.</i>
13 	scroll to Speed No. , the number to <i>speed dial</i> the entry The next available speed dial number is assigned to a new phonebook number by default. Entries 101 and above are stored on the SIM.
14 CHANGE ()	select Speed No. if you want to change it
15 keypad keys	enter a different speed number, if desired
16 OK ()	save the modified speed number If your chosen speed number is already assigned to another entry, you are asked if you want to replace that entry.
17 CHANGE ()	select Ringer ID Note: <i>This option is not available for entries stored on the SIM card.</i>

Press**To**

scroll to the ring tone that should sound when you receive calls or messages from this entry

Note: To activate ringer IDs, see page 93.

19 SELECT 

select the ring tone

20 CHANGE select **Icon ID**

Note: This option is not available for entries stored on the SIM card.



scroll to the icon that should appear when you receive calls or messages from this entry

22 SELECT 

select the icon

23 SELECT 

select **MORE** if you want to create another entry with the same **Name**

Note: You must enter a name and number to use this option.

Complete Phonebook Entry

When you are finished entering information for a phonebook entry:

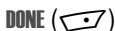
Press**To**

store the entry

Recording a Voice Name For a Phonebook Entry

You can record a voice name for a new or existing phonebook entry. A voice name lets you call the phonebook entry using voice dial (see page 85).

Note: You cannot record a voice name for an entry stored on the SIM card.







Make your voice recording in a quiet location. Hold the phone about four inches (10 centimetres) from your mouth, and speak directly into the phone in a normal tone of voice.

Find the Feature

 > More > Phonebook

Do This

To

- | | | |
|---|---|--|
| 1 | Press  | scroll to the entry that needs a voice name |
| 2 | Press VIEW () | display the entry's detailed view |
| 3 | Press EDIT () | edit the phonebook entry |
| 4 | Press  | scroll to Voice Name |
| 5 | Press RECORD () | begin the recording process
The phone displays Press RECORD Key then say name. |
| 6 | Press and release RECORD ()
then say the entry's name (in two seconds) | record the voice name
The phone displays Press RECORD Key then REPEAT name. |
| 7 | Press and release RECORD ()
then repeat the name | confirm the voice name
The phone displays Trained: Voice Name. |

Dialling a Phonebook Entry

You can use the phonebook list, voice dial, speed dial, or 1-touch dial to call a number stored in your phonebook. To use speed dial, see page 61. To use 1-touch dial, see page 61.

Phonebook List

Find the Feature

 > More > Phonebook

Press

To

1 

scroll to the entry you want

2 

call the entry

Shortcut: In idle, press  up or down to open the Phonebook.

Voice Dial

Find the Feature

 > Voice Dial

Say the pre-recorded phonebook entry name.



Editing a Phonebook Entry

You can edit a phonebook entry stored on your phone or the SIM card. If you change an entry's speed dial number, the entry is moved to the new speed dial location and the original entry is deleted.

Note: You can also use the following procedure to edit a fixed dial entry by scrolling to and selecting **Fix Dial**.

Find the Feature

 > More > Phonebook

Press	To
1 	scroll to the entry you want to edit
2 VIEW ()	display the entry's detailed view
3 EDIT ()	edit the phonebook entry





For a description of the items in a phonebook entry or fixed dial entry, see page 79 and page 80.

Deleting a Phonebook Entry

To delete a phonebook entry:

Find the Feature

 > **More** > **Phonebook**

Press	To
1 	scroll to the entry you want to delete
2 	open the Phonebook Menu
3 	scroll to Delete
4 SELECT ()	select Delete

Sorting Phonebook Entries







You can set up your phone to sort your phonebook list by speed dial number (the standard), name, or voice dial.

Note: The voice dial sort is identical to the name sort, except that the entries with voice name tags appear first.

Find the Feature

 > **More** > **Phonebook**

Press	To
1 	open the Phonebook Menu

Press	To
2 	scroll to Setup
3 SELECT ()	select Setup
4 	scroll to Sort by
5 CHANGE ()	select Sort by
6 	scroll to the entry you want
7 SELECT ()	select the entry you want

Copying Phonebook Entries

You can copy one or more phonebook entries from your phone to the SIM card or from the SIM card to your phone.

Notes:

- *This procedure copies the original entry to a new location. It does not delete the original entry.*
- *The SIM card cannot store **Type** and **Voice Name** data for entries. If you try to copy an entry with a type or voice name to the SIM card, the phone asks you for confirmation before dropping this information and copying the entry.*

Copy a Single Entry

To copy a single phonebook entry from your phone to the SIM card or from the SIM card to your phone:

Find the Feature

 > **More** > **Phonebook**





Press

1 

To

scroll to the entry you want to copy

***Note:** Entries with a speed dial number from 1 to 100 are stored on the phone. Entries with a speed dial number of 101 or higher are stored on the SIM card.*











2		open the Phonebook Menu
3		scroll to Copy Entry
4	SELECT ()	select Copy Entry The phone displays the Copy To form, with the next available speed dial number.
5	keypad keys	edit the speed dial number on the Copy To form
6	OK ()	approve the copy to the speed dial number The phone displays the Stored message. You can now delete the old phonebook entry, if desired.

Copy Multiple Entries

To copy multiple phonebook entries from your phone to the SIM card or from the SIM card to your phone:

Find the Feature

 > **More** > **Phonebook**

Press	To
1 	open the Phonebook Menu
2 	scroll to Copy Entries
3 SELECT ()	select Copy Entries The phone displays the Copy Entries form.
4 	scroll to From (start)
5 CHANGE ()	select From (start)
6 keypad keys	enter the first (lowest) speed dial number in the range of entries that you want to copy <i>Note: Entries with a speed dial number from 1 to 100 are stored on the phone. Entries with a speed dial number of 101 or higher are stored on the SIM card.</i>
7 OK ()	store the number and return to the Copy Entries form
8 	scroll to From (end)
9 CHANGE ()	select From (end)
10 keypad keys	enter the last (highest) speed dial number in the range of entries that you want to copy
11 OK ()	store the number and return to the Copy Entries menu
12 	scroll to To (start)
13 CHANGE ()	select To (start)

Press**14** keypad keys**To**

enter the first (lowest) new speed dial number for the entries' new location

15 **OK** ()store the number and return to the **Copy Entries** menu**16** **DONE** ()

copy the entries

The phone displays the **Copied Entries** message. You can now delete the old entries, if desired.

Checking Phonebook Capacity

You can check phonebook capacity to see how much space is left for storing phonebook entries on your phone and on the SIM card. For entries stored on the phone, your phone displays a memory meter that shows how much memory space remains to store phonebook and datebook entries. For the SIM card, your phone lists the number of phonebook entries used and the number available.

Find the Feature **> More > Phonebook****Press****1** **To**open the **Phonebook Menu****2** scroll to **Phone Capacity****3** **SELECT** ()select **Phone Capacity**

Your phone displays the phone memory meter, or the number of SIM card phonebook entries available.

Customising Your Phone Settings

You can adjust your phone's menus and features.

Reordering the Main Menu





Your service provider can change the order of menu items from what is listed in this manual. Additionally, you can also reorder the menu items.

Find the Feature

 > **More** > **Settings**
> **Other Settings** > **Personalise**
> **Main Menu**

Press

To





- | | | |
|---|---|--|
| 1 |  | scroll to the menu item you want to move |
| 2 | GRAB () | grab the menu item you want to move |
| 3 |  | move the item up or down the menu |
| 4 | INSERT () | insert the item in the new location |

Reordering the Message Centre Menu



Your service provider can change the order of Message Centre items from what is listed in this manual. Additionally, you can also reorder the menu items.

Find the Feature

 > **More** > **Messages**
 > **Reorder**





Press	To
1 	scroll to the menu item you want to move
2 GRAB ()	grab the menu item you want to move
3 	move the item up or down the menu
4 INSERT ()	insert the item in the new location

Redefining Soft Keys

You can relabel the soft keys (left  and right ) to access different main menu items from the idle display.

Find the Feature

 > **More** > **Settings**
 > **Other Settings** > **Personalise**
 > **Keys**

Press	To
1 	scroll to Left or Right
2 CHANGE ()	open the key editor
3 	scroll to the new key function
4 SELECT ()	confirm the new function The key will have the new function whenever the phone is idle.

Selecting a Different Language

You can select a different language for your phone's display:

Find the Feature

 > **More** > **Settings**
> **Other Settings**
> **Initial Setup** > **Language**

Activating Ringer IDs



When ringer IDs are turned on, your phone uses distinctive ring tones to notify you of incoming calls or messages from specific entries stored in your phonebook.

Note: To assign a ringer ID to a new or existing phonebook entry, see page 80.

Find the Feature

 > **More** > **Ring Styles**
> **Alert Detail** > **Ringer IDs**





Note: *Alert* represents the current ring style.

	Press	To
1		scroll to On or Off
2	SELECT ()	select the option

Using Shortcuts

MyMenu lets you create shortcuts to quickly access your favourite menu features, stored entries (such as phonebook or datebook entries), or URLs.

Adding a MyMenu Shortcut

Do This	To
1 Press 	enter the menu system
2 Scroll to the item you want to add to MyMenu	select the menu item, entry, or URL
3 Press and hold 	open the MyMenu editor The phone displays: Assign MyMenu for: " <i>Item</i> "? where <i>Item</i> is the name of the item you selected.
4 Press YES ()	view your options
5 Press CHANGE () or Press DONE ()	change the MyMenu key number, if necessary select the MyMenu key number and close the editor

Using a MyMenu Shortcut

You can use MyMenu from the idle display, while on a call, or while scrolling through a menu.

Use a MyMenu Key Command

If you know the MyMenu key number:

Press	To
1 	open the menu
2 the MyMenu key number	go to the menu item, or perform the menu action

Select a Shortcut From the MyMenu List

To select a feature from the MyMenu list:

Find the Feature

 > **More** > **MyMenu**
> *the feature you want*

Tip: To edit or delete a MyMenu shortcut, highlight it in the list and press  to open a menu of options for the shortcut.

Setting a Wallpaper Image

Find the Feature

 > **More** > **Settings**
> **Other Settings** > **Personalise**
> **Wallpaper**

Setting	Description
Picture	select the picture or animation for the background image in your idle display
Layout	select Centre or Tile

Setting a Screen Saver

Find the Feature

 > **More** > **Settings**
> **Other Settings** > **Personalise**
> **Screen Saver**

Setting	Description
Picture	select the picture that appears when your phone is idle
Delay	select how long your phone must be idle before the screen saver picture appears <i>Note: If this setting is longer than your Display Timeout setting, then your display will turn off before you ever see the screen saver.</i>

Getting More Out of Your Phone

Dialling Options

Fixed Dialling



When you turn on fixed dial, users can only call numbers stored in the fixed dial list.

Note: Employers can use fixed dial to limit employees' phones to a predefined list of numbers, country codes, or other prefixes.

Activating Fixed Dial

To activate fixed dial:

Find the Feature

 > **More** > **Settings**
> **Security** > **Fixed Dial**

Creating and Calling Fixed Dial Entries

Fixed dial list entries can be any length. If there is a fixed dial entry for the digits 555, users can call any number that starts with 555. You must enter your SIM PIN2 code, from your network service provider, to edit fixed dial entries. To open the fixed dial list:

Find the Feature

 > **More** > **Fixed Dial**

In the fixed dial list, you can create, edit, delete, and sort entries just like in the phonebook list. Fixed dial list entries are stored on your SIM card and do not have **Type** or **Voice Name** fields.

Service Dialling



Dial pre-programmed numbers stored on your SIM card. Your service provider may program your SIM card with numbers for services such as taxi companies, restaurants, and hospitals.

Find the Feature

 > **More** > **Service Dial**

Managing Your Calls

Calling a Number in a Text Message



If you receive a text message with an embedded phone number, you can dial the number directly.

***Note:** You must set up the text message inbox before you can receive text messages. See page 69.*

Find the Feature

 > **More** > **Messages**
> **Text Msgs**

Press

1 

To

scroll to the message with the number

2 



open the **Text Msg Menu**

3 

scroll to **Call Back**

4 **SELECT** ()

dial the number in the message

If the message contains more than one phone number, press  to scroll to a number, then press **SELECT** () to dial.

Sending DTMF Tones

While you are on a call, you can send keypresses as tones:

Do This

Press  > **Send Tones**

To

send a number to the network as DTMF tones, for credit card calling or password entry

To set DTMF tones to be long, short, or off:

Find the Feature

 > **More** > **Settings**
> **Other Settings**
> **Initial Setup** > **DTMF**

Monitoring Phone Use

Viewing and Resetting Call Timers

Your phone tracks and records call times. Use the recent calls menu to view and reset a call timer.

Network connection time is the elapsed time from the moment you connect to your service provider's network to the moment you end the call by pressing . This time includes busy signals and ringing.

The amount of network connection time you track on your resettable timer may not equal the amount of time for which you are billed by your service provider. For billing information, please contact your service provider directly.

To view a call timer:

Find the Feature

 > **Recent Calls** > **Call Times**

Press

1

**To**

scroll to the timer you want to view

2 **SELECT** ()

view the recorded time

To reset the call timer:

Press

1

RESET ()**To**

reset the time (if available)

2 **YES** ()

confirm the reset

You can view the approximate network connection time elapsed during the following calls:

Timer	Description
Last Call	Time spent on the last call dialled or received. You cannot reset this timer.
Dialled Calls	Total time spent on dialled calls since the last time you reset this timer.
Received Calls	Total time spent on calls received since the last time you reset this timer.
All Calls	Total time spent on dialled and received calls since the last time you reset this timer.
Lifetime	Total time spent on all calls on this phone. You cannot reset this timer.

Viewing and Resetting Call Costs

To view a cost tracker:

Find the Feature

 > Recent Calls > Call Cost

Press

1 

To

scroll to the cost tracker you want to view

2 **SELECT** ()

view the recorded cost

To reset the cost tracker:

Press

1 **RESET** ()

To

reset the cost (if available)

2 **OK** ()

enter your PIN2 code to confirm the reset



Your phone network can provide the following cost information:

Cost Tracker	Description
Credit Available	Amount of your credit remaining. For GSM advice-of-charge, this is only available if you set a credit limit. <i>Note: Your phone receives cost information from the advice-of-charge feature or third-party prepay software.</i>

Cost Tracker	Description
Expiry Date	Date that the available credit expires (available only with a subscription to a prepay option).
Last Deposit	Amount of the last deposit (available only with a subscription to a prepay option).
Last Call	Amount spent on the last call you dialed or received. You cannot reset this cost tracker.
Dialled Calls	Amount spent on calls you dialed since the last time you reset this cost tracker.
Received Calls	Amount spent on calls you received since the last time you reset this cost tracker.
All Calls	Amount spent on all dialled and received calls since the last time you reset this cost tracker. You can reset this value separate from Dialled Calls and Received Calls , so Dialled Calls plus Received Calls may not equal All Calls .

Network Features

Data and Fax Calls



A Motorola Original™ data kit lets you transfer data between your phone and a computer or other external device. You can:

- use your phone to make and answer data and fax calls on your computer or hand-held device.
- use your phone as a modem to connect to the Internet

***Note:** 56K modems are capable of receiving 56Kbps from a compatible service provider. Receiving is currently limited in the U.S. and Canada to 53 Kbps, and transmitting to 33.6 Kbps. Actual speeds will vary depending on line conditions.*

Your phone can use GPRS network connections when available (see page 31).

For more information about Motorola Original data kits, see the Motorola Web site at:

<http://www.hellomoto.com>

Connecting Your Phone to an External Device

Connect your phone to an external device (such as a computer or hand-held device) using a USB cable.

***Note:** Not all devices are compatible with USB cable connections. Check your external device for specifications.*

Set Up a Cable Connection

Attach a Motorola Original USB cable to the phone and external device as follows.

***Note:** Your phone requires a mini-USB connector. Check your computer or hand-held device to determine the type of cable you need.*

Do This

- 1 Plug the end of the cable with the Motorola logo into your phone's accessory connector port. Make sure that the logo and the phone are both facing you.
 - 2 Plug the other end—the USB connection—into the USB port on the external device.
-
-

Install the Software

Install the software from the CD-ROM that comes with your Motorola Original data kit. See the data kit's user guide for more information.

Making a Data or Fax Call

You can connect your phone to a computer or hand-held device to send data or a fax from the connected device.

Attach the cable (see page 102) and do the following:

Do This	To
1 Check the phone	make sure that the phone is connected and powered on
2 Open the application on your computer	place the call through the application (such as dial-up-networking) <i>Note: You cannot dial data or fax numbers through your phone's keypad. You must dial them through your computer.</i>
3 End the transfer on your computer	close the call and connection when the transfer is complete

Receiving a Data or Fax Call

You can connect your phone to a computer or hand-held device to receive data or a fax.

Use this feature to transfer data to your computer from another device.

Transfer the Data or Fax

Connect your phone (see page 102).

Your phone notifies you when the call arrives, and transfers the call to the connected device. You must use the application running on the connected device to answer the call.

End the Data/Fax Connection

When the data or fax transfer is complete:

Do This

End the call from the connected device

To

close the connection

Make a Talk and Fax Call



You can place a call where you talk and then send a fax to the same phone number within the same call.

Connect to the device that will send the fax and do the following:

Press

1 keypad keys

To

enter the phone number

2 

open the **Dialing Menu**

3 

scroll to **Talk and Fax**

4 **SELECT** ()

select **Talk and Fax**

Your selection applies to the next call only.

5 

make the call

Speak and, when ready, initiate the fax transfer on the connected device. When the transfer is complete, end the call from the connected device.

Network Selection

You can view and adjust your phone's network settings:

Find the Feature

 > **More** > **Settings**
> **Other Settings** > **Network**

Your service provider registers your phone to a network. You can view information about the current network, change how your phone searches for a network, specify your preferred networks, and activate alerts that indicate when a call is dropped or network registration changes.

Security

Locking and Unlocking Your Phone

You can lock your phone manually or set your phone to lock automatically whenever you turn it off.

When you try to use a locked phone, it asks you to enter the unlock code. A locked phone still rings or vibrates for incoming calls or messages, *but you must unlock it to answer.*

You can make emergency calls on your phone even when it is locked. See page 54.

Lock Your Phone Manually

Find the Feature

 > **More** > **Settings**
> **Security** > **Phone Lock**
> **Lock Now**

Press

1 keypad keys

2 **OK** ()

To

enter your four-digit unlock code

lock the phone

Set Your Phone to Lock Automatically

You can set your phone to lock every time you turn it off:

Find the Feature

 > **More** > **Settings**
> **Security** > **Phone Lock**
> **Automatic Lock** > **On**

Press

1 keypad keys

2 **OK** ()

To

enter your four-digit unlock code

set the phone to lock automatically

Unlock Your Phone

At the **Enter Unlock Code** prompt:

Press	To
1 keypad keys	enter your four-digit unlock code The unlock code is originally set to 1234. If necessary, see page 108.
2 OK ()	unlock your phone

Changing Your Unlock Code

Your phone's four-digit unlock code is originally set to 1234, and the six-digit security code is originally set to 000000. Your service provider may reset these numbers before you receive your phone.

If your service provider has *not* reset these numbers, we recommend that you change them to prevent other users from accessing your personal information or modifying your phone settings. The unlock code must contain four digits, and the security code must contain six digits. Be sure to make a note of the new numbers.





Notes:

- *Your service provider may retain your phone's security code for customer service purposes. In this case, you will not be able to use phone features that require you to enter the security code (such as master clear, master reset, and the unlock code bypass feature).*
- *If the only password you can change is the unlock code, the **New Passwords** menu is unavailable and the **Unlock Code** option appears on the **Phone Lock** menu. In this case, open the unlock code editor by selecting:  > **More** > **Settings** > **Security** > **Phone Lock** > **Unlock Code**.*

To change a code or password:

Find the Feature



 > **More** > **Settings**
> **Security** > **New Passwords**

Press	To
1 	scroll to the code or password you want to change
2 CHANGE (	select the code or password
3 keypad keys	enter your old code If you do not know your code, see page 108.
4 OK (	submit your old code
5 keypad keys	enter the new code
6 OK (	assign the new code
7 keypad keys	re-enter the new code
8 OK (	confirm the new code

If You Forget a Code or Password

If you forget your security code (originally set to 000000), SIM PIN, SIM PIN2, or call barring password, contact your service provider.

If you forget your unlock code, try entering 1234 or the last four digits of your phone number. If that does not work, do the following when you see the **Enter Unlock Code** message:

Press	To
1 	go to the unlock code bypass screen
2 keypad keys	enter your security code
3 OK (	submit your security code

Locking and Unlocking the Keypad

You can lock your phone keypad to prevent accidental keypresses (for example, when carrying your phone in a purse or pocket).

Press



To

lock or unlock your keypad

Select  > **More** > **Settings** > **Security** > **Lock Keypad** to view instructions on how to lock/unlock the keypad.

***Note:** Incoming calls and messages unlock the keypad.*

Protecting the SIM Card

Your PIN (Personal Identification Number) code protects the information stored on your SIM card. When the SIM PIN feature is activated, you must enter your SIM card PIN code each time you turn on the phone or insert a SIM card. Your SIM card PIN code is given to you by your service provider.

Find the Feature

 > **More** > **Settings**
> **Security** > **SIM PIN**

Press



To

scroll to **On** or **Off**

2 **SELECT** ()

switch protection on or off

3 keypad keys

enter your SIM card PIN code





4 **OK** ()

submit your code

Unblock the SIM Card PIN Code

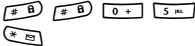



If you enter an incorrect SIM card PIN code three times in a row, your SIM card is disabled and your phone displays **SIM Blocked**. You must enter a PIN unblocking key (PUK) code, which you can obtain from your service provider.

Caution: If the unblocking attempt is tried unsuccessfully 10 times, the SIM card is permanently disabled and your phone displays **SIM Disabled**.

Press	To
1 	open the PIN unblocking editor
2 keypad keys	enter the PUK code
3 OK ()	submit the PUK code
4 keypad keys	enter a new SIM card PIN code
	Note: The SIM PIN code must be between four and eight digits in length.
5 OK ()	assign the new SIM PIN code
6 keypad keys	re-enter the new SIM PIN code
7 OK ()	confirm the new SIM PIN code and unblock the SIM card

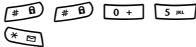
Unblock the SIM Card PIN2 Code

If you enter an incorrect SIM card PIN2 code three times in a row, your phone's SIM PIN2 protected features are disabled and your phone displays **SIM Blocked** when you try to use a PIN2 feature. You must enter a PIN2 unblocking key (PUK2) code, which you can obtain from your service provider.

Press	To
1 	open the PIN2 unblocking editor
2 keypad keys	enter the PUK2 code
3 OK ()	submit the PUK2 code
4 keypad keys	enter a new SIM card PIN2 code
	<i>Note: The SIM PIN2 code must be between four and eight digits in length.</i>
5 OK ()	assign the new SIM PIN2 code
6 keypad keys	re-enter the new SIM PIN2 code
7 OK ()	confirm the new SIM PIN2 code and unblock PIN2 features

Line Security

If your phone displays **Line Not Secure** while you are on a call, your phone has detected another device monitoring the call. This message does not appear when caller ID, call cost, or other information fills the display.

Personal Organiser Features

Datebook

The datebook is a calendar that lets you schedule and organise events such as appointments and meetings. You can review your schedule of events for the week or by the day, and have the datebook play a reminder alarm for specific events.

Note: You must set the phone's correct time and date in order to use the datebook (see page 45).

To schedule or review events in the datebook:

Find the Feature

 > Office Tools > Datebook

Viewing by the Week

When you open the datebook, your phone displays a calendar for the week. Lines or filled boxes under each day indicate scheduled events.

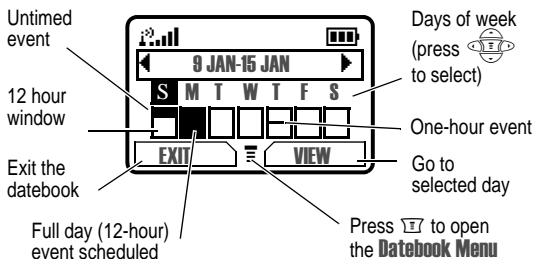

Viewing by the Day

Select a day in the week view and press **VIEW** () to see the day's events. You can store, edit, view, copy, and delete any event from the day view.

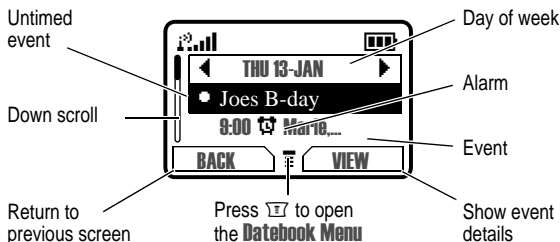

Viewing by the Event

Select an event in the day view and press **VIEW** () to open the detailed event view. You can edit, copy, and delete events from the event view.



Storing a New Event

A title is required for a datebook event. All other information is optional.

Find the Feature

 > **Office Tools** > **Datebook**
> *day*
 > **New**

Press

To

1 **CHANGE** ()

select **Title**

2 keypad keys

enter a title for the event (see page 36)

3 **OK** ()

store the event title

4 

scroll to other fields and enter information as necessary

Other fields let you enter start time, duration, date, repeating events, and reminder alarm.

5 **DONE** ()

store the new event and return to the day view

Changing Event Information

To change information about an existing event:

Find the Feature

 > **Office Tools** > **Datebook**

Press

To

1 





scroll to the scheduled event day

2 **VIEW** ()

display the day view

3 

scroll to the event to change







Press	To
4 VIEW ()	display the event view
5 EDIT ()	edit the event
6 	scroll to the detail to change
7 CHANGE ()	edit the information
8 keypad keys	enter the new information
9 DONE ()	store the information and return to the day view





Copying an Event

To copy information from a current event to a new event:

Find the Feature

 > **Office Tools** > **Datebook**









Press	To
1 	scroll to the scheduled event day
2 VIEW ()	display the day view
3 	scroll to the event to copy
4 	open the Datebook Menu
5 	scroll to Copy
6 SELECT ()	copy the event
7 YES ()	confirm the copy Your phone assumes that you want to change the date, and displays the Date field.
8 keypad keys	enter the date information

Press	To
9  ()	move to the day, month, and year
10 DONE ()	save the copy of the event
11 	scroll to event details and edit the information as necessary
12 DONE ()	store the new event and return to the day view

Deleting an Event

Find the Feature

 > **Office Tools** > **Datebook**

Press	To
1 	scroll to the scheduled event day
2 VIEW ()	display the day view
3 	scroll to the event to delete
4 	open the Datebook Menu
5 	scroll to Delete
6 SELECT ()	select Delete
	For non-repeating events, the procedure is complete. For repeating events, the phone displays a delete event menu:
a 	scroll to This Event Only or Repeat Events
b SELECT ()	select the event(s) to delete

Alarm Reminders

Reminders are alerts that ring or vibrate to notify you about a voicemail or text message you have received, or a datebook event you have scheduled. To set or turn off reminders:

Find the Feature

 > **Ring Styles**
> **Alert Detail** > **Reminders**

Press

1 

To

scroll to the reminder alert you want: **Beep**, **Vibrate**, or **Off**

Beep or **Vibrate** sets the corresponding reminder alert type. **Off** turns off all reminders.

2 **SELECT** ()

select the reminder alert

Calculator

You can use your phone as a convenient calculator and currency converter.

Calculating Numbers

Find the Feature

 > **Office Tools** > **Calculator**

Press

1 number keys

To

enter a number in the calculator

2  (left or right)

highlight a calculator function

3 **SELECT** ()

perform the highlighted function

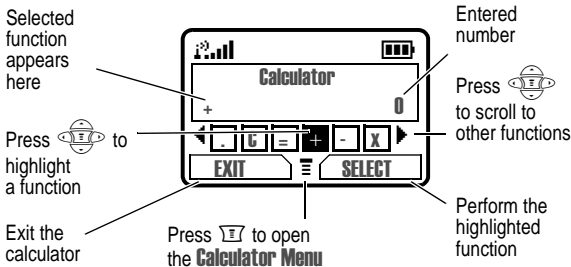

The calculator can perform the following functions:

Function	Description
.	Insert a decimal point
C	Clear the calculation
CE	Clear entry (replaces the C function when you enter more values in a calculation)
+	Add
-	Subtract
x	Multiply
÷	Divide
%	Divide the displayed value by 100
€	Calculate the exchange rate
+/-	Change the entry's sign (positive/negative)
MR	Recall the value stored in memory
MS	Store the displayed number in memory
MC	Clear memory

Converting Currency

The currency converter works just like the calculator, using the € (currency) function and the exchange rate you set:

Find the Feature

 > Office Tools > Calculator

 > Exchange Rate

Press

To

1 number keys

enter the exchange rate

2 **OK** ()

store the exchange rate

3 number keys

enter the amount to convert
(amount to multiply by the
exchange rate)

4  (left or right)

highlight the € function

5 **SELECT** ()

perform the conversion

News and Entertainment

Mobile Internet



The Web micro-browser lets you access Web pages and Web-based applications (such as on-line banking, shopping, and games) on your phone. Contact your service provider to set up access, if necessary.

Note: Your phone may use a high-speed GPRS (General Packet Radio Service) network connection. This type of connection can be identified by a GPRS indicator (Ⓜ) in the idle display that disappears when you start a micro-browser session. If a [] (connected call) indicator is displayed when you start a micro-browser session, your phone is using a standard voice channel connection. Your network connection charges may vary depending on the type of connection used.

Setting Up Your Phone for Mobile Internet Access

Note: Your service provider may have set up your phone for Internet access.

You can adjust the mobile Internet network connection settings, or create a new network connection profile:

Find the Feature

☰ > More > Web Sessions
> [New Entry]

Starting a Mobile Internet Session

To open the Web micro-browser:

Find the Feature

☰ > Browser

The micro-browser displays the home page set up by your service provider.

Press

1



To

scroll to a bookmark or service, or application

2 **SELECT** ()



select the service

Shortcut: If you open a text message with a Web address (URL) in it, you can press  > **Go To** to launch the micro-browser and go directly to the URL.

If you are unable to establish a network connection with the micro-browser, contact your service provider.

Interacting With Web Pages

You can perform the following operations on a Web page:

Do This	To
Press  up or down	scroll through a page
Press  left or right	go back to the previous page or forward to the next one
Press 	open the Browser Menu

Downloading Pictures and Sounds

You can download a file such as a ring tone, wallpaper, screensaver, MotoMixer file, or theme to your phone. To download files with the browser on a desktop computer or your phone:

Do This

- 1 In the browser, go to the Web site and find the file you want.

- 2 Follow the directions on the site to purchase the file (payment details vary). The site sends a text message to your phone, containing the attached file or a URL link to the file.

- 3 Open the message and store the file (see page 75).

Notes:

- *Call charges apply during download sessions.*
- *When your phone runs out of memory for downloaded files, new files overwrite the old ones. Downloaded files share your phone's memory, so you can make room for a picture, for example, by deleting ring tones.*

Phone Themes

A *phone theme* consists of a bundled set of image and sound files with a specific theme (such as a special event or cartoon character) that you can apply collectively to your phone. Phone themes typically include a wallpaper image, screen saver image, and ring tone. Your phone includes several preloaded themes. You can download and install additional themes on your phone.

Downloading Themes

To download a theme from the browser, see page 122. When you install the theme, you can instantly apply its screen saver, wallpaper, and ring tone when your phone prompts you to **Apply theme now?**

Selecting Themes

You can apply any of the themes installed on your phone.

Note: If one of a theme's components is not available, then a default setting is applied.

Find the Feature

 > **Media Centre** > **Theme**

Press

1 

To

scroll to the theme that you would like to apply

2 **SELECT** ()

select the theme

Deleting Themes



You cannot delete the preloaded themes on your phone. To delete one or all of the themes that you have downloaded and installed:

Find the Feature

 > **Media Centre** > **Theme**

Press

1 

To

scroll to the theme to delete

2 **SELECT** ()

select the theme

3 

enter the **Theme** submenu

4 

scroll to **Delete** or **Delete All**

5 **SELECT** ()

select the option

Picture Viewer



Your phone contains pictures and animations that you can insert into text messages, and use as wallpaper and screen saver images.

To download pictures or animations, see page 122. Your phone may also include predefined images that are identified by a ★ (predefined object) indicator. You cannot rename, delete, or view details about predefined images.

Find the Feature

 > **Media Centre**
> **Picture Viewer**

Press

1 

To

scroll to the picture

2 **SELECT** ()

view the picture

3  up or down

view the previous/next picture

or

DETAILS ()

view picture information

or



open the **Picture Viewer** menu to perform other procedures as described in the following list

The **Picture Viewer** menu can include the following options:

Option	Description
Details	View picture information.
Set as Wallpaper	Set the picture as your phone's wallpaper image.

Option	Description
Set as Screen Saver	Set the picture as your phone's screen saver image.
Rename	Rename the picture.
Delete	Delete the picture.

Games

Your phone comes with three games. If you get an incoming call, message, alarm, or alert while playing a game, the game pauses.





In some cases, when the game is over, you may have the option to purchase more advanced game levels.

Selecting and Starting a New Game

Find the Feature

 > **Games** > *the game*

When the game is over, you can play again or return to the games menu. Depending on the game:

Press	To
BACK ( or NO (	return to the games menu
NEW ( or YES (	start another session of the game you just played

Ending a Game

You can end a game at any time.

Press

BACK 

or



To

end the game session and
return to the games menu

Playing a Game

Astrosmash





In Astrosmash, your job as Commander is to repel an attack of meteors and spinning bombs. You try to shoot as many meteors, bombs, missiles, and flying saucers as possible without getting hit.

Item	Points	Item	Points
Big Rock	10	Guided Missile	50
Small Rock	20	Small Spinner	80
Big Spinner	40	UFO	100

Rules of the game

- Guided Missiles move toward the Laser Gun.
- UFOs appear when the score is greater than or equal to 5,000. UFOs sweep across the screen and release bombs at the Laser Gun. The bombs cannot be destroyed
- When you shoot a Big Rock, it breaks into 2 Small Rocks.
- When you are out of Laser Guns, the game is over. You lose a Laser Gun if a spinner (both big and small) hits the ground, or if a rock, rock pieces, or a guided missile collides with a Laser Gun.
- Every time the peak score goes up by another 1,000 points, you get another Laser Gun.

How to Play

Press	To
	move the Laser Gun
	move the Laser Gun to a random position
	toggle control for firing between you and the phone (Auto-Fire)
	fire the Laser Gun, if Auto-Fire is off

MotoGP

In this game, you are a MotoGP motorcycle racer. Before the game begins, you have the option to select a rider, a team, and a track.

How to Play

Press	To
	accelerate, brake, and turn your motorcycle

Snood 21

In this solitaire game, you try to use all the cards in a deck by making combinations of 21 on any of four columns. When a combination of 21 is created, the cards are discarded, letting you start another combination of 21.





If you finish the first level in one minute, you can move on to the next level.

Rules of the game

- Aces are worth either 1 or 11, Jacks, Queens, and Kings are worth 10, and all other cards are worth the amount written on their faces.
- You can place a wild card in any non-frozen column for an automatic 21.

- When the countdown timer reaches 20 seconds, the word **HURRY** blinks twice in place of the cards left field. If the timer reaches zero and there is a card still on the deck, **OUT OF TIME** appears in place of the cards left field for 2 seconds and the game is over.
- The number of cards in a deck depends on the current level: the first level contains 32 cards (two complete suits plus six wild cards), the second level contains 45 cards (three complete suits plus six wild cards), the third and fourth levels contain 58 cards (all four complete suits plus six wild cards)
- When there are no more cards in the deck, you score 200 times the number of cards left in all the columns.
- Every time you place a card, you score 50 points.
- Whenever the total of all the cards placed on a column is equal to 21, you score 100 times the column's position (21 on the first column scores 100 points, while 21 on the third column scores 300). 5 cards totalling less than 21 in a column is treated as 21.
- If the value of the cards in a column is greater than 21, the column is frozen and marked with an **X** (the column's total displays **BUST**).
- If all the columns become frozen, **NO MORE MOVES** appears in place of the cards left field for 2 seconds, and the game is over.

How to Play

Press	To
	place a card on the first column
	place a card on the second column
	place a card on the third column
	place a card on the fourth column

MotoMixer Sound Editor

The MotoMixer lets you edit and save special MIDI-based sound files called *Groove Tunes* on your phone. These sound files are made up of four instrument parts such as *piano, bass, drums, and guitar*. The phone comes preloaded with five base tracks (which cannot be edited or deleted), but you can download others and use them all to create or edit your own MIDI files.

Create or Edit a Mix File









To create or edit a MotoMixer file:

Find the Feature

 > **Media Centre**
> **MotoMixer** > **[New Mix]** or
a tune to edit

Press

To

- | | | |
|----|---|--|
| 1 |  | scroll to a track you want to include in the new mix |
| 2 | SELECT () | select the first base track |
| 3 | CHANGE () | select Name |
| 4 | keypad keys | enter a name for the mix file you are creating (see page 36) |
| 5 | OK () | store the name |
| 6 | CHANGE () | select Tempo |
| 7 |  left or right | adjust the tempo setting |
| 8 | OK () | store the tempo setting |
| 9 | CHANGE () | select Mix and open the base track editor |
| 10 | PLAY () | start playing/mixing the track |
| 11 | keypad keys | edit the base tracks (see following section) |

Press

12 STOP ()

To

stop playing/mixing the track

13 BACK ()

close the base track editor

14 DONE ()





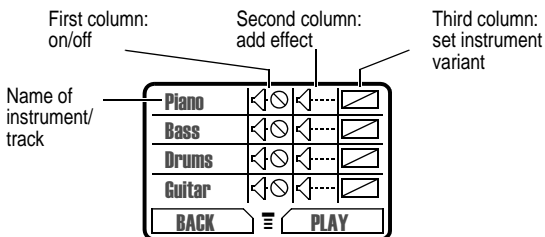

close the mix file display







Base Track Editing Display and Keys

You can select the instruments you want to play and when you want to play them.





Press **PLAY** () to play the mix file. Turn instruments on or off, add effects, and/or set an instrument variant using the following keypad keys.

Key	Effect
	Turn first track (Piano in example) on/off
	Add effect to first track
	Set instrument variant for first track
	Turn second track (Bass in example) on/off
	Add effect to second track
	Set instrument variant for second track

Key	Effect
	Turn third track (Drums in example) on/off
	Add effect to third track
	Set instrument variant for third track
	Turn fourth track (Guitar in example) on/off
	Add effect to fourth track
	Set instrument variant for fourth track

The track plays one time and then stops. Press **PLAY** () again to continue mixing the track. Use the following keys to perform additional mix functions:

	Open a sub-menu to reset one or all tracks
BACK ()	Return to the Mix Details menu when you are finished mixing the track

Note: To download new MotoMixer files, see page 122.

Use, Edit, or Delete a Mix File

To edit or delete a mix file, or set a mix file as a ring tone:

Find the Feature

 > **Media Centre**
> **MotoMixer**

Press

To

1  scroll to the file you want

2  open the mix menu

3  scroll to **Edit, Delete, Play, or Set as Ring Tone**

4 **SELECT** () select the option

Creating Alert Tones

You can create and store custom ring tones on your phone. The ring tones appear in the list of available alerts (see page 46).

Create a Tone

Find the Feature

 > **Media Centre**
> **My Tones** > **[New Tone]**

Press

To

1 **CHANGE** ()

select **Notes**

2 keypad keys

enter notes (see following section)

3 **OK** ()

store the notes

4 **CHANGE** ()

select **Name**

5 keypad keys

enter the name for the tone

6 **OK** ()

store the name

7 **DONE** ()

store the tone

Enter Notes

To create a new ring tone, use the keypad keys to enter notes. For each note, you must specify the octave (optional), pitch, length, and a length modifier (optional). Press a key multiple times to cycle through its available options. Enter the necessary character as described in the following lists.

Octave

The default setting for a new tone is octave four.



Key	Display	Description
	*	enter * followed by a number (0 to 8) to set the octave

Notes and Rests

Key	Display	Description
	#	sharp
	&	flat
	a	note A
	b	note B
	c	note C
	d	note D
	e	note E
	f	note F
	g	note G
	r	rest

Lengths and Modifiers

Key	Display	Description
	0	whole note
	1	half note
	2	quarter note
	3	eighth note
	4	sixteenth note

Key	Display	Description
	5	1/32 note
	.	dotted note
	:	double dotted note
	;	2/3 length note

Note Entry Sequence



























Do This	Action
1 Set the octave (optional)	Set the octave (*0 to *8) <i>before</i> selecting the note. The octave applies to the note and all following notes until you change it again.
2 Set the note to a sharp or flat, if necessary	Enter a sharp or flat (# or b) <i>before</i> selecting the note.
3 Select the note (required)	Press a keypad key.
4 Set length (required)	Set the length (0 to 5) <i>after</i> selecting the note. If you do not specify a length, a 2 (quarter note) length is appended to the note.
5 Modify length (optional)	Enter a length modifier (. , : , or ;) <i>after</i> you set the length.

You can perform the following tasks when creating a tone:

Task	Action
Insert a rest	Enter one or more rests (r characters) as needed in the tone sequence. Set the length of the rest (0 to 5) <i>after</i> the rest, just as you would for a note.
Listen to a new tone as you compose it	Press  to enter the Compose Menu , and select Play All to play the notes you have entered.

Example

Press the following keys to create this sequence of notes and rests in octave three: **C** (quarter note), **E flat** (quarter note), **half rest**, and **G** (whole note):

Press	To	Display
1      	set octave three	*3
2   	enter note C	c
3    	set length to quarter note	2
4    	enter flat symbol	b
5  	enter note E flat	e
6    	set length to quarter note	2
7 	enter rest	r
8 	set length to half rest	1
9 	enter note G	g
10 	set length to whole note	0

Play a Tone

Find the Feature

 > **Media Centre**
> **My Tones**

Press

1 

To

scroll to the tone

2 

open the **Tone Menu**

3 

scroll to **Play**

4 **SELECT** ()

select **Play**

5 **PLAY** ()

play the tone again

or

CANCEL ()

return to the my tones list

Edit a Tone

You cannot edit the predefined ring tones included with your phone. To edit a custom ring tone:

Find the Feature

 > **Media Centre**
> **My Tones**

Press

1 

To

scroll to the tone

2 **EDIT** ()

open the tone details

3 

scroll to the details you want to edit (**Name** or **Notes**)

4 **CHANGE** ()

select the item

5 keypad keys

enter new text or notes

6 **OK** ()

store the new text or notes

7 **DONE** ()

save your changes

Delete a Tone

You cannot delete the predefined ring tones included with your phone. To delete a custom ring tone:

Find the Feature

 > **Media Centre**

> **My Tones**

Press

1 

To

scroll to the tone

2 

open the **Tone Menu**

3 

scroll to **Delete**

4 **SELECT** ()

select **Delete**

SIM Applications



You can access information and applications stored on your SIM card.

To access the available applications:







Find the Feature

 > **More** > **SIM Applications**

Your SIM card may contain applications that process your outgoing calls, text messages, and other events. Contact your service provider for more information.

Troubleshooting

Check these questions first if you have problems with your phone:

Question	Answer
Is your battery charged? Do you see  in the display?	The battery level indicator should have at least one segment showing (). If it does not, recharge your battery. (See page 19 and page 20.)
Do you have a valid SIM card inserted in your phone?	If necessary, turn off your phone and make sure that you have inserted a valid SIM card. (See page 21). If you have problems with your SIM card, contact your service provider.
Does the handset have a signal? Do you see  in the display?	The signal strength indicator should have at least one segment showing (). If it does not, move to an area with a stronger signal to use your phone.
Is the earpiece volume too low?	While on a call, press  to the right to raise the earpiece volume.
Is the other party unable to hear you?	Your phone may be muted. Press UNMUTE () if necessary to unmute the phone. Also, make sure that your phone's microphone is not blocked by its carrying case or a sticker.

Question	Answer
Has the phone been damaged, dropped, or got wet?	Dropping your phone, getting it wet, or using a non-Motorola battery charger can damage the phone. The phone's limited warranty does not cover liquid damage or damage caused from using non-Motorola accessories.
Was a non-Motorola battery charger used?	



The following refer to specific problems:

Problem	Solution
My phone was stolen. To whom should I report this?	Report a stolen phone to the police and to your service provider (the company that sends you your monthly wireless service bill).
I forgot my password.	See page 108.
I pressed the End/Power key, but nothing happened.	Be sure to press and hold  (the End/Power key) until the display appears and you hear an audible alert (this could take a couple of seconds). If nothing happens, check that the battery is charged. (See page 19.)
I pressed keys, but the display has stopped responding.	You might need to reset your phone. See page 26.

Problem	Solution
<p>The display says: Insert SIM Card or Check SIM Card even though I have inserted my SIM card in the phone.</p>	<p>The SIM card may be incorrectly inserted. Check the SIM card to make sure that it is inserted properly. See page 21.</p> <p><i>Note: Be sure to turn your phone off and then back on after you re-insert the SIM card.</i></p> <p>Also, you may have an older SIM card that is not compatible with your phone. Call your service provider for more information.</p>
<p>The display says: SIM Blocked. How do I unblock my SIM card?</p>	<p>Call your service provider (the company that sends you your monthly wireless service bill) to obtain the PIN unblocking key (PUK) code. See page 109.</p>
<p>The display says: Enter Unlock Code. How do I unlock my phone?</p>	<p>Enter the factory-preset unlock code (1234), or the last four digits of your phone number. (See page 106.) If this fails, call your service provider (the company that sends you your monthly wireless service bill).</p>
<p>My phone asks for an unlock code when I try to open a feature.</p>	<p>The application you want is locked. If you own the phone but do not know the unlock code, see page 108.</p>

Problem	Solution
<p>My phone does not ring.</p>	<p>If you see  or  in the display, then the ring tone is turned off. See page 46.</p> <p>Also, the ring tone may be set to Silent even though your phone is set to a ring alert profile. Be sure to listen to your ring tone before setting it to make sure it is effective in the environment where you use your phone.</p>
<p>My phone rings even though I selected the Silent (or Vibrate) alert profile.</p>	<p>The ring tone may be set to play a tone even though your phone is set to a silent alert profile. See page 47.</p>
<p>I tried to place a call and heard an alternating high/low tone.</p>	<p>Your call did not reach the wireless system. You may have dialed the number too soon after turning the phone on. Wait until the display shows the name of your service provider before making a call.</p>
<p>I cannot make/answer calls.</p>	<p>Make sure that you have a phone signal (see page 31). Avoid electrical or radio interference, and obstructions such as bridges, car parks, or tall buildings.</p> <p>Your phone also may have the Call Barring feature turned on. If you know the unlock code, you can change this setting in the security menu ( > More > Settings > Security). Also, check to be sure your SIM card is installed and working.</p>

Problem	Solution
My phone has poor reception and drops calls.	Make sure you have a phone signal (see page 31). Stay clear of any obstructions such as bridges, car parks, or tall buildings.
I cannot hear others on my phone.	While on a call, press the volume key on the left side of your phone. Your phone display should show the volume increasing. Also, make sure that your phone's earpiece is not blocked by its carrying case.
I cannot open my inbox.	Before you can use text or information services messages, you must set up the appropriate inbox. See page 69.
How do I see the calls I sent or received?	To see the most recent calls you dialed or received, open the "Recent Calls" lists:  > Recent Calls > Received Calls or Dialed Calls

Problem	Solution
<p>My phone will not dial voicemail commands, passwords, or other codes.</p>	<p>Your phone sends commands and passwords as DTMF tones. You can set your phone's DTMF tones to be Long, Short, or Off. If you have trouble sending numbers, check your DTMF setting.</p> <p>From the idle display, press:</p> <p style="text-align: center;">  > More > Settings > Other Settings > Initial Setup > DTMF </p> <p>Press  to scroll to Long or Short.</p> <p>Press SELECT () to select it.</p>
<p>My phone's display is too light.</p>	<p>You can change the level of contrast in your phone display. See page 48.</p> <p>You can also change the backlight settings. See page 48.</p>
<p>What can I do to extend battery life?</p>	<p>Your battery's performance is affected by charge time, feature use, temperature changes, and other factors. For tips on extending your battery life, see page 20.</p>
<p>I can't find a file I downloaded.</p>	<p>You may have deleted the file to make room for a new one. See page 122.</p>

Problem	Solution
<p>I plugged the data cable into my phone but my phone did not beep. How do I know if the data cable is ready to go?</p>	<p>The beep indicates that you are set up correctly. If you did not hear a beep, make sure that both ends of the data cable are connected—the smaller end to your phone and the larger end to your computer.</p> <p>Finally, your computer may have deactivated the port to save power. Try opening an application that uses the port, like a fax or dial-up application, and your computer will automatically activate the port.</p>
<p>My phone beeped when I attached the data cable, but my fax and data applications don't work.</p>	<p>Some wireless networks may not support data or fax transmission. If you are roaming on an unfamiliar network, this may be the case.</p> <p>Also, remember that data and fax transmission usually requires a subscription. Call your service provider for more information.</p>
<p>When sending data with the data cable, why does the computer show a connection rate of 19200 Kbps?</p>	<p>19200 Kbps is the data transfer rate of the connection between your computer and the phone in a standard CSD (Circuit Switch Data) connection. The rate of the connection between your phone and the network is displayed on your phone, and will be either 14400 or 9600 Kbps.</p> <p>A GPRS connection may have a higher data transfer rate.</p>

Problem	Solution
<p>I can't end my data call by closing the application on my computer. What can I do?</p>	<p>Try pressing  on your phone. Also try disconnecting the cable or turning off the phone. If possible, always close the connection through your computer. These alternative methods may disrupt the application on your computer.</p>
<p>I launched the micro-browser but the display says: Service Not Available.</p>	<p>You may be in an area without service, or you may be connected to a network that does not support Internet access.</p>
<p>I launched the micro-browser but the display says: Data Server Unavailable.</p>	<p>Try again in a few minutes. The servers may be temporarily busy.</p>

Warranty Information

Motorola guarantees you, the original purchaser, the Personal Communicator and accessories which you have purchased from an authorised Motorola dealer (the "Products"), to be in conformance with the applicable Motorola specifications current at the time of manufacture for a term of [1] year from date of purchase of the Product(s) (WarrantyTerm).

You must inform Motorola of the lack of conformity to the applicable specifications of any of the Products within a period of two (2) months from the date on which you detect a defect in material, workmanship or lack of conformity and in any event within a term not to exceed the Warranty Term, by submitting the Product for service to Motorola. Motorola shall not be bound by Product related statements not directly made by Motorola nor any warranty obligations applicable to the seller.

A list of the Motorola Call Centre numbers is enclosed with this Product.

During the Warranty term, Motorola will, at its discretion and without extra charge, as your exclusive remedy, repair or replace your Product which does not comply with this warranty; or failing this, to reimburse the price of the Product but reduced to take into account the use you have had of the Product since it was delivered. This warranty will expire at the end of the Warranty Term.

This is the complete and exclusive warranty for a Motorola Personal Communicator and accessories and in lieu of all other warranties, terms and conditions, whether express or implied.

Where you purchase the product other than as a consumer, Motorola disclaims all other warranties, terms and conditions express or implied, such as fitness for purpose and satisfactory quality.

In no event shall Motorola be liable for damages nor loss of data in excess of the purchase price nor for any incidental special or consequential damages* arising out of the use or inability to use the Product, to the full extent such may be disclaimed by law.

This Warranty does not affect any statutory rights that you may have if you are a consumer, such as a warranty of satisfactory quality and fit for the purpose for which products of the same type are normally used under normal use and service, nor any rights against the seller of the Products arising from your purchase and sales contract.

(*including without limitation loss of use, loss of time, loss of data, inconvenience, commercial loss, lost profits or savings.

How to get warranty service?

In most cases the authorised Motorola dealer which sold and/or installed your Motorola Personal Communicator and original accessories will honour a warranty claim and/or provide warranty service. Alternatively, for further information on how to get warranty service please contact either the customer service department of your service provider or Motorola's call centre at the telephone numbers below for your country.

In order to claim the warranty service you must return the Personal Communicator and/or accessories in question to Motorola please avoid leaving any supplementary items like SIM cards. The Product should also be accompanied by a label with your name, address, and telephone number; name of operator and a description of the problem. In the case of vehicular installation, the vehicle in which the Personal Communicator is installed should be driven to the Authorised Repair Centre, as analysis of any problem may require inspection of the entire vehicular installation.

In order to be eligible to receive warranty service, you must present your receipt of purchase or a comparable substitute proof of purchase bearing the date of purchase. The phone should also clearly display the original compatible electronic serial number (IMEI) and mechanic serial number [MSN]. Such information is contained with the Product.

Conditions

This warranty will not apply if the type or serial numbers on the Product has been altered, deleted, duplicated, removed, or made illegible. Motorola reserves the right to refuse free-of-charge warranty service if the requested documentation can not be presented or if the information is incomplete, illegible or incompatible with the factory records.

Repair, at Motorola's option, may include reflashing of software, the replacement of parts or boards with functionally equivalent, reconditioned or new parts or boards. Replaced parts, accessories, batteries, or boards are warranted for the balance of the original warranty time period. The Warranty Term will not be extended. All original accessories, batteries, parts, and Personal Communicator equipment that have been replaced shall become the property of Motorola. Motorola does not warrant the installation, maintenance or service of the products, accessories, batteries or parts.

Motorola will not be responsible in any way for problems or damage caused by any ancillary equipment not furnished by Motorola which is attached to or used in connection with the Products, or for operation of Motorola equipment with any ancillary equipment and all such equipment is expressly excluded from this warranty.

When the Product is used in conjunction with ancillary or peripheral equipment not supplied by Motorola, Motorola does not warrant the operation of the Product/peripheral combination and Motorola will not honour any warranty claim where the Product is used in such a combination and it is determined by Motorola that there is no fault with the Product. Motorola specifically disclaims any responsibility for any damage, whether or not to Motorola equipment, caused in any way by the use of the Personal Communicator, accessories, software applications and peripherals (specific examples include, but are not limited to: batteries, chargers, adapters, and power supplies) when such accessories, software applications and peripherals are not manufactured and supplied by Motorola.

What is not covered by the warranty

This warranty is not valid if the defects are due to damage, misuse, tampering, neglect or lack of care and in case of alterations or repair carried out by unauthorised persons.

1. Defects or damage resulting from use of the Product in other than its normal and customary manner.
2. Defects or damage from misuse, access to incompatible sources, accident or neglect.
3. Defects or damage from improper testing, operation, maintenance, installation, adjustment, unauthorised software applications or any alteration or modification of any kind.
4. Breakage or damage to antennas unless caused directly by defects in material or workmanship.
5. Products disassembled or repaired in such a manner as to adversely affect performance or prevent adequate inspection and testing to verify any warranty claim.
6. Defects or damage due to range, coverage, availability, grade of service, or operation of the cellular system by the cellular operator.
7. Defects or damage due to moist, liquid or spills of food.
8. Control unit coil cords in the Product that are stretched or have the modular tab broken.
9. All plastic surfaces and all other externally exposed parts that are scratched or damaged due to customer normal use.
10. Leather cases (which are covered under separate manufacturer's warranties).
11. Products rented on a temporary basis.
12. Periodic maintenance and repair or replacement of parts due to normal wear and tear.

Note: *The talk-time, stand-by time and total life cycle of a Motorola rechargeable battery for your Personal Communicator will depend on usage conditions and network configurations. As a consumable product, the specifications indicate that you should be able to obtain optimum performance for your Motorola Personal Communicator within the first six months from date of purchase and up-to (200) charges.*

The warranty for Motorola rechargeable batteries becomes void if (i) the batteries are charged other than by Motorola approved battery chargers specified for the charging of the battery, (ii) any of the seals on the battery are broken or show evidence of tampering, (iii) the battery is used in equipment or service other than the cellular telephone equipment for which it is specified.

Specific Absorption Rate Data

This model phone meets international standards for exposure to radio waves

Your mobile phone is a radio transmitter and receiver. It is designed and manufactured not to exceed limits for exposure to radio frequency (RF) energy. These limits are part of comprehensive guidelines and establish permitted levels of RF energy for the general population. The guidelines are based on standards that were developed by independent scientific organisations through periodic and thorough evaluation of scientific studies. The guidelines include a substantial safety margin designed to assure the safety of all persons, regardless of age and health.

The exposure standard for mobile phones employs a unit of measurement known as the Specific Absorption Rate, or SAR. Under the guidelines for your phone model, the SAR limit is 2.0 W/kg.* Tests for SAR are conducted in accordance with CENELEC** testing procedures using standard operating positions with the phone transmitting at its highest certified power level in all tested frequency bands. Although the SAR is determined at the highest certified power level, the actual SAR of the phone while operating can be well below the maximum value. This is because the phone is designed to operate at multiple power levels so as to use only the power required to reach the network. In general, the closer you are to a base station, the lower the power output of the phone.

Before a phone model is available for sale to the public, it is tested to confirm compliance with the guidelines. The tests are performed in positions and locations (e.g., at the ear and worn on the body) that conform to a uniform testing methodology determined by an expert standards body. The highest SAR value for this model phone when tested for use at the ear is: 0.9 W/kg.***

While there may be differences between the SAR levels of various phones and at various positions, they all meet the governmental requirements for safe exposure. Please note that modifications to this product model could cause differences in the SAR value for later products; in all cases, products are designed to be within the guidelines.

-
- * The SAR limit recommended by international guidelines (ICNIRP) for mobile phones used by the public is 2.0 watts/kilogram (W/kg) averaged over ten grams of tissue. The limit incorporates a substantial margin for safety to give additional protection for the public and to account for any variations in measurements.
 - ** CENELEC is a European Union standards body.
 - *** Additional related information includes the Motorola testing protocol, assessment procedure, and measurement uncertainty range for this product.

Index

A

accessories

- connector ports 1
- optional 17, 50, 101
- standard 17

Add Digits feature 57

alert

- creating 132
- defined 46
- indicators 32, 46
- reminders 117
- type, selecting 47

alert profile 47

animation 49, 122

- managing 124–125
- screen saver 125
- wallpaper 95, 124

appointments. *See* datebook

Astrosmash 126

Attach Number feature 57, 59

B

backlight 48

barring calls 67–68

battery

- charging 19

- extending battery life 20, 48, 49, 143

- installing 18

- level indicator 20, 30, 32

block cursor, defined 36

browse text mode 37

browser. *See* micro-browser

C

calculator 117–119

calendar. *See* datebook

call

- adding digits after phone number 57

- alert profile, setting 47

- alert type, selecting 47

- alert, creating 132

- answering 28

- barring 67–68

- call waiting 62–63

- cancelling 53

- costs 100

- deleting 55

- dialled calls list 55

- dialling 27–28

- dialling a recent call 55

- emergency number 54

- ending 28

- hold 68
 - ignoring 53
 - making 27–28
 - placing 27–28
 - prefix digits, inserting 59
 - received calls list 55
 - receiving 28
 - recent calls 55
 - storing 55
 - terminating 53
 - timing 98, 98–99
 - transferring 66–67
 - unanswered call 58
 - call barring 67–68
 - call cost information 100
 - call diverting 63–65
 - call timers 98, 98–99
 - call waiting 62
 - caller ID
 - incoming calls 53
 - outgoing calls 57
 - calling line identification. *See* caller ID
 - car kit
 - automatic answer 50
 - automatic hands-free 51
 - chat 75–78
 - clock 30
 - codes. *See* passwords
 - colour, display 48
 - computer
 - connecting to phone 102–103
 - conference call 65–66
 - contrast, display 48
 - cost trackers 100
 - credit information 100
 - currency converter 119
 - cursor 36
 - customer service, calling 62
- ## D
- data call
 - connecting to external device 102–103
 - receiving 103–104
 - sending 103
 - date, setting 45
 - datebook
 - adding an event 114
 - alarm 114
 - calendar 112
 - changing event information 114–115
 - copying an event 115–116
 - day view 113
 - deleting an event 116
 - event view 113
 - reminders 114, 117
 - week view 112
 - Datebook Menu** 112, 113
 - default passwords 107

- deleting a call 55
- dialled calls list 55
- dialling
 - service numbers 97
- dialling a number 27–28
- display
 - animation 49
 - backlight 48
 - colour 48
 - contrast 48
 - described 30
 - frozen 26
 - greeting 46
 - idle display 30
 - illustration 30
 - language 93
 - resetting 26
 - zoom setting 45
- diverting calls 63–65
- download
 - animation 75, 122
 - ring tone 75, 122
 - screen saver 75, 122
 - theme 122
- DTMF tones 56, 57, 98, 143

E

- earpiece
 - illustration 1
 - volume, adjusting 27

- email address, storing in
 - phonebook 80
- emergency number 54
- end key
 - functions 1, 28, 33
- ending a call 28
- Enter Unlock Code** message 107, 108
- Entry Method** menu 41
- event alert 47
- exchange rate, calculating 119
- external device
 - connecting to phone 102–103

F

- factory settings, resetting 49–50
- fax call
 - connecting to external device 101
 - receiving 103
 - sending 103
- fixed dial
 - defined 96
 - dialling numbers 96
 - editing an entry 85–86, 96
 - storing an entry 80–83
- flashing cursor, defined 36
- frequency, changing 105

G

- games 125–128
- GPRS indicator 30, 31
 - displayed 120
- GPRS, defined 120
- greeting, display 46

H

- hands-free mode
 - automatic answer 50
 - automatic call routing 51
 - defined 50
- headset
 - automatic answer 50
- Hide ID** feature 57
- hold a call 68

I

- icon ID 82, 83
- icon ID, setting 83
- idle display, defined 30
- ignoring a call 53
- inbox, text message 69–70
- incoming call
 - cancelling 53
 - ignoring 53
 - terminating 53
- Incoming Call** message 53
- indicators
 - alert setting 32, 46

- battery level 20, 30, 32
- GPRS 30, 31, 120
- menu 30, 32
- message 31
- message waiting 30, 73
- missed call 58
- ring alert 32, 46
- roam 30, 31
- signal strength 30, 31
- silent alert 32, 46
- text entry 31
- transmit 31
- vibrate alert 32, 46
- voice name 79
- iTAP™ software
 - activating 41
 - described 41
 - entering words 42

K

- key
 - end 1, 28, 33
 - left soft key 1, 33, 92
 - lock 109
 - menu 1, 33, 52
 - navigation 1
 - right soft key 1, 33, 92
 - send 1, 28, 55
 - voice 84
 - volume control 27
- keypad

locking and unlocking 109
volume, setting 47

L

language, setting 93

Last Calls Menu

opening 56
options 57

left soft key

customising 92
functions 1, 33

lock

keypad 109
phone 106–107
SIM card 109

loud ring alert 32, 46

M

making a call 27–28

master clear 50

master reset 49

Memory is Full! message 76

menu

Browser Menu 121

Datebook Menu 112, 113

entering text 35–36, 45

Entry Method menu 41

features 96

language, setting 93

Last Calls Menu 56

lists 34

MyMenu 93

navigating 34

Phonebook Menu 79

scroll feature 48

Text Msg Menu 74–75

using features 35–36

menu indicator

defined 30, 32

illustration 30

menu key 1, 33, 52

message

chat 75–78

deleting, text 73–75

dialling number from 97

inbox setup 69–70

locking, text 73–75

outbox 72

reading, text 73–75

receiving, text 73

reminders, receiving 73

reminders, text message

117

reminders, voicemail 60,

117

sending 71

status 72

voicemail 59–61

message indicator

defined 31

message waiting indicator

displayed 73

- flashing 73
- illustration 30
- micro-browser
 - animation 122
 - Browser Menu** 121
 - defined 120
 - functions 121
 - go back to previous page 121
 - picture 122
 - sound 122
 - starting 120, 121
- microphone 1
- missed call indicator 58
- Missed Calls** message 58
- moto GP 127
- My Menu
 - creating 94
 - using 94
- my telephone number 29, 52
- my tones 132

N

- navigation keys 1
- network settings 105
- notepad
 - defined 58
 - entering digits 58
- number
 - viewing your number 29
- number, viewing your own 52

- numeric text mode 37

O

- 1-touch dial
 - defined 61
 - setting preference 61
 - using 61
- optional accessory, defined 17
- optional feature, defined 17
- outbox 72

P

- passwords
 - changing 107
 - default 107
 - if you forget a password 108
- phone
 - accessories, optional 17
 - accessories, standard 17
 - connecting to external device 102–103
 - credit available 100
 - date, setting 45
 - erase user-entered information 50
 - frequency, changing 105
 - keypad, locking and unlocking 109
 - language, setting 93
 - locking 106–107
 - network settings 105

- 1-touch dial 61
- passwords 107, 108
- reset all options 49
- security code 108
- speed dial, using 61
- startup greeting 46
- text entry indicator 31
- time, setting 45
- unlock code 108
- unlocking 27, 106–107
- phone number
 - adding digits after 57
 - attaching to prefix digits 59
 - attaching two numbers 57
 - redialling 52
 - sending text message to 71
 - storing in phonebook 80–83
 - viewing your number 29
 - viewing your own 52
- phonebook
 - attaching two numbers 57
 - capacity, checking 90
 - copying entries 87–90
 - deleting an entry 86
 - dialling a number 85
 - editing an entry 85–86
 - email address 79
 - entry name 79
 - fields 79
 - icon ID 82, 83
 - number type indicator 79
 - 1-touch dial 61
 - phone number 79
 - prefix digits, inserting 59
 - ringer ID 82, 93
 - sorting entries 86
 - speed dial number 61, 82
 - speed dial, using 61
 - storing an entry 80–83
 - voice name entry 84
 - voice name indicator 79
- Phonebook Menu** 79
- picture
 - managing 124–125
 - screen saver 125
 - storing 122
 - wallpaper 95, 124
- PIN code
 - activating/deactivating 109
 - defined 109
 - protecting the SIM card 109
 - unblocking 110
- PIN2 code 96
 - unblocking 111
- predictive text entry
 - activating 41
 - entering words 42
- profile
 - customising 47
 - setting 47
- PUK code 110
- PUK2 code 111

Q

quick dial 62

R

received calls list 55

receiving a call 28

recent calls 55

redial

 busy number 52

reminders

 chat message 78

 datebook 114

 setting 117

 text message 73, 117

 voicemail message 60, 117

reordering the main menu 91

reordering the Message Centre

 menu 91

resetting display 26

right soft key

 customising 92

 functions 1, 33

ring alert

 creating 132

 indicators 32, 46

 setting 47

 type, selecting 47

 volume, adjusting 27, 47

ring and vibrate alert

 indicator 32, 46

ringer ID

 listed in phonebook entry 80

 setting 82

 turning on/off 93

roam indicator

 defined 31

 illustration 30

S

screen saver 125

scroll feature 48

security code 108

send key 1, 28, 55

sending a call. *See* making a
 call

service dial 97

short message service. *See*
 text message

shortcuts 93

Show ID feature 57

signal strength indicator

 defined 31

 illustration 30

silent alert indicator 32, 46

SIM applications 137

SIM Blocked message 26, 110,
 111

SIM card

 applications 137

 defined 21

 precautions 21

 protecting 109

- service phone numbers 97
- SIM Blocked** message 26, 110, 111
- SIM Disabled** message 110
- unblocking 110
- SIM Disabled** message 110
- SIM PIN code
 - activating/deactivating 109
 - protecting the SIM card 109
 - unblocking 110
- SIM PIN2 code 96
- unblocking 111
- SMS. *See* text message
- snood 21 127
- soft keys
 - customising 92
 - illustration 1, 33
- soft ring alert 32, 46
- sound
 - storing 122
- speed dial
 - changing number 82
 - number, defined 61
 - sorting phonebook entries by 86
 - using 61
- storing a call 55
- symbol text mode 40–41
- symbols, entering 40–41

T

- Talk and Fax call 104
- tap method text entry 37
- telephone number
 - viewing your number 29
- telephone number, viewing your own 52
- text
 - block cursor 36
 - browse mode 37
 - character chart 38
 - entering from keypad 36, 45
 - entry mode, changing 37
 - flashing cursor 36
 - numeric mode 37
 - symbol chart 41
 - symbol mode 40–41
 - tap method 37
- text entry indicator
 - defined 31
- text message
 - deleting 73–75
 - dialling number from 97
 - inbox setup 69–70
 - locking 73–75
 - reading 73–75
 - receiving 73
 - reminders 73, 117
 - sending 71
 - status 72
- text mode, changing 37

- themes 122
- time, setting 45
- timers 98, 98–99
- transfer a call 66–67
- transmit indicator
 - defined 31
- travel charger, using 19

U

- unblocking the SIM card 110
- unlock
 - keypad 109
- unlock code 106–107, 108

V

- vibrate alert
 - indicator 32, 46
 - setting 47
 - type, selecting 47
- voice dial
 - dialling a number 85
 - recording voice name 84
- voice name
 - defined 84
 - phonebook indicator 79
 - recording 84
- voicemail 59–61
- volume
 - earpiece 27
 - keypad 47
 - ring 27, 47

W

- wallpaper 95, 124
- Web pages 120, 121

Z

- zoom setting 45