

Items shown in *Italics* are available only when **Extended Menus** are switched on.

If your service provider has added their own menu, Access Internet will not be the first item in the Options menu.

† Availability depends on the type and settings of the SIM card and/or your subscription to these services.

* The **Accessory Setup** option is available only when a car kit or headset is fitted.

‡ The features and the positions of the features in the Quick Access menu can be changed.









Quick Reference

English

Quick Reference

English

Special Keys

-  Press to turn phone on and off.
-  Press to accept call, setting, option,...
-  Press to reject call, setting, option,...
-  Press to enter the Quick Access features.
-  Press to access the options or phone book menus.
-  Press both simultaneously to lock the keypad; also use to scroll left and right.
-  Press to scroll up and down.
-  Press to call Voicemail.

Making a Call

Enter **Phone No.** .



Receiving a Call

Press .



Ending a Call

Press  or .

Making an Emergency Call

Enter    . The call will be directed to a central emergency operator.



Quick Access Features

Press  followed by the appropriate key, or press , scroll to the feature and press  to select.

Adjust Ringer Volume

Press  followed by the volume button to either increase or decrease the ringer volume.



Redialling the Last Number Called

- 1 Press  to display the last number dialled.
- 2 Press  to call the number.

One-Touch Dialling

Press and hold the appropriate digit key  to .

Storing Numbers in the Phone Book

Press   to store a number on the SIM card.

Dialling Phone Book Numbers

Enter **Location**  .

Stopping a Call Alert

Press the volume button when the phone is ringing. This will stop the alert but not answer the call.

Introduction

Welcome

Congratulations on your purchase of a mobile phone from *Motorola*, the world leader in cellular technology. The phones are packed with features that put you in control and give you unrivalled power, whilst remaining discrete.



Control

- Customisable Quick Access Menu  - Place nine of your most frequently used features in your own personal menu so that they can be accessed with just two key presses. Icons make each feature easy to identify.

Enjoyment and Entertainment

- WAP - Easy keypad Internet access and fast delivery of information.

Power

- Superb battery performance  - Each phone is capable of several hours conversation or several days standby, but is still small and light.
 - Dual Band  - versions of the phone include the powerful dual band feature which means that they can use 900 and 1800MHz bands for greater call success and allow wider roaming opportunities.
-  **Before you use your phone, please see the 'Your Battery' section for important information on charging a new battery.**

Personality™

This cellular telephone incorporates *Personality™*. Unique to *Motorola*, *Personality™* removes the complexity of cellular communications by guiding you through the features and presenting you with simple choices every step of the way. *Personality™* also allows you to personalise the way you use your phone - for example, different ringer tones, a phone book and network selection preferences - all presented with clarity and simplicity. In this manual, each of the *Personality™* features is identified with an  symbol to indicate that it is customisable to meet your requirements.



Understanding this Manual

Many of your phone options are accessed by a simple menu system. A full description of the menus and how to move around them is covered in the next section **Menu Navigation**. When the manual describes the use of each menu item, it will be assumed that you are familiar with the menu system.

Key Presses

Key presses are represented in this manual using symbols so that you may locate and use the required sequence quickly. A sequence of key presses may be shown as follows:

This means that you should press the  key followed by the  key and then the  key, in sequence, not simultaneously.

Entering Information

When you are requested to enter information, such as the number of the phone you wish to call, this is represented in **bold** type. For example:

Phone No. - enter the required telephone number.

PIN Code - enter your Personal Identification Number.

Unlock Code - enter your unlock code.

Location - enter the Phone Book location number.

Prompts and Messages

Your phone responds to key presses by displaying either easy to understand prompts that guide you to the next action, or simple messages confirming that your action is complete. Prompts and messages are represented in this manual in LCD style, for example:

Enter PIN or Completed.

Other Symbols

You will find the following symbols used throughout this manual:

 A Note contains additional information which is relevant to the feature/item.

 A Caution contains important additional information which is relevant to the efficient and/or safe usage of your phone.

 This symbol indicates that the feature is a **Personality**[™] feature that can be customised to meet your requirements.

 This symbol indicates a short key sequence for the feature.

Menu Navigation

A large number of your phone's options are accessed by using menus which use a common approach for selection, change and cancellation.







Please read this section carefully before attempting to access a menu option. When you understand the common approach to menu navigation and how the menus are shown on the page, you will be able to access and change options with ease.

Entering the Menu



Two different keys are used to access the menus:



 enters the Options menu whilst in standby mode; enters the In-call menu during a call.

 enters the Quick Access menu.

Once entered, the menus use the , , , ,  and  keys in a common manner to access, select and change individual options.

Leaving the Menu



To leave any of the menus, you can either press and hold the  key or repeatedly press the  key. Both of these actions will return your phone to the standby mode.

 Alternatively, a quicker way to leave the menus is to press  .

Menus and Sub-menus

A menu is a simple list of options. Some of these options provide access to a further list of options called a sub-menu. When navigating through the menus you may find it helpful to think in terms of menu levels - the 'parent' menu being on one level and its sub-menus being on a lower level.

Moving To and Selecting a Menu Option

To move from one option to another on the same level, use the scroll keys: the  key scrolls forwards and the  key scrolls backwards. When you find the option you want, press the  key to select it.

Depending on the option you select, one of three things will happen:

- either a brief message will be displayed confirming an action, for example *Completed*.
- or a prompt will be displayed requesting you to enter information, for example *Enter PIN* or *Enter Name*.
- or the first option of a sub-menu will be displayed. You can select this option using the  key or browse through the other options using the scroll keys.

To leave an option or sub-menu, press the  key. This will take you back to the parent menu item.

Menu Options with Security Codes

Some options are protected from misuse by requiring you to enter one of the security codes. To use these options, you must enter the requested code before proceeding.

Menu Navigation - A Working Example

The following steps will take you through how to switch the Extended Menu option on:

- 1 When the phone is in the standby mode, press the **MENU** key. This will access the Options menu and Access Internet will be displayed.[#]
- 2 Press the **▼** key repeatedly until the Phone Setup sub-menu item is shown in the display.
- 3 Press the **OK** key to select the sub-menu.
- 4 Press the **▼** key repeatedly until the Extended Menu sub-menu item is shown in the display.
- 5 Press the **OK** key to select this item. You can now select between On or Off, the current setting will be shown with a ✓ character. If the ✓ character is next to Off, press **▼** and then **OK** to switch on the Extended Menu. If the ✓ character is next to On, press **C** to leave the setting as it is.

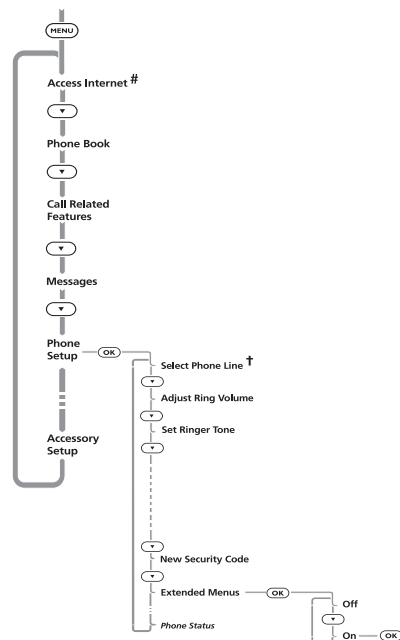

[#] If your service provider has added their own menu, Access Internet will not be the first item in the Options menu.

[†] Availability depends on the type and settings of the SIM card, and/or your subscription to these features.

OK Short, Extended and Personalised Menus

With *Personality*[™] you can personalise the menus by choosing which features you want readily available. The features that are less frequently used can be stored out of sight.

The menu diagrams in this manual show the condition of the menu settings when you first receive your phone. Some features are in the Short Menu and are shown in **bold** type. Other features are in the Extended Menu and appear in *italics*.

You can change which features appear in the Short and Extended Menus, and therefore personalise the menus, to suit your requirements.

If you want to move a feature from the Short Menu to the Extended Menu (or from the Extended Menu to the Short Menu), go to the feature and then hold down the **OK** key until a prompt appears offering the following choices:

- Add the current feature to the Short Menu/Extended Menu.
- Leave the current feature in the Short/Extended Menu.

Select the option you want by pressing the **OK** key.

The settings for some menu features cannot be changed.

Total Customer Satisfaction

At Motorola, Total Customer Satisfaction is a top priority. If you have a question, a suggestion or a concern about your Motorola Cellular Phone, Motorola wants to hear from you.

Please contact the Motorola Cellular Response Centre by fax on: +44 (0) 131 458 6732, or use one of the local phone numbers in the following countries:

Austria	0800 297246	Qatar	418999
Belgium	0800 72 370	Saudi Arabia	01 2303294
Czech Republic	00420 2 21 85 21 01	South Africa	0800 11 48 49
Denmark	4348 8005	Spain	902 100 077
Egypt	02 3411800	Sweden	08 445 1210
Eire	01 402 6887	Switzerland	0800 553 109
Finland	0800 117 036	Turkey	0212 425 9090
France	0 803 303 302	UK	0500 55 55 55
Germany	0180 35050	United Arab Emirates	04 32 11 66
Greece	00800 441 28150	Hong Kong	852 25063888
Italy	02 696 333 16	People's Republic of China	86 10 68466060
Jordan	06 863750	Singapore	65 4855 333
Kuwait	484 2000 Ext 1177	Taiwan	886 2 87731746
Lebanon	01 744156	United States of America	1 800 331 6456
Luxembourg	0800 21 99	Canada	1 800 461 4575
Netherlands	0800 022 27 43		
Norway	22 55 10 04		
Oman	790925		
Portugal	01 318 0051		

For e-mail queries contact:mrcr@ei.css.mot.com
For Internet queries contact:<http://www.mot.com>

Motorola's Warranty

Your Cellular Phone is warranted by Motorola to be of satisfactory quality, fit for its purpose and comply with applicable Motorola specifications for a period of twelve (12) months from the date you bought it (verified by reference to your proof of purchase).

This warranty does not apply if the phone has:

- 1 been mishandled, misused, wilfully damaged, neglected, improperly tested, repaired, altered or defaced in any way.
- 2 a defect arising as a result of any failure to follow instructions either in the manual or product specification.
- 3 a defect which has arisen from the use of non-Motorola approved accessories or ancillary items attached to or in connection with the telephone.

This warranty does not affect your statutory rights as a consumer. Warranty conditions may vary depending on the country in which you bought the phone.



Contents

Safety	
Important information for the efficient and safe operation of your phone.....	11
About Your Phone, Battery and SIM Card	
Introduces your phone, explains how to charge and maintain batteries, explains about your SIM Card.....	15
Making and Receiving Phone Calls	
Explains how to make single or conference calls, how to redial, how to transfer a call, and how to end a call.....	23
Using The Options Menu	
Provides an explanation of the Options Menu and how to use it.....	33
Using the Quick Access Menu	
Provides an explanation of the Quick Access Menu and how to use it.....	73
Accessories	
Details the accessories available for use with your phone.....	77
What To Do If...	
Helps you to solve any problems that may occur.....	79
Index	
A comprehensive Index	83

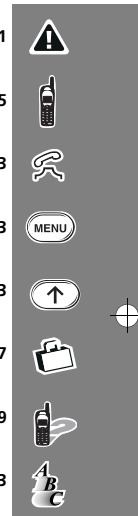



Safety

IMPORTANT

For the efficient and safe operation of your wireless handheld portable telephone, observe these guidelines.

Exposure To Radio Frequency Signals

Your wireless handheld portable telephone is a low power radio transmitter and receiver. When it is ON, it receives and also sends out radio frequency (RF) signals.

European and International agencies have set standards and recommendations for the protection of public exposure to RF electromagnetic energy.

- International Commission on Non-Ionizing Radiation Protection (ICNIRP) 1996
- Verband Deutscher Elektringenieure (VDE) DIN-0848
- Directives of the European Community, Directorate General V in Matters of Radio Frequency Electromagnetic Energy
- National Radiological Protection Board of the United Kingdom, GS 11, 1988
- American National Standards Institute (ANSI) IEEE.C95.1-1992
- National Council on Radiation Protection and Measurements (NCRP). Report 86
- Department of Health and Welfare Canada. Safety Code 6

These standards are based on extensive scientific review. For example, over 120 scientists, engineers and physicians from universities, government health agencies and industry reviewed the available body of research to develop the updated ANSI Standard.

The design of your phone complies with these standards when used normally.

Antenna Care

Use only the supplied or approved replacement antenna. Unauthorised antennas, modifications or attachments could damage the phone and may violate FCC regulations.

Phone Operation

Normal Position: Hold the phone as you would any other telephone with the antenna pointed up and over your shoulder.

Tips on Efficient Operation: For your phone to operate most efficiently:

- Extend your antenna fully (if applicable).
- Do not touch the antenna unnecessarily when the phone is in use. Contact with the antenna affects call quality and may cause the phone to operate at a higher power level than otherwise needed.

Batteries



! All batteries can cause property damage, injury or burns if a conductive material such as jewellery, keys or beaded chains touches exposed terminals. The material may complete an electrical circuit and become quite hot. To protect against such unwanted current drain, exercise care in handling any charged battery, particularly when placing it inside your pocket, purse or other container with metal objects. When the battery is detached from the phone, your batteries are packed with a protective battery cover; please use this cover for storing your batteries when not in use.

Driving

Check the laws and regulations on the use of wireless telephones in the areas where you drive. Always obey them. Also, if using your phone while driving, please:

- give full attention to driving - driving safely is your first responsibility
- use hands-free operation, if available
- pull off the road and park before making or answering a call if driving conditions so require.

Electronic Devices

Most modern electronic equipment is shielded from RF signals. However, certain electronic equipment may not be shielded against the RF signals from your wireless phone.

Pacemakers

The Health Industry Manufacturers Association recommends that a minimum separation of six (6") inches be maintained between a handheld wireless phone and a pacemaker to avoid potential interference with the pacemaker. These recommendations are consistent with the independent research by and recommendations of Wireless Technology Research.

Persons with pacemakers:

- Should **ALWAYS** keep the phone more than six inches from their pacemaker when the phone is turned on.
- Should not carry the phone in a breast pocket.
- Should use the ear opposite the pacemaker to minimise the potential for interference.

If you have any reason to suspect that interference is taking place, turn your phone **OFF** immediately.

Hearing Aids

Some digital wireless phones may interfere with some hearing aids. In the event of such interference you may want to consult your hearing aid manufacturer to discuss alternatives.

Other Medical Devices

If you use any other personal medical device, consult the manufacturer of your device to determine if they are adequately shielded from external RF energy. Your physician may be able to assist you in obtaining this information.

Turn your phone **OFF** in health care facilities when any regulations posted in these areas instruct you to do so. Hospitals or health care facilities may be using equipment that could be sensitive to external RF energy.

Vehicles

RF signals may affect improperly installed or inadequately shielded electronic systems in motor vehicles. Check with the manufacturer or its representative regarding your vehicle. You should also consult the manufacturer of any equipment that has been added to your vehicle.

Posted Facilities

Turn your phone **OFF** in any facility where posted notices so require.

Aircraft

FCC regulations prohibit using your phone while in the air. Switch **OFF** your phone before boarding an aircraft.

Blasting Areas

To avoid interfering with blasting operations, turn your phone **OFF** when in a "blasting area" or in areas posted: "turn off two-way radio". Obey all signs and instructions.

Potentially Explosive Atmospheres

Turn your phone **OFF** and do not remove the battery when in any area with a potentially explosive atmosphere and obey all signs and instructions. Sparks, from your battery, in such areas could cause an explosion or fire resulting in bodily injury or even death.



Areas with a potentially explosive atmosphere are often, but not always clearly marked. They include fueling areas such as gasoline stations; below deck on boats; fuel or chemical transfer or storage facilities; areas where fuel odors are present, i.e. if a gas/propane leak occurs in a car or home; areas where the air contains chemicals or particles, such as grain, dust, or metal powders; and any other area where you would normally be advised to turn off your vehicle engine.

For Vehicles Equipped with an Air Bag

An air bag inflates with great force. **DO NOT** place objects, including both installed or portable wireless equipment, in the area over the air bag or in the air bag deployment area. If in-vehicle wireless equipment is improperly installed and the air bag inflates, serious injury could result.

European Union Directives Conformance Statement



This product is in conformance with the requirements of the applicable EU Council Directives.

Declarations of Conformance with the requirements are located at:

Motorola Ltd.
European Cellular Subscriber Division
Midpoint, Alençon Link
Basingstoke, Hampshire RG21 7PL
United Kingdom









APPROVED for connection to telecommunications systems specified in the instructions for use subject to the conditions set out in them.



S/1357/4/V/503894





About Your Phone, Battery and SIM Card

Special Keys

-  Turns the phone on and off.
-  Accept call, setting, option.
-  Reject call, setting, option.
-  Enter the Quick Access menu.
-  Press to access the Options and Phone Book menus.
-  Press both simultaneously to lock the keypad; also use to scroll left and right.
-  Press to scroll up and down.
-  Press to call Voicemail.

 The shape of the keys that appear in the manual may vary slightly from those on the phone.

Volume Buttons

The Volume buttons ( ) are on the left-hand side of your phone. The buttons are used for adjusting the keypad, earpiece and ringer volume. A volume meter will display the current volume setting. The meter will disappear after a short time, or if you press  or .

- To adjust the keypad and earpiece volume, press the buttons with no other features selected.
- To adjust the ringer volume, first select the 'Adjust Ring Volume' option in the Phone Setup Menu and then use the buttons to set the required volume.

 If you receive a call and you do not want to answer it immediately, you can press the volume buttons to stop the phone from ringing. This will not answer the call.

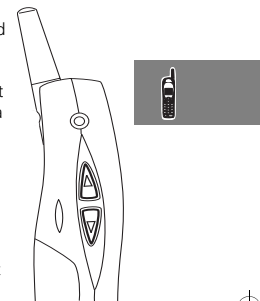

The Display

The display on your phone can show alphanumeric characters as well as useful information symbols. The various elements of the display are as follows:

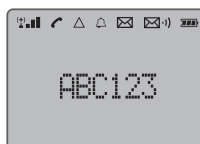

ABC123

Characters are used to display messages and telephone numbers.



Signal Strength. The more segments displayed in the bar graph, the better the signal strength.



In Use. Displayed when a call is in progress.



Home Zone. Availability depends on your service provider.



Roam. Displayed when you are registered on a system other than your home system.



Ringer On. Displayed when the call ringer is selected. If you select the No Ring option, this symbol will be displayed with a line through it.



Short Message Service. Displayed when the phone has received a message. The symbol will flash when your message storage area is full.



Voicemail Waiting Indicator. Displayed when you have a voice message waiting. The availability of this feature depends on your service provider.



Battery Charge Indicator. The more segments displayed, the greater the battery charge.



Icons are displayed when you are in the Quick Access menu.



Indicates that a menu item is currently selected.

In addition, when you are expected to press the **OK** key, a prompt will appear in the display, for example **Completed**.

Low Temperature Use

The liquid crystal display used in your phone will behave differently at extremely low temperatures. You may notice that the display responds slowly to key presses; this is to be expected and does not affect the phone operation in any way.

Earpiece Connector

 The earpiece connector is supplied with a protective plug inside the receptacle. Please remove the plug before inserting the headset.

The earpiece connector is on the left-hand side of your phone, above the volume buttons. Use this connector for the headset accessories available from your *Motorola* stockist.

Looking After Your Phone

- Never leave your phone or battery in extreme temperatures (over 60°C), for example behind glass in very hot, direct sunlight.
- To clean your phone, use a moistened or antistatic cloth. Do **not** use a dry or electrostatically charged cloth.

Your Battery

Installing the Batteries

New batteries are supplied uncharged and fitted within a protective battery carrier. To remove the batteries, press the release catch on the battery carrier and open the cover.

To install the batteries in your phone:

- 1 Press the release catch of the phone battery cover and slide the battery cover towards the bottom of the phone.
- 2 Align the positive and negative (+ and -) connections on the battery with the positive and negative (+ and -) connections within the phone.
- 3 Press the battery towards the connections and push it downwards until it clicks into place.
- 4 Replace the phone battery cover.

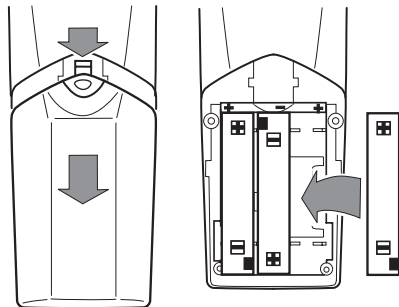

Important Battery Information

- ⚠ **Always treat your batteries with care. See 'Batteries', at the beginning of this manual.**
- ⚠ **Never leave your battery in extremely high temperatures (over 60°C), for example behind glass in very hot, direct sunlight.**
- ⚠ **Only Motorola Original Accessory batteries can be charged in the phone. This is to protect you and your phone from the risks of incorrect charging.**



Charging a New Battery

New batteries are supplied in a totally uncharged state.

To ensure maximum battery performance, a new battery (or battery that has not been used for several months) should be charged for at least 14 hours before use.

- ⚠ **A new battery will require several full charge/discharge cycles in order to achieve its optimum performance.**
- ⚠ **A new battery, or a battery that has not been used for several months, may cause a premature fully charged indication. Ignore this indication and let the battery charge for several more hours, remove and re-insert the battery into the charger, and charge for an additional 14 hours.**
- ⚠ **Your batteries will not charge if they are not matched properly to the phone connection markings (+ and -). Please ensure that you have installed the batteries properly before initiating a charge.**

To ensure that you enjoy maximum battery life and use your battery to its fullest capacity:

- The battery should be at or near room temperature when charging.

Battery Performance and Maintenance

- Best battery performance will be achieved when you regularly charge and discharge batteries as instructed in this manual.
- Battery performance is greatly affected by network coverage.
- Set **Battery Saving Mode** to On (see 'Phone Setup Menu') and/or **Frequency of Search** to Slow or Medium (see 'Network Selection Menu').
- If left unused, a fully charged battery will discharge itself in approximately one month.
- When not in use, store your battery uncharged in a cool, dark and dry place.

Removing Your Batteries

1 **Switch off your phone before removing batteries.**
Failure to do so may damage your phone memory.

1 Press the release catch of the phone battery cover and slide the battery cover towards the bottom of the phone.

2 Remove the batteries.

 *There is a finger space opening at the bottom left hand side of the phone that will allow for easier removal of the batteries.*

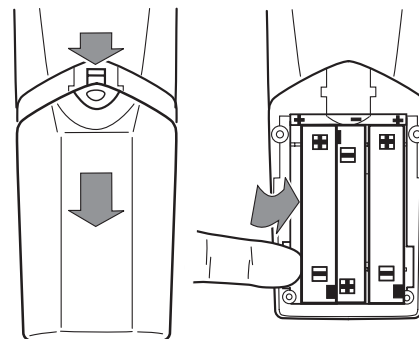

Charging Your Battery Using the Travel Charger

 Depending on the state of the batteries, a phone call may not be supported during charging. If the batteries are low or nearly depleted, it is recommended that you allow the batteries to charge before placing or receiving a call.

The travel charger can power the phone and charge a fitted battery. You cannot power the phone without a battery.

 **Ensure that the local mains voltage at your location matches that of your travel charger.**

Install the batteries into your phone (see 'Installing the Batteries').

To charge your battery:

1 Ensure that your batteries are installed properly.

 Charging will not occur if batteries are not installed properly, or if the charger is not fully inserted.

2 Connect the travel charger to the phone.

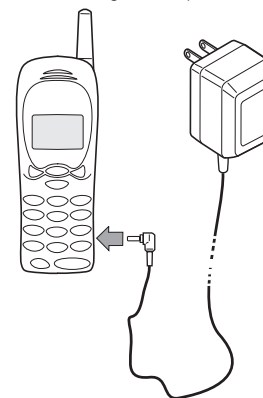

3 Insert the travel charger plug into a suitable mains power socket.

The phone can be charged in the powered on or powered off positions. When the phone is powered on a beep-tone is heard and the battery icon flashes when charging begins. When the phone is powered off Charging Battery is displayed and the battery icon flashes when charging begins.

 When you begin a charge it is recommended that the phone is fully powered on or powered off before inserting the charger.

 *The beep-tone on the phone will not occur if the batteries are installed improperly. The beep-tone may take two minutes to occur with new or fully drained batteries.*

The state of charging is monitored and displayed by your phone. See 'Battery Meter Indicators' later in this section for details.

Low Battery Warning

When the battery level is low and only a few minutes of talk time remain, a warning signal (two double beeps) will sound, and **Low Battery** will be displayed.

When the battery is completely discharged, your phone will turn off.

Battery Indicators

Your phone monitors and displays information about your battery. The following message will appear on the display, as the condition occurs:

Low Battery The battery charge is low. The battery should be recharged.

Battery Meter Indicators

The battery meter displays different messages depending on the batteries attached, and whether or not there is an external power source. The battery meter is found in the Call Related Features part of the Options Menu.

Charging Battery The battery is being charged.

Charging Complete Charging is complete.

 *When the battery is completely discharged, you must charge the battery for one minute or longer before you can make or accept a phone call.*

 *For optimal charging do not disconnect the charger until **Charging Complete** is displayed on the phone.*

Your SIM Card

Your SIM (Subscriber Identity Module) card was supplied by your Cellular Service Provider when you bought your phone. You will not be able to make or receive calls if you do not have a SIM card inserted in your phone.

 *Some networks allow you to make emergency calls without a SIM card inserted.*

The SIM card is a 'Smart Card' that contains your phone number, service details and memory for storing Phone Book numbers and messages. You can therefore use your SIM card in someone else's GSM phone and you will be charged for the call.

Like a bank or credit card, you should keep your SIM card secure. Do not bend or scratch your card and avoid exposure to static electricity or water.

 **Switch off your phone before inserting or removing the SIM card. Failure to do so may damage the memory on your SIM card.**

SIM Card Insertion/Removal

- 1 Switch off your phone by pressing and holding the  key, remove the battery cover and the batteries.
- 2 Slide the SIM cover towards the right and lift up the left side of the cover.

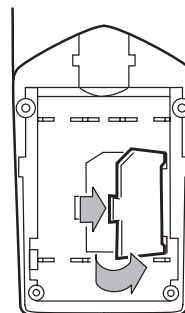

- 3 If necessary, remove the SIM card from the recess in the base of the phone.

- 4 Place the SIM card into the recess in the base of the phone so that the notch is in the top left-hand corner.

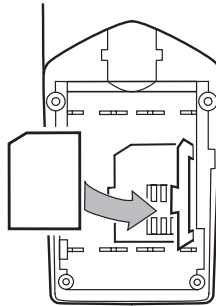

- 5 Replace the SIM cover, then press and slide it to the left to lock it into place.
- 6 Replace the batteries and battery cover.

If the SIM card is inserted the wrong way round, or damaged, the **Check Card** message may be displayed. Remove the SIM card, check that it is the right way round and then re-insert it into the phone.

If either of the **Bad Card See Supplier** or **Blocked See Supplier** messages are displayed, then you will need to contact your Cellular Service Provider.

Making and Receiving Phone Calls

Switching the Phone On and Off

To switch the phone on or off, press and hold the **(O)** key. If you switch the phone on and there is no SIM card inserted, you will be asked to insert one. Once inserted, the phone will check that the SIM card is valid.

A number of messages will then be displayed:

- Enter PIN - a request to enter the SIM card PIN code (if required).
- Enter Phone Unlock Code - a request to enter the phone unlock code (if required).
- Searching... followed by a network name - as the phone searches and then finds a suitable network to connect to.

Entering Your SIM Card PIN Code

To enter the PIN code, enter **[PIN Code]** **(OK)**.

As you type in each digit of the PIN code a * character will be displayed.

If you make a mistake, press and release the **(C)** key to remove the last digit. Holding the **(C)** key down will remove the entire entry.

When the PIN code is complete press the **(OK)** key.

If the PIN code entered is incorrect, the warning message Wrong PIN will be displayed, followed by Enter PIN.

! If the PIN number is entered incorrectly three times in a row, your phone will automatically lock-up and the Blocked message will be displayed. See 'Unlocking Your Phone' for details on unblocking your phone.

The PIN code can be changed, see 'Change SIM PIN Code' in the **Phone Setup Menu** section for more details.

OK Entering Your Unlock Code

If your phone displays the message Enter Phone Unlock Code you must enter your unlocking code by entering

[Unlock Code] **(OK)**.

The unlock code is a four digit number which is set at manufacture to **1234**. The code can be changed, see 'Change Unlock Code' in the **Phone Setup Menu** section for more details.

If you forget your unlock code, press the **(MENU)** key. This will display the 'Change Unlock Code' option. Enter **(OK)**

[Security Code], enter a new unlock code, and press **(OK)**.

Locking the Keypad

Press the **(*)** and **(#)** keys simultaneously to prevent accidental usage of the phone. To remove the lock, press **(*)** and **(#)** simultaneously. All keys with the exception of the **(O)** key will be disabled. You can still answer an incoming call by pressing **(OK)** when the keypad is locked.



Making a Phone Call

To make a phone call, your phone must be switched on and unlocked.

It will not be possible to make a phone call unless you are in an area where there is a GSM900 or 1800 service. When a service has been found, a series of rising bars, , will show the signal strength.

There are a number of different ways to make a phone call:

- Using the digit keys.
- Using automatic redial.
- Redialling the last number called.
- One-touch dialling a Phone Book entry*.
- Dialling a Phone Book entry*.
- Calling an embedded number in a message.

 *Your phone contains a 'phone book' that can be used to store names and telephone numbers. See 'What is the Phone Book?' for further details.

The simplest method of making a phone call is to enter the number using the digit keys then press **OK**.

 If you make a mistake, press and release the **C** key to remove the last digit. Holding the **C** key down will remove the entire number.

Your phone will then attempt to make the phone call. The display will show **Call in progress** to show the call attempt is being made. If the call is not answered, pressing **OK**, at this point will end the attempt.

When the phone call is answered, the display will change to **Connected** for a few seconds, followed by **End Call?**.

To end your call press **OK**.

Automatic Redial

If your call attempt does not succeed, the message **Redial?** will be displayed for five seconds. Pressing **OK** at this point will automatically redial the phone number.

When the call is answered, you will hear a short ring tone.

The maximum number of redial attempts is set by your Cellular Service Provider. If the phone call cannot be connected within this maximum, the message **Redial Failed** will be shown.

Redialling the Last Number Called

 When in standby mode, press **OK OK**.

Alternatively, you can retrieve the last number dialled using the 'Last Ten Calls' feature in the Phone Book menu.

OK One-Touch Dialling Phone Book Numbers

To quickly retrieve and dial a number stored in the first nine locations of your Phone Book¹, press and hold the appropriate digit key. For example, pressing and holding **2** will dial the phone number stored in location 2 of your Phone Book.

 You do not need to press **OK** to call the number.

1. The Phone Book entries that you are able to access will depend on the One-Touch Dial Setting option in the Phone Book menu.

Dialling Phone Book Numbers

Alternatively, enter the phone book **Location** number followed by **#OK**.

Calling an Embedded Number in a Message

Details on how to call a number embedded in a message are given in the **Messages Menu** section.

International Phone Calls

To make an international phone call press and hold the **0** key. After a couple of seconds the international dialling prefix + will appear in the display, this allows you to call from any country without knowing the local international access code.

Now enter the country code, followed by the phone number. The country code follows the conventional format, 49 for Germany, 44 for the UK, 46 for Sweden, etc.

Just like a conventional international call, remove the leading '0' of the area code when you dial.

Inserting Pauses Into Phone Numbers

To obtain a three second 'pause' character in a phone number, press and hold the ***F** key for a couple of seconds, the pause symbol **▣** will appear.

The pause character produces a three second delay whenever it is used. However, the first pause character in a phone number is a special case, it will not begin its delay until the call is answered.

Pause - A Working Example.

If, for example, you have a tone-based voicemail system on 555-6911, with a mailbox number 1066 and password 2001. Then you may dial the following number:

5556911▣1066▣2001**OK**.

The first part of the number would be used to call the voicemail system.

When the call is answered the first pause will produce a delay of three seconds before the tones for 1066 are sent to select the mailbox.

There will be a second pause of three seconds before the tones for 2001 are sent as the password.

GSM Emergency Calls

The world-wide GSM standard provides a single, uniform number, 112, to dial in cases of emergency.

Provided that your phone has found a network, you will be able to make an emergency call. The call can be made regardless of any security codes and, depending on the network, with or without a SIM card inserted.

The emergency call will be directed to a central emergency operator.

To dial the GSM emergency number, press **112abcOK**.

While the emergency call is being made and connected, the display will show **Emergency Calling**.

 *Additional emergency numbers may be supported based on your subscription. Please see your service provider for additional information on these services.*



Receiving a Phone Call

To receive a phone call:

- Your phone must be switched on and unlocked.
- You must be in an area where there is GSM900/1800 service.
- Your Call Diversion and Call Barring settings should not be set to divert or bar incoming calls.

When your phone receives a call, it will ring and the display will show the **Call** message (if you have Caller Line Identification, the caller's number or name will be displayed instead).

To answer the call, press **OK**.

If you do not wish to answer a call you can either:

Press and release the **C** key. If you have enabled the 'Detailed Diverting - If Busy' or 'Divert when unavailable' options in the Options Menu, the caller will be diverted to the forwarding number, otherwise the caller will hear the busy tone.

or

Press and hold the **C** key. This will reject the incoming call. No call divert option will be offered.

If your phone rings and you do not answer it, the message **Unanswered Call** will be displayed to show you that a call attempt was received.

Ending a Phone Call

To end a phone call, press **OK** or **C**.

In-Call Menu

The "In-Call" menu provides access to additional functionality during a call.

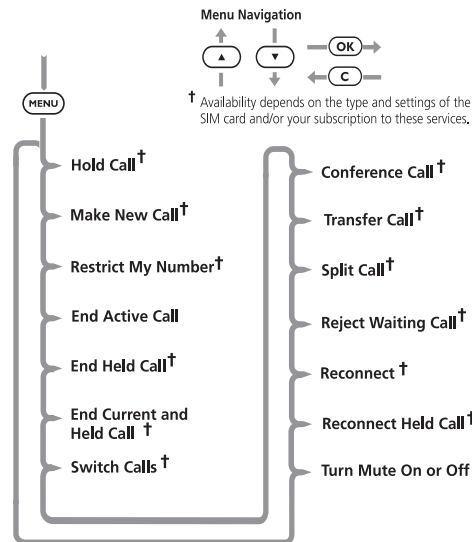

Entering the In-Call Menu

The "In-Call" menu is accessed by pressing the **MENU** key during a call.

Leaving the In-Call Menu

To leave the "In-Call" menu press the **C** key.

In-Call Menu Options

The options listed in the "In-Call" menu will dynamically change depending on the current call state. The following list contains all of the possible options in the "In-Call" menu.

Only some of the options will appear at any given time. The order of the options may vary.

Hold Call

This option will put the active call on hold.

Make a New Call

This option allows you to make another call.

Restrict My Number

This option allows you to make a call without the remote user getting advanced warning of the number.

End Active Call

This option terminates the active call, and makes the call that was previously on hold, the active call.

End Held Call

This option will terminate a held call.

End Current And Held Call

This option will terminate all connected calls.

Switch Calls

This option allows you to switch between the active call and the call that is on hold.

Conference Call

This option connects you with up to five other telephones on one call (see 'Making a Conference Call').



Transfer Call

This option transfers a call to another telephone (see 'Transfer Call' later in this section).

Split Call

This option allows you to separate an individual from the main Conference Call.

Reject Waiting Call

This option will reject a waiting call.

Reconnect

This option will make the call on hold the active call.

Reconnect Held Call

This option is similar to Reconnect, but will appear if you have a call on hold, and a call waiting. Reconnect Held Call will make the call on hold the active call.

Turn Mute On or Off

Temporarily turns the microphone off during a phone call. Reselect this option to resume your conversation.

OK Call Holding and Call Waiting

Your phone supports the GSM options of Call Holding and Call Waiting. Using these options you can place a current phone call on hold and accept an incoming call or start a second call (See 'Call Waiting' in the 'Call Related Features' menu for details of how to control this feature).

Call Holding and Call Waiting Scenarios

The display will automatically change according to the status of your current call (or calls) and will propose the option that you are most likely to want. Press **OK** to accept this option or press **MENU** and then **▼** to scroll through the "In-Call" menu for the alternative options. By following this procedure you will find that even the triple combination of an active call, a held call, and a call waiting is easy to manage.

The following points summarise the more common situations:

- To put an active call on hold, press **MENU**, the display will show Hold Call Select? - press **OK** to put the call on hold. To reconnect the call, press **OK**.
- To put an active call on hold and make another call, first put the active call on hold, then press **MENU** and select the Make New Call option¹.
- To switch between an active call and a held call press **OK** at the Two Calls Switch? prompt.

¹ A quicker method of making another call is to enter the number to be called directly and press **OK**. Your phone will place the current call on hold and attempt to call the number entered.

- To accept a waiting call during an active call, press **(OK)** at the Call Waiting Answer? prompt. The active call will be placed on hold. If you prefer to end the active call before accepting the waiting call, press **(MENU)** and select the End Active Call option.
- To reject a waiting call, press **(MENU)** and select the Reject Call Waiting option (or simply press the **(C)** key).

 *If you have an active call, a call on hold and a call waiting, you cannot accept the waiting call until you end either the active call or the held call, or join the active and held calls.*

Call Holding and Call Waiting Messages

During Call Holding and/or Call Waiting operations, your phone may display one or more of the following messages:

Transferring

A request to hold the active call, swap the active with a held call, or add a member to a Conference Call, has been made.
or

A request to reconnect the held call has been made.

 *If you are in the process of placing a call on hold and Transferring appears in the display, you need to press **(OK)** to resume the current call. If you press **(C)** when you are trying to place a call on hold, it will end the current call.*

Hold Failed

The request to hold a call has been unsuccessful.

Cannot Hold Second Call

A call is already on hold, you cannot place two calls on hold at the same time.

Connection Failed

The held call could not be made active again.

Busy Try Later

Your phone is still working on a previous command. Wait a short time before repeating the command.

Anonymous

The person who is calling you has blocked their number from appearing on your phone.

Unavailable

The network is unable to provide the caller's number.

Conference Unsuccessful

The request for Conference Call has been unsuccessful.

Transferring Call

A request to transfer a call has been made.

Transfer Unsuccessful

The request to transfer a call has been unsuccessful.



Making a Conference Call

This option joins the active call with a held call. With Conference Call, you can have a conference with up to five other telephones. At any time during your call, you can add, disconnect or separate individuals from the Conference Call using other "In-Call" menu options.

 You must subscribe to both Conference Call and Call Waiting Supplementary Services to be able to use this feature.

Initiating a Conference Call

To initiate a Conference Call, place the active call on hold, and dial another phone number. You will then have one active call and one call on hold.

Press the **(MENU)** key to enter the "In-Call" menu and select **CONFERENCE CALL**. The currently active call and the call on hold will then join into one Conference Call.

Managing a Conference Call

While in a Conference Call, you will have the option to add new calls to the Conference Call or separate one of the members from the Conference Call.

Adding a New Call

There are a number of different ways to add new calls to the Conference Call:

- Using the digit keys.
- Using the **Make New Call** option from the "In-Call" menu.
- Recalling a Phone Book Entry using Quick Access.
- Answer Call Waiting.

No matter which method is chosen to add a new call, the original Conference Call will be first placed on hold while the new call is being connected. You must then enter the "In-Call" menu and select **CONFERENCE CALL** to join the New Call with the original Conference Call in progress.

Separate One of the Members in the Conference

During a Conference Call, you will also have the option to separate a selected member from the main Conference Call.

 In order to separate a member from the main Conference Call, there must not be any calls on hold.

Press **(MENU)** during a Conference Call and select **Split Call**. You will then be presented with the phone number or name of all members of the Conference Call. Use the scroll keys to find the selected member of the Conference Call. Once the desired member is selected, press the **(OK)** key and select **Split Call**.

At this point, the selected call will be separated from the main Conference Call and private conversation between you and the selected member is possible.

To re-join all the parties again, select **CONFERENCE CALL** from the "In-Call" menu.

Transfer Call

Transfer Call transfers a call to another telephone. There are two ways to transfer a call; *before or after* the third party is connected.

 You must subscribe to both *Conference Call* and *Call Waiting Supplementary Services* to be able to use this feature.

Initiating Transfer Call Before the Third Party is Connected

To transfer a call to another telephone, press the **(MENU)** key and select *Transfer Call* from the "In-Call" menu. Enter the number where the call will be transferred and press **(OK)**.

Your phone will then attempt to transfer the call. The display will show *Transferring Call* followed by *Call Transferred*. When the call has been successfully transferred, you will be disconnected automatically.

Initiating Transfer Call After the Third Party is Connected

If you already have an active call and a call on hold, press the **(MENU)** key and select *Transfer Call* from the "In-Call" menu. Your phone will then attempt to transfer the active call to the call on hold. The display will show *Transferring Call* followed by *Call Transferred*. Once the call has been successfully transferred, you will be disconnected automatically.





Using the Options Menu

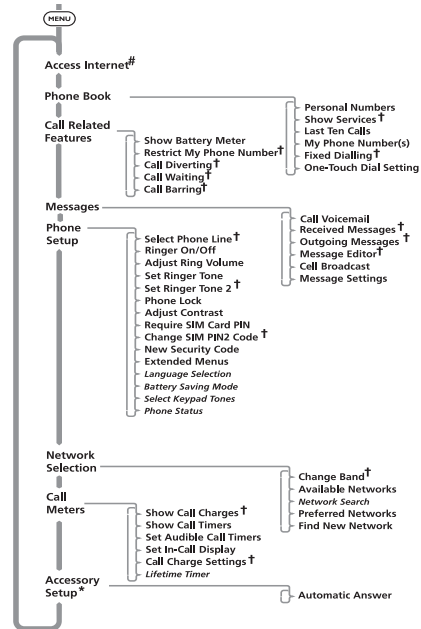

Menu Navigation

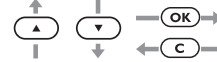

Items shown in *Italics* are available only when **Extended Menus** are switched on.

If your service provider has added their own menu, Access Internet will not be the first item in the Options menu.

† Availability depends on the type and settings of the SIM card and/or your subscription to these services.

* The **Accessory Setup** option is available only when a car kit or headset is fitted.





Access Internet

 *Access Internet is a network and subscription-dependent feature. Contact your service provider for details about the mobile internet services based on the WAP (Wireless Application Protocol) technology that they provide.*



Your phone has mobile internet access. This allows you to use the mobile internet services available from your service provider, for example, financial, sport, travel and entertainment information services.

This section explains:



- some of the common display features
- how to set up your phone for mobile internet access
- how to start a mobile internet session
- how to use and end the mobile internet session.

Common Display Features

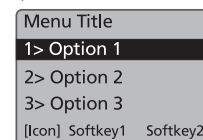
Your service provider determines the layout and information that appears on the display. This example display illustrates a typical mobile internet screen and the soft keys you use to select and navigate through options.



Using the Main Menu

To display the Main Menu, press and hold  until the Main Menu appears. You can access the Main Menu only during a mobile internet session. Then scroll up or down to highlight the appropriate menu option and press  to select it. The Main Menu includes special commands, for example:

- Help: provides help, if available, for the previously-highlighted option.
- Home: returns you to your home page provided by your service provider.
- Mark site: allows you to add a site to your Bookmarks folder.
- Setup: contains the options to set up your mobile internet access.



Using Bookmarks

Select **Mark site** from the Main Menu. When your phone prompts you for a **Bookmark?**, press any key from **(1)** to **(9)**. A **Stored XXX** message confirms that the bookmark key is set. To return to the bookmark during a mobile internet session, press and hold the appropriate key.

Using the Soft Keys

To select a soft key from the display during a mobile internet session, press **(OK)** or **(MENU)**. The soft keys change so that they are appropriate for the current display, for example, **Quit**, **OK**, **Back** or **View**. In the example display, **(MENU)** selects the **softkey1** and **(OK)** selects the **softkey2**.

Mobile Internet Icons and Messages

Icon or Message	Description
Sending)))))	Sending data to the internet.
Receiving ((((((Receiving data from the internet.
Connecting	Connecting to the internet.
Working	Performing an internet activity.
[struck out key symbol]	Non secure internet connection.

The internet service you receive determines the icons and messages that appear on the display.

Setting Up for Mobile Internet Access

Your service provider may set up your mobile internet access automatically.

To set up your mobile internet access manually, you will need the following information:

- **Primary Data Gateway:** this is the IP address of the gateway through which you will access the mobile internet. The IP address is in the format 123.456.789.123.
- **Phone Number:** this is the number that your phone will call to access the internet; your Internet Service Provider (ISP) issues this number.
- **User Name:** this is your user name, provided by your ISP.
- **User Password:** this is your password, provided by your ISP.
- **Baud Rate:** this is likely to be 9600, the standard data rate for GSM phones.
- **Idle Time Out:** this is the time the phone will wait before hanging up if it detects no internet activity; usually 600 seconds; maximum 1000 seconds.
- **Line type:** this is the type of call you make to your ISP, either modem or ISDN.
- **Connection Type:** this is either Non-Transparent or Transparent, depending on your service provider.





Also ensure that your mobile phone number shows when you select the menu option **My Phone Number(s)**, under the **Phone Book** Main Menu. This could be used as your account number by the Primary Data Gateway. If your number is not shown, add it by following the instructions in **My Phone Number(s)**.

Select the menu option **Access Internet** and press the **OK** key. Press and hold the **MENU** key until the **Main Menu** appears. Scroll down through the options to **Setup** and press the **OK** key. Enter the information listed above at the appropriate menu item by first selecting the item and choosing the softkey to edit it as necessary.

When you have entered all the appropriate information, exit the **Main Menu** by pressing the **ESC** key repeatedly. Turn your phone off and then on again to make sure you register all changes. You will then be ready to start a mobile internet session.

Starting a Mobile Internet Session

Press **↑**. Select the Quick Access feature (**Access Internet**).

The menu option **Access Internet** starts a mobile internet session.

When you start a mobile internet session, you will see the messages **Connecting**, **Sending >>>** and **Receiving <<<** before your home page appears. Typically, an ISDN connection will take approximately 10 seconds and a modem connection will take 30 seconds.

Using the Mobile Internet Session

Selecting Options Within a Mobile Internet Session

If the Internet page has a list of menu options, scroll up or down to highlight the appropriate menu option and then press **OK** to select it. Press **ESC** to return to the previous screen.

When the text for a menu option is too wide for the screen, the phone uses two screens and repeats each half of the menu list until you make a selection.

Editing Text Within a Mobile Internet Session

You edit text in a mobile internet session in a similar way to editing text in all other phone functions, but you can use softkeys to enter symbols and numbers easily. See **How to Enter Alphabetic Characters**.

Making and Receiving Calls During a Mobile Internet Session

To make a call, you must end the mobile internet session and make your call in the normal way.

You can not receive voice calls during an on-line mobile internet session. When an on-line session is in progress, the phone displays the **In Use** icon. If you receive a call during a mobile internet session the phone diverts the call (See **Call Diverting**).¹

If you receive a call during an off-line mobile internet session (the **In Use** icon is not displayed) your phone prompts you to **Answer?**. Press **OK** to accept the call or press **ESC** to reject it.

1. Availability of this feature depends on your service provider.



If you answer the call, WAP Session Paused - Resume? appears when you end the call. Press **OK** to resume your mobile internet session or press **C** to return to the idle phone display.

Internet Service Alerts

You do not need to be using the mobile internet to receive an internet service alert. If you receive an alert, your phone:

- emits an alert tone (depending on the 'Ringer On or Off' setting)
- displays a pop up screen with appropriate alert details.

Press **OK** to display the contents of the alert or press **C** to reject it.

Ending a Mobile Internet Session

Press the **C** key repeatedly until the Internet home page appears. Press **C** again to end the mobile internet session.

Summary of Keys Within a Mobile Internet Session

Key action	Effect in mobile internet	Effect in text editor ^a
Press MENU	Selects the first soft key (Softkey1 in the example).	
Press OK	Selects the second soft key (Softkey2 in the example).	
Press and hold MENU	Displays the mobile internet menu.	
Press C	Takes you back to the previous screen.	Deletes the character in front of the cursor.
Press C repeatedly	Takes you back to the Internet home page.	Deletes all the characters in the edit area.
Press C again	Ends the mobile internet session.	
Press I ... WAP	Selects a menu option in a list	Inserts an alphanumeric character.
Press and hold I ... WAP	Takes you to a bookmarked page.	Changes the case for the next alphanumeric character.
Press ▲ or ▼	Takes you up or down through a list of menu options.	Moves the cursor one position to the left or one position to the right.



^a For full details, see see 'How to Enter Alphanumeric Characters'.



Accessing MyMotorola.com¹

Press . Select the Quick Access feature (My Motorola MyMotorola).

The My Motorola option on the mobile internet menu allows you to go directly to the MyMotorola.com web site.

Go to MyMotorola.com today!

MyMotorola.com is a powerful, free tool that allows you to get the most from your phone.

To access the power, simply go to <http://www.mymotorola.com> and register. Complete the 'Join Now' registration form with some information about yourself and your phone to access support tools, personal information tools and a list of WML web sites that work great on your new Talkabout phone.

By downloading TrueSync™ software and going to <http://www.mymotorola.com>, you can keep your phone, your desktop organiser and your web-based address books synchronised and keep them instantly up-to-date and accessible.

You can enjoy the freedom of accessing your personal data from your phone, wherever you are. You can also access MyMotorola.com from any personal computer with an Internet connection, anywhere in the world.

MyMotorola.com gives you **the power to take your world with you:**

The power to be efficient. Enter information once - access and update your personal mobile organiser information, anywhere.

The power to stay informed. View your mobile bookmarks: the mobile Internet sites of your choice, for business or for pleasure, customised for your phone.

The power to relax. Enjoy exclusive access to games, giveaways and prizes. Explore your personal, mobile entertainment options and have fun with your friends.

Take your world with you. Visit MyMotorola.com today.

1. Availability depends on the type and settings of the SIM card, and/or your subscription to these features.



The Phone Book Menu

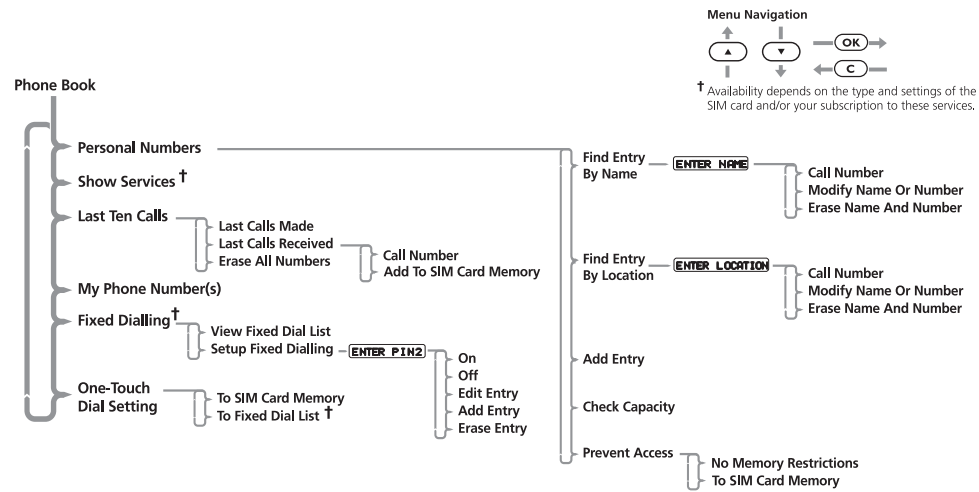



Using the Phone Book Menu

You can store names and telephone numbers as entries in the *Personal Numbers list* and in the *Fixed Dial list* on your SIM card. The amount of *Personal Numbers* entries will vary depending upon the type of SIM card issued by your Cellular Service Provider.

You can also store up to 40 entries in a Fixed Dialling list if you have this feature. Fixed Dialling allows you to limit use of your phone to particular numbers.

Each Phone Book entry comprises:

- A phone number - up to 20 digits*.
- A name - up to 50 characters* but typically 10 or less.
- A location label - from 1 to 255* in your Personal Numbers list, or 1 to 40* in your Fixed Dial list.

* *Dependent on SIM card.*

How to Enter Alphabetic Characters

The **0**, **1**, ..., **8** and **9** keys are used to enter alphabetic characters, for example when storing names in the Phone Book or when creating messages.

For example, if you press the **5** key, the first displayed character will be J. If this is not the required character, then you can press the same key again to show K. Another press will display L, another... will display 5. Your phone will continue to scroll through the characters available on the selected key with each new key press.

A long press of any of the keys will switch all the characters to lower case, a second long press will switch back to upper case.

To enter the next character press the appropriate key. If, however, the next character is on the same key as the previous character you will first need to press the **#** key. Pressing the **#** key a second time will produce a space.

If a mistake has been made, you can go back to the incorrect character by pressing *****.

Characters can be removed from the display by pressing the **C** key.

The character before the cursor (■) is the character which will be deleted.

Press the **OK** key to store the information.



Available Characters

Press the appropriate keys to get the following characters:

- 1 Space . 1 ? ! , @ _ & : " () ' ` ~ i % £ \$
Space . 1 ? ! , @ _ & : " () ' ` ~ i % £ \$
- 2 ABC 2 Ä Å à å æ ø ç
a b c 2 ä å à å æ ø ç
- 3 DEF 3 é ê ë ì
d e f 3 é ê ë ì
- 4 GHI 4 Ì Í Î Ï
g h i 4 Ì Í Î Ï
- 5 JKL 5 Æ
j k l 5 Æ
- 6 MNO 6 Ñ Ò Ó ô õ
m n o 6 ñ ò ó ô õ
- 7 PQR 7 Ò Ó Ô Õ
p q r 7 ò ó ô õ
- 8 TUV 8 Ü Û
t u v 8 ü û
- 9 WXYZ 9 Ξ Ψ
w x y z 9 Ξ Ψ
- 0 + - 0 x * / = > < #
+ - 0 x * / = > < #

The top line for each key shows the upper case characters, the lower line shows the lower case.

Personal Numbers

The Personal Numbers sub-menu is used for creating and managing your list of personal numbers.

Find Entry By Name

This option is used to select a telephone number from a list of alphabetically sorted Phone Book names.

Once selected, this option will display the message Enter Name. You can enter a maximum of three characters from a name but you do not need to enter all three characters to begin a search.

The Phone Book entries will be searched and the first alphabetically matching entry will be displayed.

If there isn't a name matching your entry, the nearest alphabetically matching entry will be displayed.

If you do not enter any name information, the first alphabetical entry will be displayed.

If there are no names stored, No Names Stored will be displayed.

To display adjacent Phone Book entries use the **◀▶** key. When the desired name is displayed press the **OK** key to select it. The phone then enters the options sub-menu for Find Entry By Name. See 'The Options for 'Find Entry By ...'.



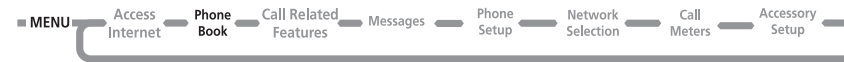

Find Entry By Location

Location (#)

This option is used to select a telephone number from a list of numerically sorted Phone Book locations.

Once selected, this option will display the message Enter Location. You can now enter a location number. If the entered location is not valid, a timed message Range 1-XXX will be displayed and the phone will return to the Enter Location menu item.

The Phone Book entries will be searched and an entry will be displayed.

If you enter a location number for which there is no entry, Location Empty will be displayed and the nearest non-empty location will be selected instead.

If you did not enter a location, the first numerical entry will be displayed.

If there are no numbers stored, No Numbers Stored will be displayed.

To display adjacent Phone Book entries use the (v) key. When the desired name is displayed press the (OK) key to select it. The phone then enters the options sub-menu for Find Entry By Location. See 'The Options for 'Find Entry By ...''

The Options for 'Find Entry By ...'

Once a Phone Book entry has been selected, it can be called, modified or deleted.

Call Number

This option is used to call the selected Phone Book telephone number.

Modify Name or Number

This option is used to change the selected Phone Book entry.

The entry's current telephone number and name will be presented, in turn, for modification. You can accept the current settings or modify as required.

Erase Name and Number

This option is used to erase the selected Phone Book entry.

Simply press the (OK) key when the phone displays the message Erase Name And Number. The option will display the timed message Erased XXX and then return to the Find Entry menu item.

Add Entry

Press (↑). Select the Quick Access feature (Add to SIM?).

This option is used to add (store) entries to the SIM Card.



Check Capacity

This option is used to check the number of free entries in the SIM card memory area.

Prevent Access

This option enables you to prevent access to the Personal Numbers list.

To SIM Card Memory, No Memory Restrictions

You can prevent access to all entries in the SIM card memory. To cancel all access restrictions use the No Memory Restrictions option.

When you change the restrictions, you will be requested to enter the Security Code before the change is made.

Show Services

Press **↑**. Select the Quick Access feature (**☰** Show Services?).

This option displays a list of phone numbers and services provided by your Cellular Service Provider.

ⓘ Availability depends on the type and settings of the SIM card, and/or your subscription to this feature.

Last Ten Calls

These options allow you to review your most recently used phone numbers. Depending on the option you choose, you can then redial a phone number, store a phone number in your phone book, or erase all of the phone numbers.

After you select an option, use the **↓** key to scroll through the list of phone numbers. Press the **OK** key to proceed.

Last Calls Made

Select this option to redial the phone number of any one of the last ten calls made.





Last Calls Received

Press **(↑)**. Select the Quick Access feature (**Last Received Calls?**).

Select this option to redial the phone number of any one of the last ten calls received. You can store any of the phone numbers in your phone book.

You will only see numbers in the Last Calls Received list if you have Caller Line Identification.

When you scroll through your last ten calls, each call appears with a call position number, for example: 1+, 2-, 3+ ... 10+. A + symbol indicates that you answered the call. A - symbol indicates that you did not answer the call.

Press the **(OK)** key to select a phone number. You can then scroll through and select one of the following options:

Call Number

Select this option to call the phone number.

Add to SIM Card Memory

Select this option to add the phone number details (including any details you have added) to your SIM card memory. If the name in the received call does not appear in your phone book, the phone prompts you to Enter Name and Enter Location. For further details, see 'Add Entry' in this section.

Erase All Numbers

This option erases all the numbers stored in your Last Ten Calls Made and Last Ten Calls Received lists.

The Last Ten Calls lists will be erased when a new SIM is inserted in the phone.

My Phone Number(s)

This option allows you to access your cellular phone numbers so that you can retrieve or modify them when required. For example, if you have difficulty remembering your cellular phone number, store it with the name My Phone and then you will be able to retrieve the number as required.

The My Phone Number(s) list is stored on your SIM card.

When you select this item, the first location will be displayed. Use the **(↓)** key to scroll through the phone numbers stored.

To enter or change a number, scroll to the location and press **(OK)**. You will be prompted to enter a phone number and then a name. Press **(OK)** to store the information.

Depending on your Cellular Service Provider, you may find that one or more of the entries in the My Phone Number(s) list will have been defined. You may not be able to change these predefined entries.

This option is also used as your account number for accessing the mobile internet.



Fixed Dialling

Availability of the Fixed Dialling menu depends on the type of SIM card.

This feature allows you to limit use (typically third-party use) of your phone to a predefined list of telephone numbers or, if you wish, to a list of country codes, area codes, or other prefixes of your choosing.

When Fixed Dialling is switched on, the only numbers that can be dialled from your phone are those stored (or whose prefix is stored) in the Fixed Dial list. If you attempt to dial any other number (apart from an emergency number), the message **Restricted** will be displayed.

To make a call when Fixed Dialling is switched on, either dial the number manually, or select it from the Fixed Dial list and press **OK**.

Up to 40 entries can be stored in the Fixed Dial list. The list is stored on your SIM card.

This option may be affected by the Call Barring setting.

View Fixed Dial List

This option allows you to scroll through the numbers in the Fixed Dial list. When you find the number you want, press **OK** to make the call.

Setup Fixed Dialling

This option allows you to switch Fixed Dialling on or off and to enter or change entries in the Fixed Dial list.

You will be prompted to enter your PIN2 security code when you select this option.

On

Switches fixed dialling on.

Off

Switches fixed dialling off.

Edit Entry

Modifies or clears an entry in the Fixed Dial list. When you select this option, the first non-empty location in the list will be displayed. Scroll to the entry you want to change and press **OK**. You will be prompted to edit the phone number and the name. To erase the entry, press **C**.

Add Entry

Adds a phone number and name to the Fixed Dial list. When you select this option you will be prompted to enter the phone number, name and a location number. If you do not specify a location number, it will be stored in the next available location.

When setting up your Fixed Dial list, you may want to reserve the first nine locations for phone numbers you wish to One-Touch Dial. See also 'One-Touch Dial Setting'.

Erase Entry

Erases a phone number and name from the Fixed Dial list. The first entry in the Fixed Dial list will be displayed. Scroll to the entry you wish to delete and press **OK**.



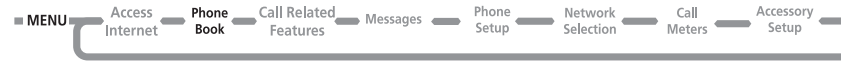

One-Touch Dial Setting

This option allows you to specify which Phone Book list can be One-Touch Dialed.

To SIM Card Memory

Switches One-Touch Dialling to your Personal Numbers list stored on your SIM card (locations 101 to 109).

To Fixed Dial list

 This option is only available if you have Fixed Dialling.

Switches One-Touch Dialling to your Fixed Dial list (locations 1 to 9).





Call Related Features Menu

Menu Navigation

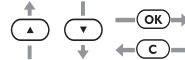

Items shown in *Italics* are available only when **Extended Menus** are switched on.
 † Availability depends on the type and settings of the SIM card and/or your subscription to these services.

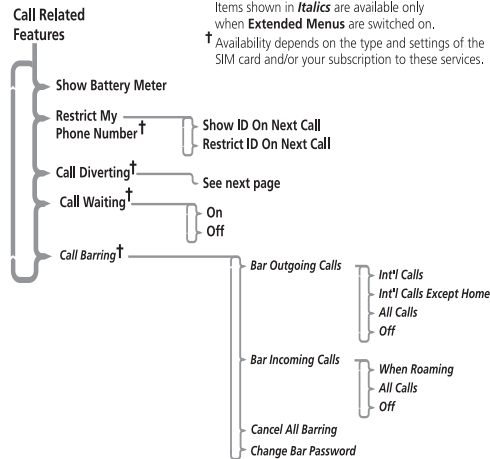

Show Battery Meter

This option displays the approximate amount of battery capacity remaining, for example:

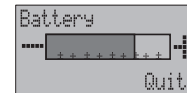

Number of Segments	Approximate Charge Level
1	less than 5% (recharging needed)
3	less than 20%
5	less than 60%
7	greater than 60%

Press (↑). Select the Quick Access feature (→ Battery Meter?).



Restrict My Phone Number

'Restrict My Phone Number' is a network feature. You will need to subscribe to one of the two Caller Line Identification restriction features with your Cellular Service Provider.

Show ID on Next Call

Your phone number is sent with the next attempted call, after this your phone number will not be sent until you re-select this option.

Restrict ID on Next Call

Press **↑**. Select the Quick Access feature (☞ Restrict My ID?).

Your phone number will not be sent with the next attempted call, after this your phone number will be sent with calls until you re-select this option.

OK Call Diverting

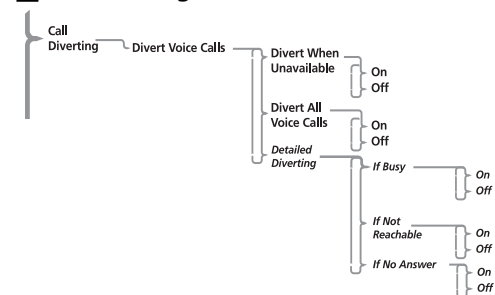

Call diverting is a network feature. If your phone is unavailable, or you do not wish to receive calls, incoming calls can be diverted to other phone numbers.

This option can be used to:

- Divert all incoming Voice calls unconditionally.
- Divert incoming Voice calls whenever your phone is unavailable, busy, not reachable or not answered.
- Reset all diversion options to off.

ⓘ You cannot change the call divert settings when you are out of network coverage.

After selecting any of the call divert options there will be a short delay while the phone asks the network for the current setting.



Divert Voice Calls

This option will allow you to set your phone to *Divert When Unavailable*, *Divert All Voice Calls* or *Detailed Diverting*.

Divert When Unavailable

This option will enable you to divert all incoming Voice calls to a single number, whenever your phone is unavailable.

The option has two settings, **On** or **Off**.

If you change the setting to **On**, you will be asked to enter a diversion phone number using the digit keys.

Setting "Divert When Unavailable" to **On** will have the same effect as setting all "Detailed Diverting" options to **On**.

When **On**, *Divert When Unavailable* takes priority over detailed diversion settings.

Divert All Voice Calls

Press **(1)**. Select the Quick Access feature (*Divert On/Off?*).

This option will enable you to *unconditionally* divert all incoming Voice calls to a single number.

The option has two settings, **On** or **Off**.

If you change the setting to **On**, you will be asked to enter a diversion phone number using the digit keys.

When **On**, *Divert All Voice Calls* takes priority over all other Voice call diversion settings.

Detailed Diverting

These options will enable you to divert Voice calls to different numbers, depending upon the current status of your phone.

Each of the following detailed diverting options operate in the same way.

Each option has two settings, **On** or **Off**.

If you change the setting to **On**, you will be asked to enter a diversion phone number using the digit keys.

Detailed diversion settings are ignored while *Divert All Voice Calls* or *Divert When Unavailable* are **On**.

If Busy

This option will divert incoming calls if your phone is busy.

If Not Reachable

This option will divert incoming calls if your phone cannot be contacted by the network.

If No Answer

This option will divert incoming calls if you do not answer the call.





OK Call Waiting

The Call Waiting menu item has two settings On or Off. If you select Off, you will be not be notified of waiting calls. The person trying to contact you will either receive the busy tone, or be diverted by the 'Detailed Diverting - If Busy' option.

If Call Waiting is On, you will be notified of a waiting call by an audible alert and by the message *Call Waiting - Answer?*. You can press the **OK** key to accept the waiting call, or use the **MENU** and then the **OK** key to scroll to an alternative option and then press **OK**.

If you have Caller Line Identification, the caller's number or name is displayed instead of the Call Waiting message.

Availability of this feature depends on your service provider.

OK Call Barring

Call barring is a network feature which can be used to selectively bar outgoing and incoming calls.

If you change the barring setting, you may be asked to enter your barring password. There will be a short delay while the phone notifies the network of the new setting. When the change has been made by the network, the phone will display a confirmation message.

The *initial* password will be supplied to you by your Cellular Service Provider when you subscribe to this service.

This option may be affected by the Fixed Dialling setting.

Bar Outgoing Calls

After selecting this option, there will be a short delay while the phone asks the network for the current setting.

Int'l Calls

When selected, this option will bar outgoing international calls.

Int'l Calls Except Home

When selected, this option will bar outgoing international calls, except those to your home country.

All Calls

When selected, this option will bar all outgoing calls, except emergency calls.

Off

When selected, this option will disable all call barring for outgoing calls.

Bar Incoming Calls

After selecting this option, there will be a short delay while the phone asks the network for the current setting.

When Roaming

When selected, this option will bar incoming calls when you are roaming.

You may wish to select this option, as some Cellular Service Providers charge an additional fee for receiving calls when you are roaming.

All Calls

When selected, this option will bar all incoming calls.



Off

When selected, this option will disable all call barring for incoming calls.

Cancel All Barring

This option can be used to set all Call Barring options to Off.

Change Bar Password

This option can be used to change the call barring password.

After selecting this option, you will be asked to enter the current password.

You will then be asked to enter, and then re-enter, your new, **4 digit**, barring password. When the change has been made by the network, the phone will display a confirmation message.





Messages Menu

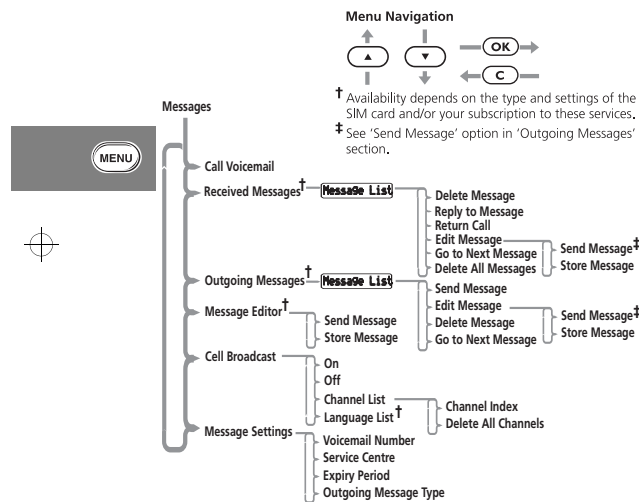

Your phone supports the two GSM message features: Short Message Services (SMS) and Cell Broadcast.

SMS Messages

These are text messages that are sent specifically to and from your phone number.

When an SMS message is received, your phone:

- 1 Makes three short alert tones.
- 2 Displays the (messages) icon.
- 3 Stores the message for later viewing, if there is space. If there is not enough space, the icon will flash. One or more messages must be removed before the message can be stored.

Your Cellular Service Provider will transmit a message for a limited amount of time. If a memory location is not made available before the message is removed from the network, then you will not be able to receive or read it.

- 4 Message will then be displayed with the prompt; Read Now?
- 5 If **OK** is pressed, the phone will enter the Received Messages browser and immediately display the new message.
- 6 If **C** is pressed the phone will return to the screen which was displayed prior to receipt of the message.
- 7 If any other key is pressed it will perform the function linked with that key.
- 8 If no key is pressed the display will time-out after 1 minute and return to the screen which was displayed prior to receipt of the message.



Cell Broadcast Messages

These are general messages that your service provider broadcasts to all phones in a geographic area. Your phone can only receive a cell broadcast message when it is in idle mode.

The messages are broadcast in numbered 'channels'. For example, channel 050 might be for local weather, traffic reports or stock market prices. Please contact your service provider for a list of available channels and the information they provide.

While a broadcast message is scrolling across the display, you can stop and start it by pressing **(*)**. Press **(#)** to restart the message from the beginning. If you want to remove the message from the display, press **(C)**.

ⓘ If you need to use the **(*)** and **(#)** keys for their normal functions while you are receiving a cell broadcast message, you must first remove the message.

When the message has scrolled across the display, the beginning of the message remains until one of the following occurs: you remove it; a new message arrives; or you leave the geographic area. For set up details, see **Cell Broadcast**.

How to Read SMS Messages

You can use the scroll key (**(▲)** or **(▼)**) to scroll through messages in either the Received Messages or Outgoing Messages lists.

To display a specific message, enter the message number, for example press **(5)** to display the 5th message. If the message does not exist, **Invalid Message Number** will be displayed.

Alternatively, to display the next message, press **(OK)** and select **Go To Next Message**.

How to Create and Edit SMS Messages

Use the *Message Editor* to create or modify text messages. When you enter the editor, the last message that was edited will be displayed. Press and hold **(C)** to clear the message and start a new one, or modify the message displayed. For an explanation of how to enter text, see 'How to Enter Alphabetic Characters'.

Press **(OK)** once you have completed your message. You will then be presented with the following options:

Send Message - If you select this option you will be prompted for a phone number, enter the number and then press **(OK)** to send the message.

Store Message - Select this option to store your edited message in your Outgoing Messages list.

ⓘ If you don't store the message after it has been edited, you will lose all your changes as soon as you select another message to be edited.





OK Call Voicemail

Press **(↑)**. Select the Quick Access feature (Call Voicemail?).

This option will make a call to the current voicemail number. You can also press **(☎)** to call the Voicemail number. The voicemail number is entered using the 'Voicemail Number' option in the Message Settings menu.

OK Received Messages

Press **(↑)**. Select the Quick Access feature (Read Messages?).

This option is used to view and manage any SMS messages that have been sent to your phone number.

When selected, this option will display a message indicating the total number of messages and how many of these are new. If there are no messages **No Messages** will be displayed.

If there are messages, the new messages will be displayed first, followed by the old. Repeated presses of the **(◀)** key will display the whole message, when it was sent and the phone number who sent it (if available).

Once you have read a new message it will automatically become old.

See 'How to Read SMS Messages' for more information on navigating through the messages.

Press the **(OK)** key, when viewing any message, to enter the sub-menu.

Delete Message

This option will delete the currently viewed message.

Reply to Message

This option allows you to reply with a message.

Return Call

This option can be used to call the person who sent you the message, if their number has been included by the network, or a number that has been included in quotes " " in the message.

Edit Message

This option allows you to use the Message Editor to edit the selected message and then to either send the modified message and/or store it in your Outgoing Messages list. See 'How to Create and Edit SMS Messages' for more information on using the Message Editor.

Go to Next Message

This option will display the next received message.

If you are currently reading the last message in your list then this option will take you back to the top of the list.

Delete All Messages

This option allows you to delete all received messages whether they have been read or not.

Once deleted, messages are NOT retrievable.



Outgoing Messages

Press **(↑)**. Select the Quick Access feature (Outgoing SMS?).

This option is used to view and manage any outgoing messages. These messages will be stored on your SIM card. When you select this option, the total number of messages will be displayed followed by the first message in the list.

You cannot send an outgoing message until the Message Service Centre number has been set. See 'Message Settings'.

Press the **(OK)** key, when viewing any message, to enter the sub-menu. See 'How to Read SMS Messages' for more information on navigating through the messages.

Send Message

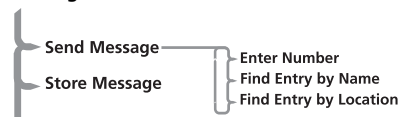

This option allows you to add the destination phone number using a sub-menu. Using the scroll keys you can select:

Enter Number - this allows you to manually enter the phone number using the keypad and send the message.

Find Entry by Name - this allows you to recall a phone number from the Phone Book by name and send the message (see 'Find Entry by Name' in the 'Phone Book' section).

Find Entry by Location - this allows you to recall a phone number from the Phone Book by location and send the message (see 'Find Entry by Location' in the 'Phone Book' section).

Edit Message

This option allows you to use the Message Editor to edit the selected message and then to either send the modified message or store it in your Outgoing Messages list. See 'How to Create and Edit SMS Messages' for more information on using the Message Editor.

Delete Message

This option will delete the currently viewed message.

Go to Next Message

This option will display the next outgoing message.

Message Editor

Press **(↑)**. Select the Quick Access feature (Message Editor?).

The Message Editor is used to edit the currently selected message and then to either send the modified message or store it in your Outgoing Messages list. See 'How to Create and Edit SMS Messages' for more information on using the Message Editor.





Cell Broadcast

This option determines the cell broadcast settings. See also **Cell Broadcast Messages**.

On

Select **On** to receive cell broadcast messages. You must then use **Channel List** to specify the appropriate channels.

Off

When you select **Off**, you do not receive any cell broadcast messages and you automatically delete all existing cell broadcast messages.

Channel List

Select either **Channel Index** or **Delete All Channels**.

Channel Index

This option allows you to select up to five different channels for receiving cell broadcast messages. If you modify a channel, you also remove any message associated with it.

Use **▲** or **▼** to highlight the channel index you require (1-5) and then press **OK**. The phone prompts you to **Enter Channel**.

Type in the channel number and press **OK**. The phone stores the channel details and returns you to the channel index list.

Please contact your service provider for a list of available channels and the information they provide.

Delete All Channels

This option deletes all the channels and all the existing messages.

Language List

 Availability depends on the type and settings of the SIM card, and/or your subscription to this feature where available.

This option allows you to select different languages for Cell Broadcast message. See also **Language Selection** in the **Phone Setup Menu**.

Message Settings

Voicemail Number

This option is used to enter a phone number which will be used by the 'Call Voicemail' option.

If there is already a Voicemail Number, this will be shown in the display. This can be used, modified or deleted as desired.

Service Centre

Before you can send any messages you must use this option to enter your Message Service Centre number. This number is obtained from your Cellular Service Provider.

If there is already a Message Service Centre number, this will be shown in the display. This can be used, modified or deleted as desired.

MENU



Expiry Period

You can use this option to specify the maximum time, in hours, that your unforwarded messages are to remain with the Message Service Centre before being deleted. When you select this option, the current expiry period will be displayed (the default is 24 hours).

The maximum value you can enter is 10584, though the real limit will depend on your Message Service Centre.

Outgoing Message Type

This option is network dependent and can be used to specify the format of your outgoing messages. You can select from the following message types: Text (default), Fax, X400, Paging, E-Mail, ERMES or Voice.

 You do not need to select Voice to send messages to Voicemail boxes.





Phone Setup Menu

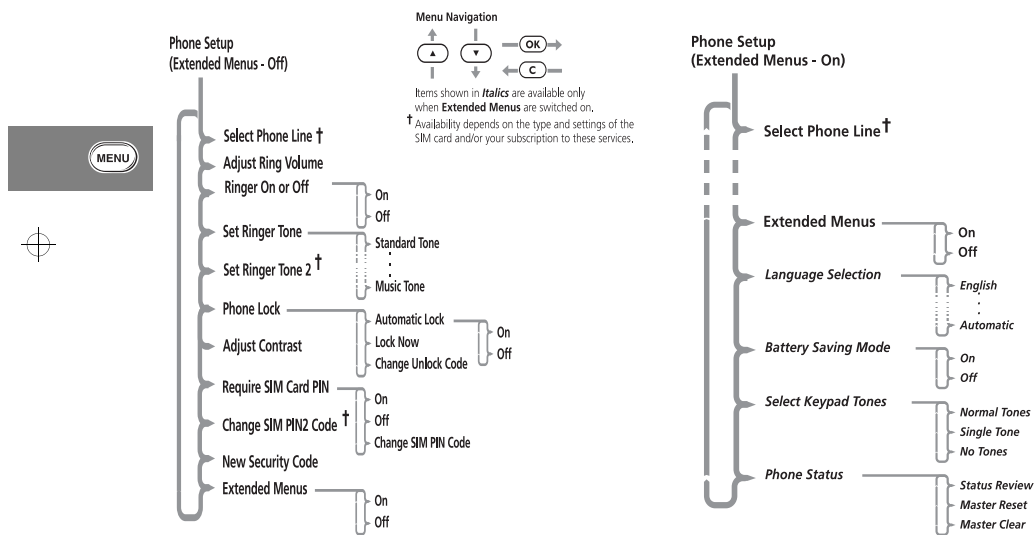



Select Phone Line

Press (↑). Select the Quick Access feature (Switch Line 1/2?).

This option allows you to switch between Line 1 and Line 2.

Availability depends on the type and settings of the SIM card, and/or your subscription to this feature.

This feature is not available when you are using the GSM 900 band.

Adjust Ring Volume

This option is used to set the incoming call ring tone volume.

The volume will be displayed as follows:



Adjust the volume by pressing the volume buttons on the side of your phone.

Press (↑) followed by the volume button to either increase or decrease the ringer volume.

Ringer On or Off

Sets incoming call alert to either a ringer tone or a display message.

OK Set Ringer Tone

This option sets the tone your phone will make when an incoming call is received on Line 1.

Standard Tone

Your phone makes a standard ringing tone.

Single Ring Tone ... Music Tone

When selected, your phone will produce one of these alternative ringer tones.

If you select the Single Ring Tone option, the phone will only ring once when a call is received.



OK Set Ringer Tone 2

This option sets the tone your phone will make when an incoming call is received on Line 2.

This option will not appear if you do not subscribe to Line 2.

OK Phone Lock

Press (↑). Select the Quick Access feature (Lock Now?).

This option is used to set, and change, the unlock code.

The unlock code can be set to protect your phone from unauthorised use. It can be set to automatically lock your phone each time it is switched on.

The unlock code is a four digit number which is set at manufacture to **1234**. This can be changed at any time by using the 'change unlock code' option.



Automatic Lock

This option can be used to automatically lock your phone each time it is switched on. The option has two settings, On or Off.

Lock Now

This option can be used to immediately lock your phone. Once selected, your phone will be unusable until the unlock code is entered.

Change Unlock Code

This option is used to change the unlock code.

After selecting this option, you will be asked to enter the current security code before you can proceed.

You can now enter a four digit code to replace the old code.

*By pressing the **MENU** key, you can access this option even when the phone is locked.*

Adjust Contrast

*Press **↑**. Select the Quick Access feature (**●** Adjust Contrast).*

This option is used to adjust the screen contrast. The contrast is displayed as follows:

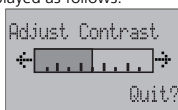

Adjust the contrast by pressing **←*** or ***→** on the keypad.

Pressing **OK** or **C** on the keypad will end the contrast adjustment.

Require SIM Card PIN

This option is used to set, and change, the PIN code.

The PIN code can be set to protect your SIM card from unauthorised use. If set to On, access to your SIM card will be restricted each time it is inserted or the phone is turned on.

The option has two settings, On or Off.

If the SIM card does not support PIN code disabling, these items will not appear.

Change SIM PIN Code

This option is used to change the SIM card PIN code.

The 'Require SIM Card PIN' option must be set to On and you must enter the old PIN code before you can proceed.

You will be asked to enter a new, four to eight digit code to replace the old PIN code. The new PIN code must be entered again as confirmation.

If the PIN number is entered incorrectly three times in a row, your SIM card will automatically lock-up and the Blocked message will be displayed.





Unlocking Your Phone

If you receive the Blocked message you will need to enter an unblock code and key sequence before you can use the phone.

The 8 digit PIN unblocking code will have been provided with your SIM card by your Cellular Service Provider.

Enter the following key sequence to unblock your phone:

The new PIN code must contain four to eight digits.

If this operation is performed incorrectly 10 times in a row, your SIM card will become permanently blocked.

Change SIM PIN2 Code

This option is used to change your PIN2 security code.

When you select this option you must enter the old PIN2 security code before you can proceed.

You will be asked to enter a new, four to eight digit code to replace the old PIN2 security code. The new PIN2 security code must be entered again as confirmation.

If the PIN2 security code is entered incorrectly three times in a row, the Blocked message will be displayed.

When the Blocked message is displayed, you are not allowed access to menu items that require you to enter the PIN2 code, for example 'Setup Fixed Dialling' and 'Call Charge Settings'.

If you receive the Blocked message when you try to enter your PIN2 code, you will need to unblock and change the code using the following key sequence:

The 8-digit unblocking code will have been provided with your SIM card by your Cellular Service Provider.

If the PIN2 unblocking operation is performed incorrectly 10 times in a row, your PIN2 code will become permanently blocked.

New Security Code

The security code is used to control access to security and other options within the menus.

This option is used to change the security code, which is set at manufacture to **000000**.

Once selected, you will be asked to enter the current security code before you can proceed.

You will then be asked to enter a new, six digit code to replace the old security code.

In order to safeguard your phone, you should change your security code from the factory setting as soon as possible.





OK Extended Menus

 Press and hold **MENU**. *Extended Menus will be temporarily activated until you exit the Options menu.*

This option is used to switch the extended menus on or off. If the extended menu option is switched off, you will not be able to access any of the extended features. The option has two settings, **On** or **Off**.

OK Language Selection

This option is used to change the language for display messages. The option has multiple settings. When you select a language, all further display prompts and help messages will be in the selected language.

Battery Saving Mode

This option can help you to conserve battery power by activating DTX (Discontinuous Transmission), and deactivating the backlight for incoming Cell Broadcast messages. The option has two settings, **On** or **Off**.

OK Select Keypad Tones

This option allows you to change or disable tones you hear when you press a key. The option has three settings, **Normal Tones**, **Single Tone** or **No Tones**.



MENU



Phone Status

Status Review

This option can be used to view the current setting of menu options.

When selected, your phone will display a list of menu items which have been changed from the default setting. Press the **MENU** key to view the next item.

Master Reset

This option should be used with caution.

This option is used to restore certain phone options to their original settings.

When selected, you will be asked to enter the security code. Once entered, the master reset option will perform the following operations:

- Cancel Automatic Answer, Audible Call Timers, In-Call Display Meter, Battery Save (DTX), Automatic Lock and Cell Broadcast.
- Return Language Selection to Original.
- Restore Keypad Tones to Normal, Ringer Tones to Standard, SMS Alert Tones to Standard, Volume Level to Medium and Network Search frequency to Medium.
- Restore Extended Menus to their default settings.
- Return the band selection to the default setting.

Master Clear

This option should be used with extreme caution.

This option is used to restore certain phone options to their original settings.

When selected, you will be asked to enter the security code. Once entered, the master clear option will perform the same operations as 'Master Reset', plus the following operations:

- Clear the Last Calls Made and Last Calls received list
- Clear the Message Editor
- Reset the Resettable Call Timers.

Master Clear does **not** clear the:

- Fixed Dial list
- My Number(s) list
- Charge Meters
- Received and Outgoing Messages list
- Voicemail number
- SMS Service Centre number
- Lifetime timer.



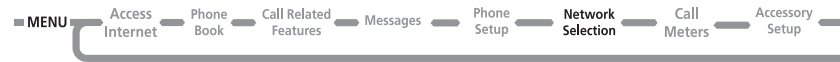

Network Selection Menu

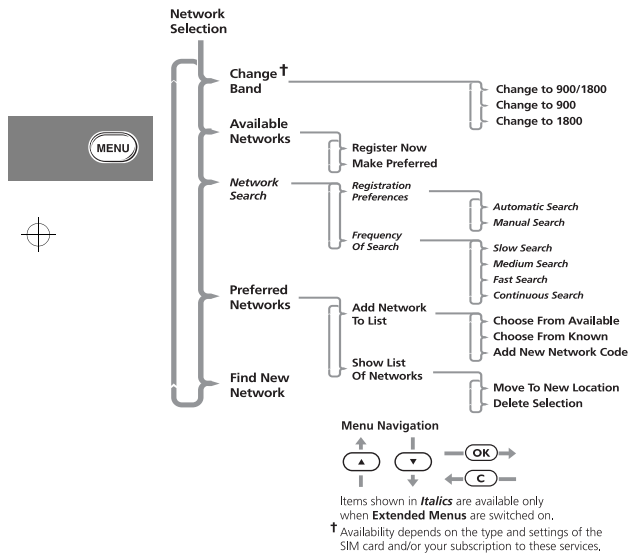

Network Selection

In order for the phone to make and receive phone calls, it must register with one of the available networks. The phone can handle any of the following types of network: GSM 900, GSM 1800 and combined GSM 900/1800.

Your phone automatically searches for the last network used. If, for any reason, this network is unavailable, your phone will attempt to register with a new network.

When your phone needs to register with a new network, it will generate a sorted list of networks. The network list is sorted in the following order:

- The Home network.
- Networks from a preferred list.
- A random list of other networks found above a certain signal strength.

Any forbidden networks, stored in the SIM card, will not be included in the sorted list.



Change Band

Press **(↑)**. Select the Quick Access feature (**Ⓜ** Change Band?).

ⓘ Network and subscription dependent feature. Not available in all areas.

The country where you purchased your phone determines the default band that it uses. When you travel abroad, you must remember to change to an appropriate band.

Use this option to change the band of operation for your phone.

The country where you purchased your phone also determines which of the following options are available:

- GSM 900/1800 (referred to as 900/1800)
- GSM 900 (referred to as 900)
- GSM 1800 (referred to as 1800)

When you select Change Band, your phone prompts you to View Options?. Press **(OK)** and then use the **(↓)** key to scroll through the options. Press **(OK)** to select the band you require.

When you select a new band, your phone displays the confirmation message Changed to XXXX, and then automatically searches all the available networks.

Your phone then attempts to register with a preferred network within the selected band.

If you re-select the currently selected band, the confirmation message still appears but the band is not changed and the phone does not attempt to register with any other network.

ⓘ You cannot change bands during a call. If you attempt to change bands during a call, your phone displays Can't Access Network and then returns to the in-call display.

Available Networks

When selected, this option will scan to see which networks are operating in your current location. When the scan is complete, press the **(↓)** key to scroll through the list. When you see a network you wish to register with or store in your preferred list, press the **(OK)** key. You will now enter the 'Register Now' and 'Make Preferred' sub-menu.

Register Now

Once selected, your phone will try to register with the selected network. If the registration fails, your phone will try to register in the normal way.

Make Preferred

Once selected, you will be asked where the selected network is to be located in the preferred list.

Network Search

These options determine how often your phone tries to register with a network and how the attempt is made.

Registration Preferences

This option determines how the phone tries to register with a network.

The option has two settings, Automatic Search or Manual Search.





Automatic Search Mode

In the automatic mode, the phone will try to register with the first network in the sorted list. If this is successful, your phone will display the network name and then enter the standby mode.

If registration is unsuccessful with one network in the list, your phone will try the next listed network. If your phone fails to register with any of the listed networks, it will start at the beginning of the list after a preset period. The preset period is determined by the 'Frequency Of Search' option.

Manual Search Mode

In the manual mode, the phone will present you with the sorted list of networks. Use the **▼** and **OK** keys to select one network from the list. Your phone will try to register with the selected network. If this is successful, the phone will display the network name and then enter the standby mode.

If registration is unsuccessful, your phone will present the list again after a preset period. The preset period is determined by the 'Frequency Of Search' option.

Frequency of Search

This option is used to determine how long your phone waits before attempting to re-register after a registration attempt has failed.

The option has the following settings: Slow Search, Medium Search, Fast Search or Continuous Search.

! *Fast and Continuous Search may use up a significant amount of battery power.*

OK Preferred Networks

Add Network to List

This option enables you to add networks to your preferred list.

When selected, the 'Choose From Available' option will scan to see which networks are operating in your current location. When the scan is complete, press the **▼** key to scroll through the list. When you see a network you wish to store in your preferred list, press the **OK** key. You will be asked where the selected network is to be located in the preferred list.

The 'Choose From Known' option will, when selected, present you with a preset list of networks. Press the **▼** key to scroll through the list. When you see a network you wish to store in your preferred list, press the **OK** key. You will be asked where the selected network is to be located in the preferred list.

Select the 'Add New Network Code' option to enter network codes directly. Once entered, you will be asked where the network is to be located in the preferred list.

Show List of Networks

This option is used to display the networks you have stored in your preferred list. In addition, pressing the **OK** key will select the currently displayed entry and enter a move/delete sub-menu.



When 'Move to New Location' is selected you will be asked to enter a new location for the selected network.

When selected, 'Delete Selection' will remove the selected network from the preferred list.

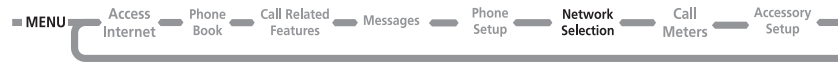
MENU



Find New Network

 Press . Select the Quick Access feature ( Find New Network?).

When selected, the phone will try to register with a network in the normal manner, with one exception. When the registration attempt is made, your current network will be excluded from the list of those available. If the attempt fails, your phone will then try to re-register with the previous network.





Call Meters Menu

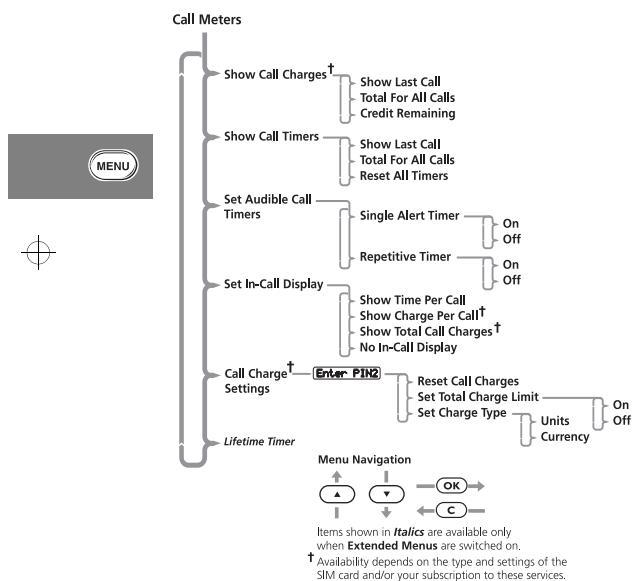

Call Metering

Your phone has an internal metering system which can be used to provide you with individual and total call times or costs.

Call cost information is only available if you receive the Advice of Charge service. If you do not receive this service, then only time meters are available.

The meter can be displayed during a phone call and audible tones can be generated to indicate the passage of call time.

Your phone can handle values up to 21 digits long, although during calls it can only display the last 12 digits. If the value exceeds 21 digits, then **Too Large** is displayed.

In addition, you can set a maximum charge limit so that your phone will monitor either the number of units used or the call cost, and then not allow the limit to be exceeded.

Show Call Charges

This feature allows you to display the cost of your calls or the amount of credit remaining. The figures are in phone units or currency depending on the setting of the **Set Charge Type** option.

Show Call Charges is only available if you receive the Advice of Charge service.



Show Last Call

Press . Select the Quick Access feature (Call Charge?).

Displays the cost of your last chargeable call.

Total For All Calls

Displays the cost of all your chargeable calls since the charge meters were reset to zero using the 'Reset Call Charges' option.

Credit Remaining

Press . Select the Quick Access feature (Show Credit?).

Displays the difference between your total call costs and the limit specified by the 'Set Total Charge Limit' option. If there is no limit, No Charge Limit Set will be displayed.

Show Call Timers

This feature allows you to display the duration of your calls and to reset your time meters to zero.

If you receive the Advice of Charge service then all calls are timed. If you do not receive the Advice of Charge service then, depending on the model, either all calls or only outgoing calls are timed.

Show Last Call

Press . Select the Quick Access feature (Call Timer?).

Displays the duration of your last call.

Total For All Calls

Displays the duration of all your calls since the time meter was reset to zero using the 'Reset All Timers' option.

Reset All Timers

Sets the resettable time meters to zero. The Lifetime Meter is not resettable.

OK Set Audible Call Timers

Your phone provides two programmable audible call timers:

- The 'Single Alert Timer' will sound a beep just once during a call, after a preset time has elapsed.
- The 'Repetitive Timer' will sound regular beeps during a call, at preset intervals.

In both cases, the timers will sound their beeps ten seconds before the end of the programmed time.

Set In-Call Display

This feature allows you to specify whether the time or charge meters are displayed during a call. If you do not have the Advice of Charge service, then only the time meter is available.

If a total charge limit has been set, then the in-call display always shows your remaining credit.





Show Time Per Call

This option is used to display the time meter during calls. If you receive the Advice of Charge service, only the chargeable calls will be displayed.

Show Charge Per Call, Show Total Call Charges

These menu items are only available if you receive the Advice of Charge service.

These options are used to display the call charges meter during and after chargeable calls. The meter shows phone units or currency depending on the setting of the 'Set Charge Type' option.

No In-Call Display

This option switches off in-call display of the charge/time meter.

Call Charge Settings

This feature allows you to customise your Advice of Charge settings. You will be prompted to enter your PIN2 security code before you can access the options.

This menu item is only available if you receive the Advice of Charge service.

Reset Call Charges

This option resets your charge meters to zero.

Set Total Charge Limit

This option sets the maximum limit for call charges; once this limit has been reached, the network will refuse any further chargeable calls.

If you switch the charge limit On, you will be prompted to enter a new limit. Enter the amount as either units or currency depending on the setting of the Set Charge Type option. Units must be entered as whole numbers.

Once a limit is set, the in-call display will show the remaining credit. When you reach your last two minutes, the warning message **Approaching Charge Limit** will be displayed and a warning alert will sound. The sound will be repeated when one minute remains. When the limit is reached the message **Charge Limit Reached** will be displayed and you will not be able to make any more chargeable calls.

Once the limit is reached the Total Charge Limit will need to be reset or switched off before any chargeable calls can be made. Select **Off** to switch off the charge limit.

MENU



Accessory Setup Menu

Your phone can also be linked to external microphones and speakers for handsfree operation.

OK Automatic Answer

This option allows your phone to automatically answer an incoming call after two rings.

This option has two settings, **On** or **Off**.



Accessory Setup



Menu Navigation



† Only this option will be displayed when the headset accessory is attached.



Using the Quick Access Menu

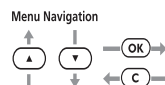
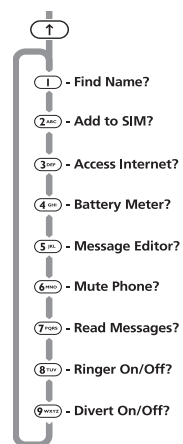

 The menu shown above represents the default setting supplied with your phone.

Although the features in your phone are available through easy access menus, some of the most commonly used features are also available in the Quick Access menu. Each feature in the menu is allocated a number from 1 to 9.

To use a Quick Access feature, press the quick access key (↑) followed by the number of the feature, or press (←) or (→) to scroll through the menu and then press (OK).

You can change the features, and the positions of the features, available in the Quick Access menu - see 'Customising the Quick Access Menu'.

Each Quick Access feature is represented by an icon as well as the feature name. The currently selected icon is shown with a dark background.

Find Name?

You will be prompted to Enter Name. Enter the first three characters of the name and press (OK). The first matching entry in the Phone Book will be displayed. Press (OK) to call the number.

Find Location?

You will be prompted to Enter Location. Enter the location number and press (OK). The first matching entry in the Phone Book will be displayed. Press (OK) to call the number.



 **Add to SIM?**

You will be prompted to enter a phone number and then a name.

 *If you already had a number displayed, it will automatically be re-displayed when you select this feature.*

The number will be stored in the next available SIM card location. See 'Add Entry' for more information.

 **Access Internet?**

 *This is a network and subscription dependent feature. Contact your service provider for details about the mobile internet services based on the WAP (Wireless Application Protocol) technology that they provide.*

Use this option to start your mobile internet session. See **Access Internet** for more information.

 **Battery Meter?**

A bar graph indicating the approximate battery charge level will be displayed. The more bars displayed, the greater the charge level.

See 'Show Battery Meter' for more information.

 **Lock Now?**

Immediately locks your phone, you will not be able to use your phone until the unlock code is entered. See 'Phone Lock' for more information.

 **Mute Phone?**

Temporarily turns the microphone off during a phone call. Reselect this option to resume your conversation.

 **Adjust Ring?**

This option is used to display and to set the incoming call ring tone volume.

 **Ringer On/Off?**

This option allows you to turn off your phone's ringer.

 **Read Messages?**

Your newest message will be displayed; you can then read, delete and edit messages as normal. See 'Received Messages' for more information.

 **Outgoing SMS?**

Your newest message will be displayed; you can then read, send, delete and edit messages as normal. See 'Outgoing Messages' for more information.

 **Message Editor?**

The last message that was edited will be displayed. Press and hold  to clear the message and start a new one, or modify the message displayed. See 'How to Create and Edit SMS Messages' for more information.

 **Received Calls?**

Displays the first entry in the Last Calls Received list. You can scroll through the list and call the numbers as normal. See 'Last Calls Received' for more information.

 **Call Charge?**

Displays the cost of your last chargeable call. See 'Show Call Charges' for more information.

 **Call Timer?**

Displays the duration of your last chargeable call. See 'Show Call Timers' for more information.

 **Show Credit?**

Allows you to quickly display the Credit Remaining.

 *This will only show the credit remaining if you receive the Advice of Charge service.*

 **Restrict My ID?**

Your phone number will not be sent with the next attempted call; after this your phone number will be sent until you reselect this option.

 **Find New Network?**

Allows you to quickly search for a new network.

 **Adjust Contrast**

Allows you to adjust the screen contrast.

 **Divert On/Off?**

Unconditional voice call diversion will be switched either on or off depending on the current setting.

 *You must have defined a diversion number using the 'Divert All Voice Calls' option in the Call Diverting menu in order to use this feature.*

 *You cannot switch call diverting on or off if you are outside network coverage.*

 **Change Band?**

Use this option to change the band of operation for your phone. See **Network Selection Menu** for more information.

 **Call Voicemail?**

Your phone will make a call to your voicemail number.

 *You must have defined a Voicemail number in order to use this feature.*

See 'Call Voicemail' for more information.

 **My Motorola?**

Use this option to start your mobile internet session and access the *MyMotorola.com*¹ web site. See **Access Internet** for more information.



1. Availability depends on the type and settings of the SIM card, and/or your subscription to these features.

Customising the Quick Access Menu

You can change the features in the Quick Access menu to suit your personal preferences.

To customise the menu:

- 1 Press **(↑)** and scroll to the menu item you wish to change.
- 2 Press and hold **(OK)** to access the list of features available. The currently selected feature will be displayed.
- 3 Scroll through the list until you find the feature you wish to store in the Quick Access menu; press **(OK)**.
- 4 **Completed** will be displayed to confirm that the feature has been stored.

The items in the Quick Access list will appear in the following order:

- Find by Name
- Find by Location
- Add Entry to SIM
- Access Internet
- Battery Meter
- Phone Lock Now
- Phone Mute On or Off
- Ring Volume
- Ringer On or Off
- Read Messages
- Outgoing Messages
- Message Editor

- Last Calls Received
- Last Call Charge
- Last Call Timer
- Credit Remaining
- Restrict My ID
- Find New Network
- Adjust Contrast
- Divert Voice Call
- Change Band
- Call Voicemail
- My Motorola



Accessories

The following accessories have been designed to work with your phone. Additional accessories may be available and are packaged separately. Please refer to your local service provider or retail outlet for more information.

 *The use of wireless devices and their accessories ("devices") may be prohibited or restricted in certain areas. Always obey the laws and regulations on the use of these devices.*

 *Please ensure that when using any external connector with your phone that you are certain that it is fully inserted.*

Travel Charger

The Power Adapter (charger) connects the phone to a standard wall outlet. When connected directly to the phone, it charges the battery.

Vehicular Power Adapter

The Vehicular Power Adapter connects to your phone and allows you to charge your phone's battery while driving.

Personal Handsfree System

The Personal Handsfree System allows you to use your phone handsfree.

Belt Clip

The Belt Clip holds the phone while being worn on your belt.

 *The belt clip has been designed for your convenience and is not meant to secure your phone under all circumstances.*

Headset

The convenient headset provides both an earphone and microphone in one small accessory for simple handsfree and private telephone conversations. The headset plugs directly into the jack on the top left side of your phone, so that you can wear your phone and move freely.

Stereo Headset

The dual earpiece stereo headset and microphone allows for simple handsfree and private conversations. The earpieces are individually marked with an "R" on the right earpiece (marked red) and an "L" on the left earpiece (marked blue). The headset plugs directly into the jack on the top left side of your phone, so that you can wear your phone and move freely.







What to do if...

You can't switch your phone on	<p>Check the battery. Is it charged, properly fitted and are the contacts clean and dry? See 'Important Battery Information'.</p>
You can't make calls	<p>Check the signal strength meter in the display. If the signal is weak, move to an open space or, if you are in a building, move closer to a window.</p> <p>Check that your phone is switched on.</p> <p>Check the Network Selection settings. Try Manual Selection, or try another network. See 'Network Search'. Network and subscription dependent feature. Not available in all areas.</p> <p>Check your Operator coverage map.</p> <p>Is Restricted displayed? Check the Call Barring and Fixed Dialling settings.</p> <p>Has the call charge limit been reached? Use your PIN2 code to reset the limit or contact your Service Provider. See 'Set Total Charge Limit'.</p> <p>Has a new SIM card been inserted? Check that no new restrictions have been imposed.</p>
You can't receive calls	<p>Check the signal strength meter in the display. If the signal is weak, move to an open space or, if you are in a building, move closer to a window.</p> <p>Check the Call Diversion and Call Barring settings.</p> <p>Check the Ringer settings. If it is off, there is no audible alert. See 'Ringer On or Off'.</p>
You can't receive calls through your stereo headset	<p>Check your connections and ensure that they are inserted fully. The incoming call alert will only be sent to the red or right earpiece on the stereo headset accessory.</p>
Your phone won't unlock	<p>Have you inserted a new SIM card? Enter the new PIN code. See 'Entering Your SIM Card PIN Code'.</p> <p>Do you have a replacement phone? Enter the default phone unlock code - 1234.</p> <p>Have you forgotten the unlock code? Press MENU to change the unlock code (you will need your security code).</p>
Your PIN is blocked	<p>Enter the PIN unblocking code supplied with your SIM card (see 'Unlocking Your Phone').</p>
Your PIN2 is blocked	<p>Enter the PIN2 unblocking code supplied with your SIM card (see 'Change SIM PIN2 Code').</p>



Your SIM card won't work	<p><i>Is the card inserted the right way round? See 'SIM Card Insertion/Removal'.</i></p> <p><i>Is the gold chip visibly damaged or scratched? Return the card to your Service Provider.</i></p> <p><i>Check the SIM contacts. If they are dirty, clean them with an antistatic cloth.</i></p>
The battery won't charge	<p><i>Check the alignment of the batteries to ensure that they are installed properly. Make sure that the positive (+) and negative (-) marks on the batteries match the markings on the phone.</i></p> <p><i>Check the charger. Is it properly connected? Is it fully inserted? Are its contacts clean and dry? The phone should provide a beep-tone and the display should read "Charging Battery" within two minutes from the transformer being installed. See 'Your Battery'.</i></p> <p><i>Check the battery contacts. Are they clean and dry?</i></p> <p><i>Check the battery temperature. If it is warm, let it cool before recharging.</i></p> <p><i>Is it an old battery? Battery performance will decline after several years use. Replace the battery.</i></p> <p><i>Are you using a Motorola original battery? See 'Your Battery'.</i></p>
The battery drains faster than normal	<p><i>Are you in an area of variable coverage? This uses extra battery power.</i></p> <p><i>Is it a new battery? A new battery will need two to three charge/discharge cycles to attain normal performance. See 'Charging a New Battery'.</i></p> <p><i>Is it an old battery? Battery performance will decline after several years use. Replace the battery.</i></p> <p><i>Is it a battery that hasn't been completely discharged? Allow the battery to fully discharge (until the phone turns itself off) and then charge the battery overnight.</i></p> <p><i>Check that the Frequency Of Search feature in the Network Selection menu has not been set to Fast or Continuous. See 'Network Search'.</i></p> <p><i>Check that the Battery Saving Mode feature has not been set to Off.</i></p> <p><i>Are you using your phone in extreme temperatures? At extreme hot or cold temperatures, battery performance is significantly reduced.</i></p>
You can't cancel Call Diverting or Call Barring	<p><i>Wait until you are in an area with good network coverage and try again.</i></p>
The  symbol is flashing	<p><i>There is not enough memory available to store another SMS message. Use the Messages menu to delete one or more existing messages.</i></p>



You can't make international calls	<i>Some Service Providers automatically bar the ability to make international calls. Contact your Service Provider. Have you included the relevant codes? Press and hold the  key to display the international dialling prefix (+) and then enter the appropriate country code followed by the phone number.</i>
Your Personal Handsfree System is not operating properly	<i>Check all of the connections and make sure that they are inserted correctly. Check the connections to make sure that they are fully inserted.</i>





Index

A		C	
Access Internet	34	Call charge settings	70
Accessories	77	Call diverting	48, 75
Accessory setup menu	72	Call holding	28
Add entry		Call metering	68
To SIM card memory	42, 74	Call meters menu	68
Adjust Contrast	60	Call related features menu	47
Adjust ring volume	59	Call timers	69
Automatic answer	72	Call Transfer	31
Automatic lock	60	Call Voicemail	54
Automatic redial	24	Call waiting	28
Available networks	65	Calling a number	24
		Cancel all diverting	75
B		Capacity	43
Bar incoming calls	50	Checking battery capacity	47
Bar outgoing calls	50	Cell broadcast	56
Batteries		Battery saving mode	62
Charging	17	Messages	53
Installing the Batteries	17	Change band	65, 75
Low battery warning	20	From the default	
Maintaining	18	(900/1800)	65, 75
Removing	18	Change bar password	51
Battery charge indicator	16	Change SIM PIN2 code	61
Battery meter	47, 74	Change unlock code	60
Battery saving mode	62	Characters	41
Blocked message	23, 61	Charge meters	
Buttons		Resetting	70
Volume	15	Check capacity	43
		Conference Call	28
		Call Waiting	31
		End Active And Held	28
		Hold Call	27
		Make a New Call	27
		Reconnect	28
		Reconnect Held Call	28
		Restrict My Number	27
		Split Call	28
		Switch Calls	28
		Contrast	
		Adjust Contrast	60
		D	
		Delete	
		Last ten calls	44
		Message	54, 55
		Phone book entries	42
		Detailed diverting	49
		Dialling phone book numbers	25
		Display	16
		Display characters	41
		Displaying your own phone	
		number	44
		DTX	62



E

Earpiece connector 16
 Editing messages 53
 Emergency calls 25
 Ending a phone call 26
 Entering characters 40
 Erase name and number 42
 Extended menus 5, 62

F

Fault finding 79
 Find entry by location 42, 73
 Find entry by name 41, 73
 Find new network 67
 Fixed dialling 45
 Calling numbers 45
 Setting 45

H

Hold Call 27

I

In use symbol 16
 Initiating Transfer Call 31
 Installing the Batteries 17
 International phone calls 25
 Internet
 Accessing 34
 Internet service alerts 37



L

Language selection 62
 Last Calls Received 44
 Last ten calls 43, 74
 Lifetime timer 71
 Lock now 60, 74
 Locking the keypad 23
 Low battery warning 20

M

Making a phone call 24
 Master clear 63
 Master reset 63
 Menu
 Access Internet 34

Menus

Accessory setup menu 72
 Call Diverting menu 48
 Call meters menu 68
 Call related features menu 47
 Extended menu 5
 Messages menu 52
 Network selection menu 64
 Options menu 33
 Personalised menus 5
 Phone Book menu 39
 Phone setup menu 58
 Quick Access menu 73
 Send Messages menu 55
 Short menu 5
 Message editor 55, 74
 Message settings 56

Messages

Call holding/call waiting
 messages 29
 Cell broadcast messages 53
 Creating and editing 53
 Reading SMS messages 53
 Sending SMS messages 55
 Messages menu 52

Mobile Internet

Display features 34
 Editing Text 36
 Ending the session 37
 Internet service alerts 37
 Making and Receiving Calls 36
 Starting the session 36
 Summary of keys 37

My phone number(s) 44
 MyMotorola.com
 Accessing 38

N

Names
 Entering 40
 Network search 65
 Network selection menu 64
Networks
 Automatic search 66
 Change band 65, 75
 Finding new networks 67
 Manual search 66
 New security code 61

O			
One-touch dial setting	46	PIN2 code	61
One-touch dialling	24	Prevent access (to Phone Book)	43
Options menu	33	Q	
Outgoing messages	55, 74	Quick access menu	73
		Customising	76
P		R	
Pauses		Reading SMS messages	53
Inserting into phone numbers	25	Received messages	54
Personal numbers	41	Receiving a phone call	26
Personalised menu	5	Redialling the last number called	24
Phone book		Removing your batteries	18
Call number	42	Require SIM card PIN	60
Deleting/erasing entries	42	Restrict My Number	27
Dialling phone book numbers	25	Restrict my phone number	48, 75
Modify name or number	42	Return call	54
Preventing access to	43	Ring tones	59
Storing numbers - see <i>Add Entry</i>	42	S	
Phone calls		Security code	
Automatic redial	24	Changing	61
Dialling phone book numbers	25	Select Phone Line	59
Emergency calls	25	Sending SMS messages	55
Ending	26	Service centre	56
International	25	Set in-call display	69
Making	24	Set Ringer Tone	59
One-touch dialling	24	Set Ringer Tone 2	59
Receiving	26	Setup fixed dialling	45
Phone setup menu	58	Short menu	5
Phone status	63	Short message service symbol	16
PIN code		Show battery meter	47, 74
Entering	23		
Setting and changing	60	Show call charges	68, 74
		Show call timers	69, 75
		Show Services	43
		Signal strength symbol	16
		SIM card	
		Insertion/removal	21
		PIN code	23, 60
		PIN2 code	61
		SMS messages	52
		Special keys	15
		Split Call	28
		Status indicator	
		Battery saving mode	62
		Status review	63
		Switch Calls	28
		Symbols	16
		T	
		Timers	69
		Tones	
		Setting ringer tones	59
		Transfer Call	31
		Troubleshooting	79
		Turn Mute On or Off	28
		U	
		Unblocking your phone	61
		Unconditional call diversion	75
		Unlock code	
		Setting and changing	59



V

Voicemail
Number 56
Volume
Adjusting the earpiece and
keypad volume 15
Adjusting the ringer volume 59
Buttons 15

W

What to do if... 79

