

Electronic user's guide released subject to "Nokia User's Guides Terms and Conditions, 7th June, 1998"

User's Guide

**NOKIA
5210**



9353875

1. issue

DECLARATION OF CONFORMITY

We, NOKIA CORPORATION declare under our sole responsibility that the product NSM-5 is in conformity with the provision of the following Council Directive: 1999/5/EC. A copy of the Declaration of Conformity can be found from http://www.nokia.com/phones/declaration_of_conformity/

Copyright © Nokia Corporation 2001, 2002. All rights reserved.

Reproduction, transfer, distribution or storage of part or all of the contents in this document in any form without the prior written permission of Nokia is prohibited.

US Patent No 5818437 and other pending patents. T9 text input software Copyright (C) 1997-2001, 2002. Tegic Communications, Inc. All rights reserved.



Includes RSA BSAFE cryptographic or security protocol software from RSA Security.

Nokia and Nokia Connecting People are registered trademarks of Nokia Corporation. Other product and company names mentioned herein may be trademarks or tradenames of their respective owners.

Nokia Xpress-on is a trademark of Nokia Corporation. Nokia tune is a trademark of Nokia Corporation.

Nokia operates a policy of continuous development. Nokia reserves the right to make changes and improvements to any of the products described in this document without prior notice.

Under no circumstances shall Nokia be responsible for any loss of data or income or any special, incidental, consequential or indirect damages howsoever caused.

The contents of this document are provided "as is". Except as required by applicable law, no warranties of any kind, either express or implied, including, but not limited to, the implied warranties of merchantability and fitness for a particular purpose, are made in relation to the accuracy, reliability or contents of this document. Nokia reserves the right to revise this document or withdraw it at any time without prior notice

The availability of particular products may vary by region. Please check with the Nokia dealer nearest to you.

Quick and easy

Thank you for choosing this Nokia phone! These pages give some tips on using your phone. More detailed information is given throughout this user's guide.

■ Before using your phone

1. Insert a SIM card into the phone.
2. Install and charge the battery.
3. Switch on your phone by pressing and holding .

For more information, see Installing the SIM card and the battery and changing the shells on page 23.

■ Call functions

Answering a call

Press .

Making a call

Key in the area code and phone number and press .





Ending/ rejecting a call

Press .

Adjusting earpiece volume

Press the volume keys on the side of the phone.

Last number redial

Press  in the standby mode to view the list of last dialled numbers. Scroll with  or  to the number you want and press .

Calling your voice mailbox



Press and hold . If you are asked for the voice mailbox number, key it in and press **OK**.

■ Phone book functions

Quick save



Key in the phone number and press **Save**. Key in the name and press **OK**.

Quick find

In the standby mode, press , key in the first letter of the name, scroll with  or  to the desired name.

■ Entering menus

Entering / Exiting a menu

Press **Menu**, scroll with  or  to the menu function you want and press **Select**. / Press  to exit a menu function without changing its settings and return to the standby mode.

■ Other essential functions

Locking / Unlocking the keypad

Press **Menu** and then quickly  /

Press **Unlock** and then quickly .

Writing a message

Press **Menu**, ,  and  to start writing a message using either traditional or predictive text input.

Contents

Quick and easy.....	3
FOR YOUR SAFETY.....	13
General information	16
Stickers on the sales package	16
Access codes	16
Ciphering indicator.....	17
Typographics used in the guide.....	18
1. Your phone.....	19
Keys.....	19
Connectors.....	20
Standby mode.....	21
Other essential indicators in the standby mode	21
2. Getting started.....	23
Installing the SIM card and the battery and changing the shells.....	23
Charging the battery	26
Switching the phone on and off	27
Keypad lock (Keyguard).....	28
Putting on the inbox carrying strap	29
3. Call functions.....	30
Making and answering calls.....	30
Making calls.....	30
Making a call using the phone book.....	30
Last number redialling	30

Calling your voice mailbox	30
Speed dialling a phone number	31
Making a conference call.....	31
Answering or rejecting a call	32
Call waiting.....	32
Options during a call	32
4. Phone book (Names)	33
Selecting the phone book settings.....	33
Saving names and phone numbers (Add name).....	34
Searching for names and phone numbers	34
Copying names and phone numbers	34
Erasing names and phone numbers.....	35
Sending and receiving a business card	36
Speed dialling.....	37
Caller groups	37
Service numbers (Service Nos)	38
My numbers.....	38
Voice dialling.....	38
Adding a voice tag	39
Making a call by using a voice tag.....	40
Replaying, changing or erasing voice tags.....	40
5. Using the Menu	41
Accessing a menu function by scrolling.....	41
Accessing a menu function by shortcut	42
List of menu functions.....	43
6. Menu functions	46
Messages (Menu 1).....	46

Writing a message	46
Writing a message with traditional text input.....	47
Writing a message with predictive text input.....	48
Writing compound words.....	50
Reading a text message (Inbox).....	50
Viewing a message you have saved (Outbox).....	51
Erasing messages	51
Chat.....	51
Picture messages.....	52
When you receive a picture message	53
Sending a picture message.....	53
Smileys	53
Templates.....	53
Voice messages.....	54
Info service.....	54
Fax or data call	54
Making a data or fax call	55
Receiving a data or fax call.....	55
Service command editor.....	55
Message settings.....	55
Profile.....	55
Common	56
Call register (Menu 2).....	57
Erase recent call lists	57
Call duration.....	58
Call costs	58
Call cost settings.....	58
Call cost limit.....	58
Show costs in.....	59

Profiles (Menu 3).....	59
Activating and personalising a profile.....	59
Timed profile	60
Profile logo.....	60
Profile name.....	61
Settings (Menu 4)	61
Alarm clock.....	61
Time settings.....	62
Clock	62
Automatic update of date and time	62
Call settings.....	62
Call divert	62
Anykey answer	63
Automatic redial.....	63
Speed dialling.....	63
Call waiting service	64
My number sending.....	64
Line for outgoing calls.....	64
Phone settings	64
Language	64
Cell info display	65
Welcome note.....	65
Network selection.....	65
Confirm SIM service actions	65
Keypad settings.....	66
Locking the keypad automatically	66
Setting the keypad code on	66
Unlocking the keypad with the keypad code.....	67

Tone settings	67
Incoming call alert	67
Ringing tone.....	67
Ringing volume	67
Composer	68
Creating a new ringing tone	68
Vibrating alert.....	69
Rhythmic backlight alert	69
Message alert tone.....	69
Keypad tones.....	69
Warning tones	70
Alert for	70
Accessory settings.....	70
Security settings.....	70
PIN code request.....	71
Call barring service.....	71
Fixed dialling.....	71
Closed user group	71
Security level.....	72
Change of access codes.....	72
Restore factory settings	72
Games (Menu 5).....	73
Starting a game.....	73
Game options	73
Game services and settings.....	74
Calculator (Menu 6).....	74
Using the calculator	75
Making a currency conversion	75
Calendar (Menu 7).....	76

Calendar options.....	76
Making a calendar note.....	77
Infrared (Menu 8).....	78
Sending and receiving data via the IR port	78
Extras (9)	79
Countdown timer.....	79
Setting the normal timer.....	80
Setting the interval timers	80
Stopwatch.....	81
Timing and recording splits.....	82
Lap times	82
Viewing and erasing times	83
Thermometer.....	83
Picture editor	84
Drawing a picture	84
Drawing options	85
WAP services (Menu 10).....	86
Basic steps for accessing and using a WAP service	86
Setting up the phone for a WAP service.....	87
Saving the connection settings received as a text message.....	87
Keying in the connection settings manually.....	87
Making a connection to a WAP service.....	89
Browsing the pages of a WAP service	90
General guidelines for using the keys	90
Ending a WAP connection	91
Adjusting the appearance settings of WAP pages.....	92
Managing bookmarks.....	92
Service inbox.....	93
To set the phone to receive service messages	94

The cache memory.....	94
Authority certificates.....	94
SIM services (Menu 11).....	95
7. Battery information.....	97
Charging and Discharging.....	97
CARE AND MAINTENANCE.....	99
IMPORTANT SAFETY INFORMATION.....	100

FOR YOUR SAFETY

Read these simple guidelines. Breaking the rules may be dangerous or illegal. Further detailed information is given in this manual.



Do not switch on the phone when wireless phone use is prohibited or when it may cause interference or danger.



ROAD SAFETY COMES FIRST

Don't use a hand-held phone while driving.



INTERFERENCE

All wireless phones may get interference, which could affect performance.



SWITCH OFF IN HOSPITALS

Follow any regulations or rules. Switch the phone off near medical equipment.



SWITCH OFF IN AIRCRAFT

Wireless devices can cause interference in aircraft.



SWITCH OFF WHEN REFUELLING

Don't use the phone at a refuelling point. Don't use near fuel or chemicals.



SWITCH OFF NEAR BLASTING

Don't use the phone where blasting is in progress. Observe restrictions, and follow any regulations or rules.

**USE SENSIBLY**

Use only in the normal position. Don't touch the antenna unnecessarily.

**QUALIFIED SERVICE**

Only qualified personnel may install or repair phone equipment.

**ACCESSORIES AND BATTERIES**

Use only approved accessories and batteries. Do not connect incompatible products.

**WATER-RESISTANCE**

Your phone is not water-resistant. Keep it dry.

**BACKUP COPIES**

Remember to make backup copies of all important data.

**CONNECTING TO OTHER DEVICES**

When connecting to any other device, read its user's guide for detailed safety instructions. Do not connect incompatible products.

**CALLING**

Ensure the phone is switched on and in service. Enter the phone number, including the area code, then press . To end a call, press . To answer a call, press .

**EMERGENCY CALLS**

Ensure the phone is switched on and in service. Press as many times as needed (e.g. to exit a call, to exit a menu, etc.) to clear the display. Enter the emergency number, then press . Give your location. Do not end the call until told to do so.

■ Network Services

The wireless phone described in this guide is approved for use on the EGSM 900 and GSM 1800 networks.

Dualband is a network dependant feature. Check with your local service provider if you can subscribe to and use this feature.

A number of features included in this guide are called Network Services. These are special services that you arrange through your wireless service provider. Before you can take advantage of any of these Network Services, you must subscribe to them through your service provider and obtain instructions for their use from your service provider.



Note: Some networks may not support all language-dependent characters and/or services.

Check the model number of any charger before use with this device. This device is intended for use when supplied with power from ACP-7, ACP-8 and LCH-9.



Warning: Use only batteries, chargers and accessories approved by the phone manufacturer for use with this particular phone model. The use of any other types may invalidate any approval or warranty applying to the phone, and may be dangerous.

For availability of approved accessories, please check with your dealer.

When you disconnect the power cord of any accessory, grasp and pull the plug, not the cord.

General information

This chapter gives you some general information on your new Nokia phone and this user's guide.

■ Stickers on the sales package

The stickers contain important information for service and customer support service. Keep these stickers in a safe and secure place.

Attach the **B** sticker to the warranty card of this user's guide.

Attach the **A** sticker to the Club Nokia Invitation Card, if supplied on the sales package.

■ Access codes

The access codes protect against unauthorised use of your phone and SIM card.

- **Security code (five digits)**

The security code, supplied with your phone, protects against unauthorised use of your phone. The preset security code is 12345. Change the security code in the *Settings* menu, see Security settings on page 70. Keep the new code secret and in a safe place separate from your phone.

You can also use security code to protect the keypad lock (keyguard) of your phone, see Setting the keyguard code on on page 66.

- **PIN code (4 to 8 digits)**

The PIN (Personal Identification Number) code protects your SIM card against unauthorised use. The PIN code is usually supplied with the SIM card. Set the phone to request the PIN code each time the phone is switched on, see Security settings on page 70.

- **PIN2 code (4 to 8 digits)**

The PIN2 code, supplied with some SIM cards, is required to access some functions, such as charging unit counters. These functions are only available if supported by your SIM card.

- **PUK and PUK2 codes (8 digits)**

The PUK (Personal Unblocking Key) code is required to change a blocked PIN code. The PUK2 code is required to change a blocked PIN2 code. If the codes are not supplied with the SIM card, contact your local service provider for the codes.

- **Barring password**

The barring password is needed when using the 'Call barring' function. You obtain the password from your service provider.

■ **Ciphering indicator**

Depending on the network, the ciphering indicator  may be displayed during a call to notify that call encryption is off.

For more information, contact your network operator.

■ Typography used in the guide

The display texts that appear on the phone display are indicated in blue colour in this guide, for example *Calling*.

The display texts related to the selection keys  and  are indicated in bold, for example **Menu**. Only the selection key texts without the key symbols are shown in the text.

1. Your phone

■ Keys





1. **Power key.** Pressing and holding the power key on top of your phone switches the phone on or off.

When pressed briefly in the standby mode or during a call, it opens the list of profiles.





When pressed briefly while in the phone book or menu functions it turns the phone's display lights on for approximately 10 seconds.

2. **Volume keys.** The upper key increases and the lower key reduces the phone's earpiece volume.
3. **Selection keys.** Each of these keys performs the function indicated on the display above it.

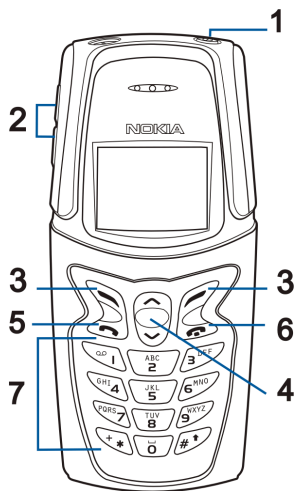
Pressing and holding **Names** activates voice dialling.

4. **Scroll keys.**  and  enable browsing through names, phone numbers, menus or setting options in the phone book and menu functions.
5.  answers a call and dials a phone number.
In the standby mode, it shows the most recently called numbers.
6.  ends or rejects a call and exits from a function.



7.  to  are used to key in numbers and letters.
Pressing and holding  calls your voice mailbox.
 and  are used for various purposes in different functions.

■ Connectors

1. Charger connector
2. Headset connector
3. Infrared (IR) port

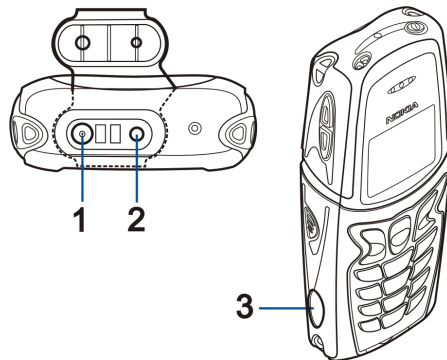

Charger and headset connectors are protected by an integrated flap.

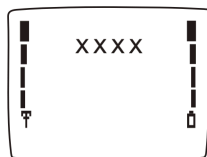

■ Standby mode

When the phone is ready for use, and no characters have been keyed in by the user, the phone is in the standby mode.













-  Shows the signal strength of the cellular network at your current location. The higher the bar, the stronger the signal.
-  Shows the battery charge level. The higher the bar, the more power there is in the battery.

xxxx Indicates the current cellular network in which the phone is being used.

Other essential indicators in the standby mode

In addition to the above three indicators, one or more of the following icons may be shown when the phone is in the standby mode:

-  You have received one or several text or picture messages. See Messages (Menu 1) on page 46.
-  You have received one or several voice messages. See Voice messages on page 54.
-  The phone does not ring or beep when you receive a call since all tones have been set to *Off*. However, your phone will alert, if you have set an alarm. See Tone settings on page 67.
-  The phone's keypad is locked. See Keypad lock (Keyguard) on page 28 and Keyguard settings on page 66.

-  You have set the alarm clock to *On*. See Alarm clock on page 61. Alarm tone will alert even in cases where you have selected a *Silent* profile.
-  You have a timed profile on. See Timed profile on page 60.
-  All your calls are diverted. See Call divert on page 62.
-  Your calls are limited to a closed user group (network service). See Closed user group on page 71.
-  You have connected a headset to your phone. See Accessory settings on page 70.
-  You have set the countdown timer on. See Countdown timer on page 79.
-  You have set the stopwatch on. See Stopwatch on page 81.

2. Getting started

■ Installing the SIM card and the battery and changing the shells

Before changing the cover, always switch off the power and disconnect the phone from the charger or any other device. Always store and use the phone with the covers attached.

Keep all miniature SIM cards out of the reach of small children.

- The SIM card and its contacts can easily be damaged by scratches or bending, so be careful when handling, inserting or removing the card.
- Before installing the SIM card, always make sure that the phone is switched off and then remove the battery.

1. With the back of the phone facing you, take a firm grip of the top and bottom shells. Press both release buttons on the bottom shell inwards and slide the top shell off.

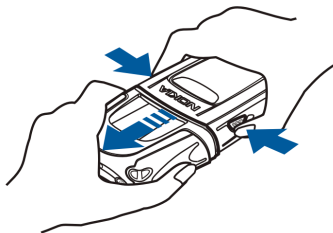

2. Simultaneously press both release springs on the engine part of the phone and slide the bottom shell off.

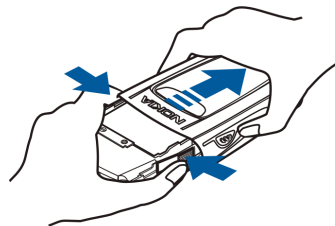

3. Remove the battery by lifting it from the finger grip.

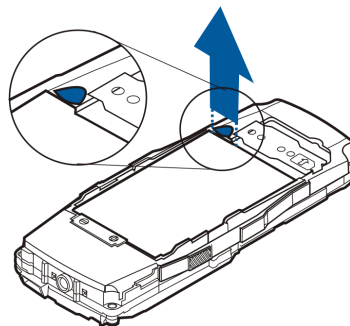

4. Insert your SIM card under the metal plate. Make sure that the golden connectors are facing the connector on the phone, and that the bevelled corner is on the right.

Note that if you need to remove the SIM card, carefully slide it out of the SIM card slot.

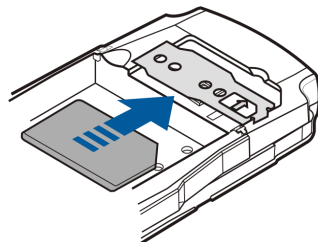

Getting started

5. Replace the battery.

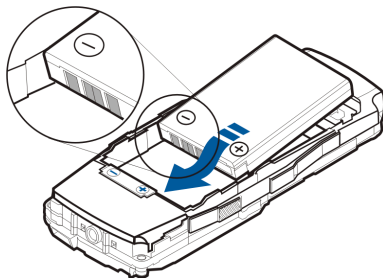

- Slide both shells back together until they lock into place.

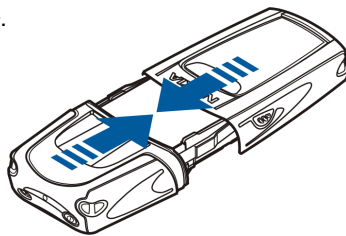

■ Charging the battery

- Lift up the flap protecting the bottom connectors of your phone and carefully connect the lead from the charger to the socket on the bottom of your phone.
- Connect the charger to an AC wall outlet. The battery indicator bar starts to scroll.

The text *Charging* is briefly displayed if the phone is switched on. You can use the phone while charging.

Note that if the battery is totally flat, it may take a few minutes before the charging indication appears on the display or any calls can be made. The charging time depends on the charger and battery used. For example, charging a BLB-2 battery with the ACP-8 charger takes about 2 hours and 10 minutes.

- The battery is fully charged when the battery indicator bar stops scrolling. If the phone is on, the text *Battery full* is also briefly displayed.
- Disconnect the charger from the AC outlet and from the phone.

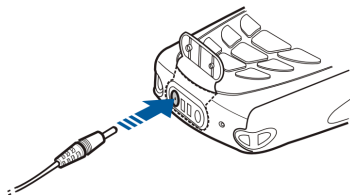

If *Not charging* is displayed, charging has been suspended. Wait for a while, disconnect the charger and plug it in again. If charging still fails, contact your dealer.

For more information, see Battery information on page 97.

■ Switching the phone on and off

Press and hold the power key.

If the phone asks for a PIN code

- Key in the PIN code, which is displayed as asterisks ****, and press **OK**.

See also Access codes on page 16.

If the phone asks for a security code

- Key in the security code, which is displayed as asterisks *****, and press **OK**.

See also Access codes on page 16 and Setting the keyguard code on on page 66.



Warning: Do not switch the phone on when wireless phone use is prohibited or when it may cause interference or danger.



TIPS ON EFFICIENT OPERATION: Your phone has a built-in antenna. As with any other radio transmitting device, do not touch the antenna unnecessarily when the phone is switched on. Contact with the antenna affects call quality and may cause the phone to operate at a higher power level than otherwise needed. Not touching the antenna area during a phone call optimises the antenna performance and the talktime of your phone.



■ Keypad lock (Keyguard)

You can lock the keypad to avoid accidental keypresses, for example, when your phone is in your pocket or purse.

Press **Menu** and then  within 1.5 seconds.

When the keypad is locked,  appears at the top of the display.

Unlocking the keypad

Press **Unlock** and then  within 1.5 seconds.

When the keypad lock is on

- To answer a call press . During a call, the phone can be operated in the normal way. When you end or reject the call, the keypad will be locked automatically.



Note: When Keyguard is on, calls may be possible to the emergency number programmed into your phone (e.g. 112 or other official emergency number). Key in the emergency number and press . The number is displayed only after you have keyed in its last digit.

For automatic keypad lock and keyguard code settings, see Keyguard settings on page 66.

■ Putting on the inbox carrying strap

Thread the carrying strap through any of the four strap holders at each corner of the phone and tighten.

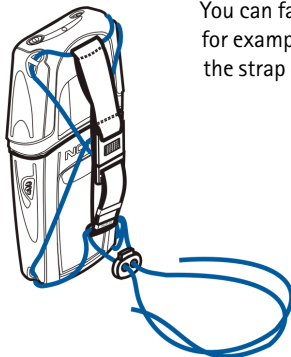
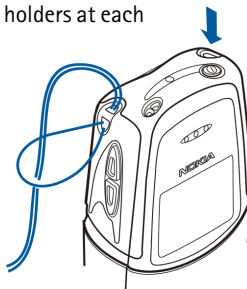





You can fasten the carrying strap in many ways, for example, as shown in the picture. You can tighten or loosen the strap or attach the phone to your bag or rucksack.

3. Call functions

■ Making and answering calls



Making calls

1. Key in the phone number including the area code. To edit a number on the display, press  or  to move the cursor. Press **Clear** to delete the character to the left of the cursor.
For international calls, press * twice for the international prefix (the + character replaces the international access code) and key in the country code, area code and the phone number.
2. Press  to call the number.
3. Press  to end the call or to cancel the call attempt.

Making a call using the phone book

See Searching for names and phone numbers on page 34.



Last number redialling



To redial one of the last 20 phone numbers you called or attempted to call: Press  once in the standby mode and scroll with  or  to the number or name you want.

Calling your voice mailbox

1. Press and hold  in the standby mode.
2. If the phone asks for the voice mailbox number, key it in and press **OK**. See also Voice messages on page 54.

Speed dialling a phone number

If you have assigned a phone number to one of the speed dial keys ( to ), you can call that phone number in either of the following ways:

- Press the speed dial key you want and press .
- If *Speed dialling* is set to on, press and hold the speed dial key ( to ) until the call is started.



See also Speed dialling on page 37.

Making a conference call

Conference call is a network service that allows up to six persons to participate in the same call.

1. While in a call, press **Options**, and select *New Call*.
2. Key in the phone number or search it in the phone book and call the number by pressing **Call**. The first call is put on hold.
3. When the new call has been answered, include the first participant in the conference call by pressing **Options**, and selecting *Conference*
4. To include further participants in the call, repeat steps 1, 2 and 3.
5. To have a private conversation with one of the participants:
Press **Options**, and select *Private*. Select the participant that you want to have a discussion with and press **OK**. Once you have finished the private conversation, return to the conference call, as described in step 3.
6. To end the conference call, press .

Answering or rejecting a call

1. Press  to answer an incoming call.
2. Press  to end the call.



If you do not want to answer the incoming call, you can either ignore or reject it by pressing **Silence** and **Reject**.

Note that if you have activated the call divert, *Divert if busy*, for example, to your voice mailbox, the rejected call will also be diverted. See Call divert on page 62.

Call waiting

With this network service you can answer an incoming call while you have a call in progress if you have activated the Call waiting service on page 64.

While in a call, press  or **Options** and select **Answer**. The first call is put on hold.



- To switch between the two calls, press **Swap** or .
- To reject the waiting call, press **Options** and then **Reject**.
- To end the active call, press .

Options during a call

Your phone provides a number of functions that you can use during a call. Many of the options are network services. By pressing **Options** during a call the following options may be available: **Hold** or **Unhold**, **New call**, **Send DTMF**, **End all calls**, **Phone book**, **Menu**, **Mute** and **Transfer**. **Send DTMF** to send DTMF tone strings, **Swap** to swap between a conference and a private call, **Transfer** to connect an active call and a call on hold, and disconnect yourself from the calls.

4. Phone book (Names)

You can save names and phone numbers in the phone's memory (internal phone book) or in the SIM card's memory (SIM phone book).

- The phone's internal phone book may save up to 250 names and phone numbers. Names and numbers saved in the phone's memory are indicated by the icon .
- The phone supports SIM cards that can save up to 250 names and phone numbers. Names and numbers saved in the SIM card's memory are indicated by the icon .

■ Selecting the phone book settings

1. Press **Names** and select *Settings*.
2. Select *Memory in use*, and scroll to one of the following options:
 - Select *SIM card* to save names and numbers to the SIM card's memory.
 - Select *Phone* to save names and numbers to the phone's memory.
3. Select *Phone book view* and scroll to one of the following options:
 - Name list* to show three names at a time.
 - Name and no.* to show one name and phone number at a time.
 - Large font* to show only a name at a time.
4. Select *Memory status*. Select either *SIM card*: or *Phone*: to check how many names and phone numbers are saved and how many can still be saved in the selected memory.

■ Saving names and phone numbers (Add name)

You can save names and phone numbers in the phone's memory or in the SIM card's memory.

1. Press **Names** and select *Add name*.
2. Key in the name and press **OK**.



For writing instructions, see Writing a message on page 46.

3. Key in the area code and phone number, and press **OK**.





Tip: If you key in the + character for the international prefix (press  twice) in front of the country code, you can use the same phone number when calling from abroad

■ Searching for names and phone numbers

1. Press **Names** and select *Search*.
2. Key in the first letter(s) of the name you are searching for.
3. Press **OK** or scroll with  or  until the name you want appears.



Tip: To quickly find a name and a phone number, press  or  in the standby mode. Key in the first letter of the name and/or scroll to the name you want.

■ Copying names and phone numbers

You can copy names and phone numbers from the phone to the SIM card, or vice versa.

1. Press **Names** and select *Copy*.
2. Select the copying direction, *From phone to SIM card* or vice versa, and press **Select**.

- To copy names and numbers one at a time, select *One by one*. Choose whether to keep or erase the original name and phone number and press **Select**. Scroll to the name and/or phone number you want to copy. Press **Copy** to start copying or **Back** to cancel the operation.
- To copy names and numbers all at once, select *Copy all*. Choose whether to keep or erase the original name and phone number and press **Select**. Press **OK** to start copying or **Back** to cancel the operation.

The name is shortened if it is too long for the target phone book. If the name already exists in the target phone book with a different phone number, an ordinal number is added to the end of the name.

■ Erasing names and phone numbers

You can remove names and phone numbers from the selected phone book one by one or all at once.

Press **Names** and select *Erase*.

- To delete names and numbers one at a time, select *One by one* and scroll to the name (and number) you want to delete. Press **Erase** and confirm with **OK**.
- To delete names and numbers all at once, select *Erase all*. Choose the memory you want to erase, *Phone* or *SIM card* and press **Select**. At the prompt *Are you sure?* press **OK**. Confirm with the security code.

■ Sending and receiving a business card

You can send and receive a person's contact information as a business card via Infrared (IR) or as an Over The Air (OTA) message if supported by the network.

Receiving a business card

1. To make your phone ready to receive data through its IR port, press **Menu** and select *Infrared* (Menu 8).

The user of the other phone can now send the name and phone number through its IR port.

2. Once you have received the name and phone number via IR or as an OTA message, press **Options**, select *Show*, *Save* or *Discard*, and press **OK**.

Sending a business card

Using your phone's IR port you can send a person's contact information as a business card from your phone to another compatible phone or PC running an appropriate application.

1. Search for the name and phone number you want to send from the phone book and press **(Details)** and **Options**.
2. To send the business card via IR, make sure that the other phone or the PC is set up to receive data via its IR port and select *Send via IR*. To send the business card as an OTA message, select *Send*.

■ Speed dialling

To assign a number to a speed dial key, take the following steps:

1. Press **Names** and select *Speed Dials*. If no phone number is assigned to a key, press **Assign**.

Assign is also shown when the phone suggests allocating a phone number from the phone book to a speed dial key.

If a phone number is already assigned to a key, you can view the number, change it or erase it by first pressing **Options**.

2. Search for the name and/or phone number you want to find from the phone book, and press **OK**.

Making a call by using the speed dial keys, see Speed dialling a phone number on page 31.

■ Caller groups

You can arrange the names and phone numbers saved in the phone book into caller groups. For each caller group, you can set the phone to sound a specific ringing tone and show a selected graphic on the display when you receive a call from a phone number in the group.

You can also set the phone to ring only when you receive calls from phone numbers that belong to a specific caller group. See also Alert for on page 70.

Press **Names**, select *Caller groups* and scroll to the caller group you want, for example *Business*. Select

- *Rename group* to edit the caller group name.
- *Group ringing tone* to set the ringing tone for the caller group. Scroll to the caller group you want and press **OK**. *Default* is the ringing tone selected for the active profile.
- *Group logo* to set a graphic for the caller group. The options are *On*, *Off*, *View logo*, *Send via IR*, *Send logo* (send via SMS).

If you selected *Send logo* (network service), key in the recipient's phone number or search for it from the phone book and press **OK**.

■ Service numbers (Service Nos)

You can call the service numbers of your service provider if the numbers are included on your SIM card. *Service nos.* is shown only if supported by your SIM card.

- Press **Names**, select *Service nos.* and find the service number you want and press .

■ My numbers

This function is a memory aid, which you can use to check your own phone numbers if you need to do so.

Within this menu you can save, erase, edit and send phone numbers, if this is allowed by the SIM card. The edits that you make here do not affect in any way the actual subscriber number(s) of your SIM card.

■ Voice dialling

You can make a phone call by saying a voice tag that has been added to a desired name and phone number. Any spoken word(s), such as a person's name, can be a voice tag.

Before using voice dialling, note that:

- Voice tags are not language dependent. They are dependent on the speaker's voice.
- Voice tags are sensitive to background noise. Record them and make calls in a quiet environment.
- When recording a voice tag or making a call by saying a voice tag, hold the phone in the normal position near to your ear.

- Very short names are not accepted. Use long names and avoid similar names for different numbers.



Note: You must say the name exactly as you said it when you recorded it. This may be difficult in, for example, a noisy environment or during an emergency, so you should not rely solely upon voice dialling in all circumstances.

Adding a voice tag

You can add up to ten voice tags to phone numbers. Save or copy the names and phone numbers to which you want to add a voice tag in your phone's memory.

Voice tags can also be added to names and phones numbers on your SIM card, but the voice tags may be erased if you move your SIM card to another phone or use another SIM card in your phone.

1. Press **Names** and select **Search**.
2. Scroll to the name and number to which you want to add a voice tag and press (**Details**) and **Options**.
3. Select **Add voice tag**.
4. Press **Start** and hold the phone in the normal position near to your ear and say clearly the word(s) you want to record as a voice tag.
5. The phone plays the recorded tag. If you do not want to save the recording, press **Quit**.
6. When the voice tag has been successfully saved, **Voice tag saved** is displayed.

Making a call by using a voice tag

1. Press and hold **Names** in the standby mode to activate voice dialling. Say the voice tag clearly while holding the phone in the normal position near to your ear.
2. If no match for the voice tag is found or recognised, the phone may ask you to try again. Press **Yes** to activate voice dialling again, or **Exit** to return to standby mode.
3. The phone automatically dials the number of the recognised voice tag and **Searching** is displayed. If you are using the HDC-5 headset, press and hold the headset button to start voice dialling.

Replaying, changing or erasing voice tags







1. Press **Names** and select **Voice tags**.
2. Scroll to the name (or phone number) with a voice tag you want to change, and press **Options**.
 - To replay the voice tag, select **Playback** and press **OK**.
 - To change the voice tag, select **Change** and press **OK**. Press **Start** to record a new voice tag. See Adding a voice tag on page 39 for details.
 - To erase the voice tag, select **Erase** and press **OK**. When **Erase voice tag?** is displayed, press **OK**.



5. Using the Menu

The phone offers you an extensive range of functions that allow you to tailor the phone to your needs. These functions are arranged in menus and submenus.

Most of the menu functions are provided with a brief help text. To view the help text, scroll to the menu function you want and wait for 15 seconds.

■ Accessing a menu function by scrolling

1. To enter the main menu, for example *Settings*, press **Menu**, scroll with  or  to *Settings* and press **Select**.
2. If the menu contains any submenus, for example *Call settings*, scroll with  or  to the one you want and press **Select**.
If the menu you have selected contains submenus, repeat this step.
3. Scroll with  or  to the setting you want and press **OK**. To return to previous menu level, press **Back**.

 **Tip:** You can exit the menu without changing the menu settings by pressing  or by pressing and holding **Back**.

■ Accessing a menu function by shortcut

The menus, submenus and setting options are numbered and can be accessed quickly by using their shortcut numbers. The shortcut number is shown in the top right corner of the display. For menu shortcuts, see the list of menu functions.

1. Press **Menu** in the standby mode.
2. Within three seconds, key in the first digit of the shortcut number. Repeat this for each digit of the shortcut number.

List of menu functions

1. Messages

1. Write messages
2. Inbox
3. Chat
4. Outbox
5. Picture messages
6. Templates
7. Smileys
8. Erase messages
9. Voice messages
10. Info service
11. Fax or data call
12. Service command editor
13. Message settings
 1. Profile¹
 1. Message centre number
 2. Messages sent as
 3. Message validity
 4. Rename sending profile
 2. Common
 1. Delivery reports



2. Reply via same centre
3. Character support

2. Call register

1. Missed calls
2. Received calls
3. Dialed numbers
4. Erase recent call lists
5. Call duration
 1. Last call duration
 2. All calls' duration
 3. Received calls' duration
 4. Dialed calls' duration
 5. Clear timers
6. Call costs
 1. Last call cost
 2. All calls' cost
 3. Call cost settings



3. Profiles

1. General
 1. Activate



1. The number of profiles depends on how many profiles your SIM card offers. Each profile appears in its own submenu and may have any name.

- 2. Personalise
 - 3. Timed
 - 2. Silent
 - 3. Meeting
 - 4. Outdoor
 - 5. (empty)
 - 6. (empty)
 - 4. Settings
 - 1. Alarm clock
 - 2. Time settings
 - 1. Clock
 - 2. Auto update of date and time
 - 3. Call settings
 - 1. Call divert
 - 2. Anykey answer
 - 3. Automatic redial
 - 4. Speed dialling
 - 5. Call waiting service
 - 6. My number sending
 - 7. Line for outgoing calls
 - 4. Phone settings
 - 1. Language
 - 2. Cell info display
- 
- 3. Welcome note
 - 4. Network selection
 - 5. Confirm SIM service actions
 - 5. Keyguard settings
 - 1. Automatic keyguard
 - 2. Keyguard code
 - 6. Tone settings
 - 1. Incoming call alert
 - 2. Ringing tone
 - 3. Ringing volume
 - 4. Composer
 - 5. Vibrating alert
 - 6. Rhythmic backlight alert
 - 7. Message alert tone
 - 8. Keypad tones
 - 9. Warning tones
 - 10.Alert for
 - 7. Accessory settings¹
 - 1. Headset
 - 2. Handsfree
 - 8. Security settings
 - 1. PIN code request
 - 2. Call barring service
 - 3. Fixed dialling
 - 4. Closed user group

1. The accessory settings are shown only if the phone is or has been connected to a compatible accessory.

- 5. Security level
- 6. Change of access codes
- 9. Restore factory settings

8. Infrared



9. Extras

- 1. Countdown timer
- 2. Stopwatch
- 3. Thermometer
- 4. Picture editor



5. Games

- 1. Select game
- 2. Game services
- 3. Settings



6. Calculator



10. Services



7. Calendar



11. SIM services¹



1. The SIM services are available only if your SIM card supports them.

6. Menu functions

■ Messages (Menu 1)



With the Short Message Service (SMS) network service you can send short text messages to phones which have SMS capability.

Before you can send any text or picture messages, you need to save your message centre number in the phone, see Message settings on page 55. You will receive the number from your service provider when you subscribe to the Short Message Service.



Note: When sending messages via the SMS network service, your phone may display the words *Message sent*. This is an indication that the message has been sent by your phone to the message centre number programmed into your phone. This is not an indication that the message has been received at the intended destination. For more details about SMS services, check with your service provider.

Writing a message

You can write multi-part text messages of almost up to three ordinary text messages in length (network service). Note, however, that invoicing is based on how many ordinary messages are needed for any multi-part message.

1. Press **Menu**, select *Messages*, and then *Write messages*.
2. Key in a message. See Writing a message with traditional text input on page 47 or Writing a message with predictive text input on 48.
3. To send the message, press **Options** and select *Send*.
4. Enter the recipient's phone number and press **OK** or



search for the phone number from the phone book and select *Search*. Press **OK** to send the message.







By pressing **Options** you can also find the following:

- *Send to many* to send the message to several persons.
- *Use template* to insert or use parts of preset text messages saved in your phone. See also Templates on page 53.
- *Insert smiley* to add smiley characters, such as :-).
- *Insert word* to add a word in traditional text input, *Insert number* to add a number and *Insert symbol* to add a special character. These options are shown, if you have set *Dictionary* on, see Writing a message with predictive text input on page 48.
- *Dictionary* to set the predictive text input on and select the language.
- *Sending profile* to send the message to a pre-selected set. See Message settings on page 55.
- *Save* to save the message in the *Outbox* for use at a later time.
- *Clear text* to remove all the characters that you have keyed in from the display.

Writing a message with traditional text input

The traditional text input is indicated by  at the top of the display.

- When writing text, press a number key ( to ) repeatedly until the character you want appears.
- To switch between upper and lower character case, press . The symbol **ABC** or **abc** at the top of the display indicates the selected case. After a full stop the first letter is automatically a capital one.
- To insert a number, press and hold the number key you want.

- To switch between letters and numbers, press and hold . Numbers are indicated by 123 at the top of the display.
- To add a space, press .
- To add a punctuation mark or special character, press . Move through the list to the character you want with  or  and press **Use**.
- If you make a mistake, press **Clear** to remove a character to the left of the cursor as many times as necessary. Pressing and holding **Clear** clears the screen.
- To move the cursor left and right, respectively, press  or .

Writing a message with predictive text input

With predictive text input you can key in any characters by single keypresses. The predictive text input is based on a built-in dictionary to which you can add new words. When the dictionary becomes full, the new word replaces the oldest added one. The predictive text input is indicated by  at the top of the display.

Setting the predictive text input on or off

1. Press **Menu** and select **Messages**.
2. Select **Write messages**, press **Options** and select **Dictionary**.

To set the predictive text input on:

- Select the language you want from the options list, **T9 dictionary on** is displayed.

To set the predictive text input off:

You can change from the predictive text input to the traditional text input by selecting **Dictionary off**. The phone displays **T9 dictionary off**.



Tip: To quickly set the predictive text input off, press **#*** twice when writing text.



Writing words with predictive text input

1. Start writing a word by using the keys **ABC 2** to **9 WXYZ**. Press each key only once for each letter. Do not pay attention to the word on the display until you have completed writing it.



For example, to write 'Nokia' when the English dictionary is selected, press **6^HNO** (for N), **6^HNO** (for o), **JKL 5** (for k), **GH 4** (for i), and **ABC 2** (for a).



- To delete a character, press **Clear**. To clear the screen, press and hold **Clear**.
- To change the character case, press **#***. To change between the letter and number mode, press and hold **#***.
- To insert a symbol, press and hold **+***, or press **Options** and select **Insert symbol**. Then, scroll to the symbol you want and press **Use**.
- To insert a word, press **Options** and select **Insert word**. Write the word using traditional text input and press **OK**.
- To insert a smiley, press **Options** and select **Insert smiley**. Scroll to the smiley you want and press **Select**.

- To insert a number in character mode, press and hold the respective number key, or press **Options** and select *Insert number*. Key in the number(s) and press **OK**.
2. When you have finished writing the word and it is correct, confirm it by pressing  or by adding space with .
 3. If the word is not correct, you have the following options:
 - Press  repeatedly until the word you want appears and confirm it.
 - Press **Options**, scroll to *Matches* and press **OK**. Scroll through the words and select the correct one by pressing **Use**.

Writing compound words

When writing a compound word, write the first part of the word and press . Continue writing the last part of the word and press  or .

Reading a text message (Inbox)

When you receive a text message, you hear a message alert tone,  and the number of new messages is shown.

When  flashes your phone has no more space for new messages. Before you can receive or send new messages, erase some of the existing messages.

1. Press **Read** to view the message, or **Exit** to view it later
To view the messages later, press **Menu**, select *Messages*, and then *Inbox*.
2. While reading the message, press **Options** to display one of the following options: *Erase*, *Reply*, *Chat*, *Edit*, *Use number*, *Forward*, *Details*.

With *Chat* you can exchange text messages with another person. For more information, see *Chat* on page 51.

Viewing a message you have saved (Outbox)

You can save your own messages in *Outbox*.

1. Press **Menu**, select *Messages*, and then *Outbox*.
2. Scroll to the desired message and press **Read** to view it.
3. Pressing **Options** while you are reading a message allows you to access the same functions as *Inbox*, except for *Reply* and *Details*.

Erasing messages

You can erase read messages folder by folder.

1. Press **Menu**, select *Messages*, and then *Erase messages*.
2. Scroll to the desired folder and press **OK**. When *Erase all read messages from folder?* is displayed, press **OK**.

Chat

You can converse with another person by exchanging text messages.

1. Press **Menu**, select *Messages*, and select *Chat*. Or:
While reading a received text message, press **Options** and select *Chat*.
2. Key in the other person's phone number or search for it from the phone book (see *Making a call using the phone book* on page 30), and press **OK**.

3. Key in a nickname you want to use in the chat and press **OK**. See Writing a message on page 46.
If you have previously had a chat with the same person, the last 600 characters of this chat are shown.
4. Write your chat message as you would a normal text message, press **Options** and select **Send**.
5. The reply message from the other person is shown above the message you sent. To reply to the message, press **OK**, write your reply and send it by pressing **Options** and selecting **Send**.
By pressing **Options** you can access the same functions as when writing a text message, see Writing a message on page 46.
Chat history shows up to 600 characters sent (indicated by "<" and your nickname) and received (indicated by ">" and the sender's nickname) during the current chat and *Chat name* allows you to edit your nickname.

Picture messages

You can send and receive messages containing pictures. You can also edit pictures or clip-art either in the *Picture messages* or in the *Picture editor* menu. See also Picture editor on page 84.



Note: This function can be used only if it is supported by your network operator or service provider. Only phones that offer picture message features can receive and display picture messages.

Each picture message is made up of several text messages. Therefore, sending one picture message may cost more than sending one text message.

Since picture messages are saved in the phone, you cannot view them if you use the SIM card with another phone.

When you receive a picture message

- To view the message immediately, press **View**. You can save the message by pressing **Save**.
- To view the message later in this menu, press **Exit** and then **OK** to save the message.

Received picture messages are saved in a separate folder for picture messages. If there is no space for a new message, you need to select one of the old messages first and replace it with the new one.

Sending a picture message

1. In the *Picture messages* menu, select one of the preset pictures and press **View**.
2. Press **Options** and select *Edit text*. Write the message.
3. To view the whole message before sending it, press **Options**, scroll to *Preview* and press **OK**.
4. To send the message, press **Options** and select *Send*.

Smileys

With this function you can edit smiley characters such as ":-)" that you can use when writing or replying to a message. Press **Menu**, select *Messages*, and select *Smileys*. To edit a smiley, press **Options** and select *Edit*.

Templates

Your phone offers some preset text messages, *Templates*, which you can use in writing or replying to messages.

You can view, edit and erase the message templates to your liking, but the original templates will be restored when you select *Restore factory settings*.

Voice messages

Voice mailbox is a network service and you may need to subscribe to it before you can use it. For more information, contact your service provider.

Press **Menu**, select *Messages*, and *Voice messages*.

- Select *Listen to voice messages* to call your voice mailbox. Each phone line may have its own voice mailbox number, see Line for outgoing calls on page 64.



Tip: Alternatively, press and hold  in the standby mode.

- Select *Voice mailbox number* to save the phone number of your voice mailbox. You obtain the number from your service provider. Key in the number and press **OK**.

Info service

With this network service you can receive messages on various topics, such as weather or traffic conditions, from your service provider. For available topics and relevant topic numbers, contact your service provider.

Fax or data call

Before using this function you need to activate the IR port of your phone and ensure that your phone is connected to a compatible device, see Infrared (Menu 8) on page 78.

Making a data or fax call

1. Press **Menu**, select *Messages*, and then *Fax or data call*.
2. Scroll to *Fax and data* or *Also voice* and press **OK**. *Also voice* allows you to switch from voice mode to data (or fax) mode during a call.
3. Key in or search for the desired phone number and press **OK**.
4. If you selected *Also voice* in step 2, press **Options** to switch between voice and data/fax mode during a call, select *Voice Mode* or *Data Mode* (or Fax Mode) and press **OK**.
5. After the transmission, end the call by pressing .

Receiving a data or fax call

You can answer a data or fax call in the normal way, even if the phone keypad is locked.

Service command editor

You can send service requests to your service provider, such as the activation commands of network services.

Message settings

The message settings affect the sending of text messages. Press **Menu**, select *Messages* and *Message settings*.

Profile

The profile is a collection of the settings required for sending text messages. If more than one profile set is supported by your SIM card, select the set you want to change.

You can, for example, send a text message as a fax (provided that this function is supported by your service provider) by simply selecting the profile in which you have defined the proper settings for fax transmissions.

Each profile has its own submenu:

- *Message centre number* to save the phone number of the message centre needed for sending text messages.

Key in or edit the phone number and confirm with **OK**.

- *Messages sent as* to request the network to convert your *Text* messages into alternative formats *Fax*, *Paging* or *E-mail* (network service).

In order to receive a converted message, the recipient must have the appropriate equipment, for example a fax machine.

- *Message validity* to set the length of time that your text messages are saved at the message centre while attempts are made to deliver them (network service).
- *Rename sending profile* to edit or change the profile name.

Common

- *Delivery reports* to request the network to send delivery reports on your messages (network service).
- *Reply via same centre* to request the network to route the reply message via your own message centre (network service).
- *Character support* you can select the *Unicode* option of *Character support* to send messages using special characters, such as ñ, in Romance and Slavic languages or Russian characters to a compatible phone, if supported by your network.



■ Call register (Menu 2)



Your phone registers the phone numbers of missed, dialled and received calls and the approximate length and cost of your calls.

The phone registers missed and received calls only if the network supports these functions, the phone is switched on and it is within the network's service area.

When you press **Options** in the *Missed calls*, *Received calls* or *Dialled numbers* menu, you can view the date and time of the call, erase the phone number from the list or view, edit and save the number in the phone book.

Press **Menu** and select *Call register*. Select

- *Missed calls* to view the last 10 phone numbers from which somebody has tried to call you with no success (network service).

 **Tip:** When a note about missed calls is being displayed, press **List** to see the list of phone numbers. Scroll to the number you want to call back and press .

- *Received calls* to view the last 10 phone numbers from which you have most recently accepted calls (network service).
- *Dialled numbers* to view the last 20 phone numbers that you have called or tried to call.

Erase recent call lists

You can erase all recent call lists of missed, received and dialled numbers. The phone numbers are also erased if you

- switch on the phone with a SIM card inserted which is not one of the five SIM cards most recently used with the phone.

- change the *Security level* settings, see Security level on page 72.

Call duration

You can view the approximate duration of your incoming and outgoing calls. You can clear the call timers by using *Clear timers*. For that you need the security code. See Access codes on page 16.



Note: The actual time invoiced for calls by your service provider may vary, depending upon network features, rounding-off for billing, and so forth.

Call costs

With this network service you can check the approximate costs of your last call, all calls and clear the counters. To clear the counters you may need to have the PIN2 code. See Access codes on page 16.

The costs are shown in terms of units set within *Show costs in* for each SIM card.



Note: The actual invoice for calls and services from your service provider may vary, depending upon network features, rounding-off for billing, taxes and so forth.

Call cost settings

Call cost limit

With this network service you can limit the costs of your calls to a selected number of charging units or units of currency.

If you have selected *On*, the number of remaining units is shown in the standby mode.

You can make and receive charged calls as long as the specified cost limit is not exceeded.

Depending on the SIM card, you may need the PIN2 code to set a call cost limit. See Access codes on page 16.

Show costs in

The phone can show the call cost limits in terms of charging units or the desired currency. Contact your service provider for charging unit prices.

To select the currency or unit in this menu, you may need the PIN2 code. See Access codes on page 16.

■ Profiles (Menu 3)

Your phone has a set of profiles that offer you a convenient way of personalising the tones of your phone to suit a variety of events and environments. You can also set on a profile for a certain time period.



You can replace *(empty)* with a profile you have received, for example, from your service provider. For availability and other information, contact your service provider or other profile provider.

Activating and personalising a profile

Press **Menu**, select *Profiles*, and then one of the following profiles: *General*, *Silent*, *Meeting*, *Outdoor* or one of the *(empty)* profiles.

- Select *Activate* to change or activate a new profile.

 **Tip:** You can also change the profile by quickly pressing the power key in the standby mode, scrolling to the profile you want to activate and then pressing **OK**.

- Select *Personalise* to set the profile settings to your liking. Select the option you want to change, change the setting and press **OK**.

You can also change the tone settings of the profile in use in *Tone settings*, see Tone settings on page 67.



Tip: If you want to activate the *Silent* profile quickly, press the power key and . To change to the *General* profile, press the power key and .

Timed profile

You can activate a profile for a certain time up to 24 hours. When the time set for the profile expires, your phone returns to the profile that was active before the timed profile.

1. Press **Menu**, select *Profiles*, and select the profile you want to activate.
2. Scroll to *Timed* and press **OK**.
3. Key in the time in hours and minutes after *Profile expires:*

Note that you must set the clock before you can time a profile. See Clock on page 62.

4. Press **OK** to confirm the time you have set.

Timed profile is displayed with a clock indicator in the standby mode.

Profile logo

Sets the picture that is displayed in standby mode after a selected period of time (called 'timeout'). You can set the phone's own still and animated pictures as a profile logo.

- Select *Off* to set the profile logo off, *On* to activate the timeout and profile logo selected previously, *Timeout* to set a time when the profile logo activates.
- *Profile logo* displays the currently active profile logo. To change it, scroll to the profile logo you want and press **Use**.

Note that you must set the clock before you can select it as a profile logo. See Clock on page 62.

Profile name

Edits the name of the selected profile. Only the *General* profile cannot be renamed.

■ Settings (Menu 4)



Alarm clock

The alarm clock uses the 12-hour or 24-hour time format set for the clock. The alarm clock will alert even if the phone is switched off.

1. Press **Menu** and select *Settings*.
2. Key in the alarm time and press **OK**.

If the alarm time is set, select *On* to change the time or *Off* to turn the alarm clock off.

When the alarm time expires

The phone sounds an alert tone, *Alarm!* is displayed and the phone's lights flash. Press **Stop** to stop the alarm. If you let the phone alarm for a full minute or press **Snooze** or any other key, the alarm stops for a few minutes and then resumes.

If the alarm time is reached while the phone is switched off, the phone switches itself on and starts sounding the alarm tone. If you press **Stop**, the phone asks whether you want to activate the phone for calls. Press **No** to switch off the phone or **Yes** to make and receive calls.



Note: Do not press Yes when wireless phone use is prohibited or when it may cause interference or danger.

Time settings

Clock

You can show or hide the clock on the display, set the time and select between the 12-hour or 24-hour time formats. You can also set the clock as a full-screen profile logo. See also Profile logo on page 60.

If the battery is removed from the phone for a long time, you may need to set the time again.

You also need clock settings in the following functions *Alarm clock*, timed *Profiles*, clock as a *Profile logo* and *Calendar*.

Automatic update of date and time

This network service updates the clock in your phone according to the current time zone. The following options are available:

- *On* updates the time and date automatically.
- *Confirm first* requires confirmation for the update.
- *Off* no updates are done.

Call settings

Call divert

You can use this network service to forward incoming calls to your voicemailbox (only voice calls) or to another number. Divert options not supported by your network operator may not be shown.

1. Press *Menu*, select *Settings*, and then *Call divert*.

2. Select one or several call divert options:

Divert all voice calls, *Divert if busy* and *Divert if not answered* for voice calls only.
Divert if out of reach, *Divert all fax calls*, *Divert all data calls* and *Cancel all diverts*.

3. For a mode, you may select *Activate*, *Cancel*, *Check status* or *Set delay*.

To check whether the divert option is activated or not, select *Check status*. To change the timeout when the call is diverted, if available for the divert option, select *Set delay*, then *Activate* to set the call divert on.

When all calls are diverted,  is shown on the standby mode.

Each phone line may have its own divert settings.

 **Tip:** If *Divert if busy* is activated, rejecting an incoming call will also divert a call.



Anykey answer

With anykey answer activated, you can answer an incoming call by pressing any key briefly, except the power key,  or *Silence* followed by *Reject*.

Automatic redial

When this function is set on, your phone will make up to ten attempts to connect the call after an unsuccessful call attempt.

Speed dialling

When speed dialling is activated, you can dial the names and phone numbers assigned to the speed dial keys, from  to , by pressing and holding the corresponding number key. Pressing and holding  dials your voice mailbox number.

Call waiting service

When this network service is activated, the network will notify you of a new incoming call while you have a call in progress. The phone sounds a soft alert tone.

My number sending

With this network service you can set whether your phone number is shown or hidden from the person you are calling. *Set by network* resets the phone to the default setting, *On* or *Off*, that you have agreed upon with your service provider.

Line for outgoing calls

With this network service you can select the phone line (that is, subscriber number) 1 or 2 for making calls. You can also prevent line selection. For more information on availability, contact your network operator or service provider.

If you select line 2 and have not subscribed to this network service, you cannot make calls. However, calls on both lines can be answered regardless of the selected line.

When you have prevented the line selection within 'Phone line change', you cannot use this function.



Tip: In the standby mode you can switch from one line to the other by pressing and holding



Phone settings

Language

Within this menu you can select the language in which the display texts will be shown. If the setting *Automatic* is selected, the language used is chosen based on the current SIM card. English will be used if the language on the SIM card is not found in the phone.

Cell info display

With this network service, you can set the phone to indicate when it is used in a cellular network based on Micro Cellular Network (MCN) technology (network service).

Welcome note

You can set the message (up to 36 characters in length) which is shown briefly when the phone is switched on.

Network selection

The cellular network to which your phone is connected can be selected either automatically or manually.

In *Automatic* mode, the phone automatically selects one of the cellular networks available in your area.

In *Manual* mode, the phone shows a list of the available networks and you can select the network you wish to use if this network has a roaming agreement with your home network operator. If no such agreement is in force, the text *No Access* will be displayed and you must select another network. The phone stays in manual mode until the automatic mode is selected or another SIM card is inserted into the phone.

Confirm SIM service actions

You can set the phone to display the confirmation message when you are using SIM card services. See SIM services (Menu 11) on page 95.

Keypad settings

When the keypad is locked,  appears at the top of the display.



Note: When Keypad Lock is on, calls may be possible to the emergency number programmed into your phone (e.g. 112 or other official emergency number). Key in the emergency number and press . The number is displayed only after you have keyed in its last digit.

Locking the keypad automatically

You can set the keypad of your phone to lock automatically after a preset time delay. You can set the delay time from 10 seconds up to 59 minutes 59 seconds and when the time is up, the keypad locks automatically preventing accidental keypresses.

1. Press **Menu**, select *Settings*, and then *Keypad settings*.
2. Select *Automatic keypad*.
3. When you select *On*, the phone displays *Set delay*: Key in the time.

Note that the keypad locks automatically if your phone is in the standby mode and the preset time delay expires.

Setting the keypad code on

You can also protect the keypad with the keypad code. The keypad code is the same as your five-digit security code.

Before setting the keypad code to *On* make sure that the PIN code request is also set on.

1. Press **Menu**, select *Settings*, and *Keypad settings*.
2. Select *Keypad code* and press **OK**.
3. At *Security code*: key in your security code and press **OK**. See also Change of access codes on page 72.

4. Select *On* and the *Keypguard code activated* is displayed.

Unlocking the keypad with the keyguard code

1. In the standby mode, press **Unlock**.
2. At *Security code*: key in your security code and press **OK**.

Note that despite the keyguard code, you can answer a call. The keypad lock is reactivated once the call is finished.

Tone settings

In the *Tone settings* menu you will find the same tone settings as in the *Profiles* menu, see also Profiles (Menu 3) on page 59.

Incoming call alert

You can define how the phone notifies you of an incoming voice call. The options are: *Ringling*, *Ascending*, *Ring once*, *Beep Once*, and *Off*.

Ringling tone

Sets the ringling tone for voice calls.

You can receive ringling tones as an Over the Air (OTA) message. To play, save, or erase the tone, press **Options**, scroll to the tone you want, and press **OK**.

Ringling volume

Sets the volume level for the ringling and message alert tones.

Composer

You can compose a ringing tone of your own. The composed tones are shown last in the ringing tone list.



Note: Your phone must be switched on to use this function. Do not switch the phone on when wireless phone use is prohibited or when it may cause interference or danger.

Creating a new ringing tone



1. Scroll to the tone you want to edit and press **Select**.
2. Enter the desired notes. For example, press for note f (shown as *f*). The phone plays each note after it is entered (unless the phone tones are off).
3. To adjust the characteristics of the note:

- **Note duration:** shortens (-) and lengthens (+) the duration of the note or rest. The default duration is 1/4. The duration is shown in front of the note, for example *1/16d* denotes a note d with duration 1/16.

Pressing and holding a note key lengthens the note by half, indicated by a dot after the duration, e.g. *8.a*.

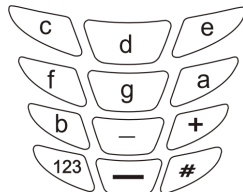
- **Rest:** inserts a rest (that is, a pause) of the same duration as the previous note. The default duration of a rest is one quarter note (1/4). The rest is indicated by the - character.
- **Octave:** sets the octave for new notes. The octave is shown as a number after the note (e.g. *e1*).
- **Pitch:** makes the note sharp (indicated by # in front of the note), e.g. *#f*. The pitch selection is not available for notes e and b.



- To edit the notes:
 -  and  move the cursor right or left, respectively.
 - Clear** deletes a note or a rest to the left.
- After you have completed the tone, press **Options**, select one of the following options, and press **OK**: *Play*, *Clear screen*, *Exit*,
Select *Save* to name the tone and add it to the ringing tone list, *Tempo* to set a tempo for the tone (in beats per minute) or *Send* to send the composed tone as a text message to a compatible phone.

Vibrating alert

Sets the phone to vibrate during an incoming call, message alert and silent alert. You can select *On*, *Off*, *Rhythm* or *Vibra then ring* for vibrating alert. The vibrator does not operate when the phone is connected to a charger or a deskstand.

Rhythmic backlight alert

Sets the backlights of the phone to flash rhythmically during an incoming call, message alert and silent alert.

Message alert tone

Sets the ringing tone for text messages. You can also select the message alert tone from a ringing tone list or it can be a composed tone.

Keypad tones

Sets the volume level for keypad tones.

Warning tones

Sets the phone to sound a warning tone, for example when the battery is running out of power or when you play one of the games offered by your phone. This setting has no effect on network service related tones.

Alert for

Sets the phone to ring only upon calls from phone numbers that belong to a selected caller group. See also Caller groups on page 37.

Accessory settings

This submenu appears only after the phone is or has been connected to one of the accessories: headsets HDC-5, HDE-2, mobile inductive loopset LPS-3 or HDR-1 music player.

1. Press **Menu**, select *Settings* and then *Accessory settings*.
2. Select either *Headset* or *Handsfree*. Some of the settings below are available for the accessory:
 - *Default profile*
 - *Automatic answer*
 - *Lights*

Security settings

Your phone is equipped with a versatile security system to prevent unauthorised use of the phone or the SIM card. See also Access codes on page 16.



Note: When security features, that restrict calls, are in use (call barring, closed user group and fixed dialling), calls may be possible to certain emergency numbers in some networks (e.g. 112 or other official emergency numbers).

PIN code request

You can set the phone to ask for the PIN code of your SIM card every time the phone is switched on. You need the PIN code to turn this request function on. Some SM cards do not allow the PIN code request to be turned off.

Call barring service

With this network service, you can restrict the making and receiving of calls with your phone. For this function you need the barring password.

When you make a call while the call barring is set on, the phone may display a note reminding you of this.

Fixed dialling

This service restricts your outgoing calls to selected phone numbers, if this function is supported by your SIM card. To set this function on or off, or to save, edit or erase the numbers on the list, you need to have the PIN2 code.

Closed user group

This network service specifies the group of people to whom you can make a call and who can call you. *Default* resets the phone to use a user group that the SIM card owner has agreed upon with the service provider.

Security level

You can set the phone security level on to avoid unauthorised use of the phone. You need the security code to set the security level. The available options are:

- *None* no security code is needed.
- *Memory* security code is required when the phone book memory is selected.
- *Phone* security code required when a new SIM card is inserted.

Note that when you change the security level, all the recent calls lists are cleared.

Change of access codes

You can change the following access codes: security code, PIN code, PIN2 code and barring password. The codes can only include characters from 0 to 9. The phone asks you to key in the current code and the new code. It also asks you to confirm the new code by keying it in again.

Avoid using access codes similar to the emergency numbers, such as 112, to prevent accidental dialling of the emergency number.

Restore factory settings

You can reset some of the menu settings to their original values. The security code is needed for this function.



■ Games (Menu 5)







Note: Your phone must be switched on to use this function. Do not switch the phone on when wireless phone use is prohibited or when it may cause interference or danger.

Starting a game

1. Press **Menu**, select *Games* and then *Select game*.
2. Select either *Snake II*, *Space Impact*, *Bantumi*, *Pairs II* or *Bumper*.

Game options

- *New game* starts a new game session.
- *High scores* shows the highest scores.
- *Options* shows the game-specific options.
- *Instructions* shows a help text on how to play the game. Scroll through the text with  or .
- *Level* allows you to set the level of difficulty for the selected game. Scroll with  or  and press **OK**.
- *Continue* allows you to resume a paused game.

Game services and settings

1. Press **Menu** and select *Games*. Select either *Game services* or *Settings*.
 - By selecting *Game services*, the phone tries to connect to the WAP pages of Club Nokia using the currently active set of connection settings.

If the connection fails and an error message *Check service settings* is displayed, you may not be able to access Club Nokia from the WAP service whose connection settings are currently active. In this case, go to the *Services* menu and activate another set of connection settings, see Making a connection to a WAP service on page 89. Try again to connect to Club Nokia.
 - By selecting *Settings*, you can set the *Game sounds*, *Game lights* or *Shakes* (vibrating alert must be *On*) either on or off for the game and save your *Club Nokia id*.

■ Calculator (Menu 6)



The calculator in your phone adds, subtracts, multiplies, divides, and converts currency values.





Note: Your phone must be switched on to use this function. Do not switch the phone on when wireless phone use is prohibited or when it may cause interference or danger.

This calculator has a limited accuracy and rounding errors may occur, especially in long divisions.

Using the calculator

1. Press **Menu** and select *Calculator*.
2. When '0' is displayed on the screen, key in the first number in the calculation, press  for a decimal point.
3. Press **Options** and select *Add, Subtract, Multiply, Divide* or *Change sign*.

 **Tip:** Alternatively, press  once to add, twice to subtract, three times to multiply or four times to divide.

4. Key in the second number. Repeat steps 3 and 4 as many times as necessary. Press **Clear** to erase any mistakes.
5. For a total, press **Options**, scroll to *Equals* and press **OK**.

Making a currency conversion

1. Press **Menu** and select *Calculator*.
2. To set the exchange rate, press **Options**, scroll to *Exchange rate* and press **OK**.
3. Scroll to either of the displayed options and press **OK**. Key in the exchange rate (press  for a decimal point) and press **OK**.
4. To make the conversion, key in the amount to be converted, press **Options**, scroll to *In domestic* or *In foreign* and press **OK**.

■ Calendar (Menu 7)



The calendar helps you to keep track of reminders, meetings, birthdays, training events and calls that you need to make. The phone sounds an alarm tone when the set date for a birthday, reminder or a call expires. You can save up to 100 calendar notes in your phone's memory.



Note: Your phone must be switched on to use this function. Do not switch the phone on when wireless phone use is prohibited or when it may cause interference or danger.

Calendar options

1. Press **Menu** and select *Calendar*.
2. Scroll to the date you want and press **Options** to view the functions listed below. Select:
 - *View day notes* to view the notes set for the chosen day. Scroll through the note(s). If you have saved timed events to the calendar via stopwatch, you can view and edit them in the calendar but you cannot set an alarm for them. Stopwatch notes are indicated by the icon , see also Stopwatch on page 81.





By pressing **Options** while in a note allows access to the following functions: *Erase*, *Edit*, *Move*, *View by weeks*, *Send note*, *Send to many* and *Send via IR*.

Repeat to set a regular time period for the recurring note. The recurring note, for example every week, does not take more space in your phone's memory than a single note.

- *Make a note* to write a note, see Making a calendar note on page 77.
- *View by weeks* to view calendar showing two weeks at a time with week numbers, days and dates.
- *Erase notes* to delete the selected note(s). Scroll to one of the displayed options, *Of chosen day*, *One by one* or *All at once* and press **OK**.

- *View all notes* to view the notes that are set for all days. Scroll through the note(s). Pressing **Options** allows access to the same functions as *View day notes*. Scroll to the desired function and press **OK**.
- *Go to date* to go to the date you want.
- *Set the date* to change the current date.

Making a calendar note

1. Press **Menu** and select *Calendar*.
2. Scroll to the date you want and press **Options**.
3. Select *Make a note*, then select one of the following note items:
 - *Training* is indicated by the sport-specific icon, for example  for *Ice hockey*. Select an item from a list of sports. Key in a note and the date and time of training and press **OK**.
You can set the phone to sound a tone in anticipation for a note. When the phone asks *Set alarm for the note?*, press **Yes**, key in the alarm date and press **OK**. Repeat this with the alarm time. The tone alert is indicated by  when you view the notes.
 - *Reminder* is indicated by . Key in the note and the date and press **OK**.
 - *Call* is indicated by . Key in the desired phone number or search for it from phone book, and the date when the call should be made, press **OK**. Repeat this to set the time at which the call should be made.
 - *Meeting* is indicated by . Key in a note and the date of meeting, press **OK**. Repeat this to set the time of the meeting.

- *Birthday* is indicated by . Key in the person's name, the date of birth (include the year) and press **OK**. The note and the person's age will be shown in every coming year.

■ Infrared (Menu 8)



You can set up your phone to receive data through its infrared (IR) port. To use an IR connection, the device with which you want to establish a connection must be IrDA compliant. You can send and receive data such as business cards (names and phone numbers in the phone book) and calendar notes to and from the IR port of your phone.



Note: Your phone must be switched on to use this function. Do not switch the phone on when wireless phone use is prohibited or when it may cause interference or danger.

Sending and receiving data via the IR port



1. Ensure that the IR ports of the sending and receiving devices are pointing at each other and that there are no obstructions between the devices. The preferable distance between the devices is one meter at most.
2. To receive data to your phone, select the *Infrared* menu and press **Select** to activate the IR port.
3. The user of the sending phone selects the desired IR function to start data transfer.

If data transfer is not started within two minutes after the activation of the IR port, the connection is cancelled and will have to be started again.

Do not point the IR (infrared) beam at anyone's eye or allow it to interfere with other IR devices. This device is a Class 1 Laser product.

See also Sending and receiving a business card on page 36, Fax or data call on page 54 and Sending a note via IR in Calendar (Menu 7) on page 76.

IR connection indicator

- When  is displayed continuously, the IR connection is activated and your phone is ready to send or receive data via its IR port.
- When  blinks, your phone is trying to establish a connection with the other device or a connection has been lost.

■ Extras (9)



In the *Extras* menu you will find countdown timer, stopwatch and thermometer functions that you can use, for example, during sports activities. In addition, the menu includes a picture editor for creating, editing and saving pictures in the phone.

Countdown timer



Note: Your phone must be switched on to use this function. Do not switch the phone on when wireless phone use is prohibited or when it may cause interference or danger.

You can select either *Normal timer* to set time for simple tasks or *Interval timer* to save time periods of, for example, sports exercises. Both normal and interval timers can be restarted.

Setting the normal timer

1. Press **Menu**, select *Extras*, and *Countdown timer*.
2. Select *Normal timer*.
3. Key in the time in hours and minutes and press **OK**.

When the phone asks for the *Timer note*;, you can write your own note text which is displayed when the time expires.

To stop the countdown timer or change the time, press **Menu**, scroll to *Extras*, then to *Countdown timer*. Select *Stop timer* to set the timer to off or *Change time* to set the time as described above.

Setting the interval timers

When no interval timers have been saved:

1. Press **Menu**, select *Extras*, and then *Countdown timer*.
2. Select *Interval timer* and *Add new timer*.
3. At *Timer name*: key in the name and press **OK**. At *Period time*: key in the time in hours and minutes and press **OK**.

The name of the timer is shown when you view saved interval timers later.

At *Period note*;, you can write your own note text which is displayed when the time expires.

4. Press **Options** and select
Edit period to change the time of the current period.
Add period to add a new period for the timer after the currently selected period.

You can save up to 5 interval timers in the countdown timer memory. When the memory is full, the phone displays a list of interval timers. To delete one item from the list, press **Erase** and confirm with **OK**.

Erase period to delete the current period.

Start timer to start the timer. If you have saved several periods for one interval timer, the first period of the selected timer starts running.

When you have already saved interval timers in the phone's memory:

1. Press **Menu**, select *Extras*, and then *Countdown timer*.
2. Select *Interval timer*.

The phone displays a list of saved interval timers. By pressing **Options** you can access a submenu, where you can start, view, edit and erase a timer as well as add a new timer.

While the countdown timer is running, the icon  is shown in the standby mode.

Stopwatch

You can time an event, record splits or lap times using the stopwatch. During timing, the other functions of the phone are available.



Note: Your phone must be switched on to use this function. Do not switch the phone on when wireless phone use is prohibited or when it may cause interference or danger.

Using the stopwatch consumes the battery and the phone's operating time will be reduced. Be careful not to let it run in the background when performing other operations with your phone.

Timing and recording splits

1. Press **Menu**, select *Extras*, *Stopwatch* and *Split timing*.

You can select *Continue* if the timing was set in the background, for example, because of an incoming call.

2. Press **Start** to time an event. Press **Split** every time you want to record splits. The recorded splits are listed below the overall time on the display. Scroll to view the times.
3. Press **Stop** to finish timing.
4. Press **Options** and select

Start to continue timing from the previously timed event.

Save to save the time in the stopwatch memory or *Save to calend.* to save the time as a calendar note. Key in a name for the elapsed time and press **OK**. If no name is keyed in, the overall time is used as a title.

Reset to reset the time without saving it.

Lap times

1. Once in the *Extras* menu, select *Stopwatch* and *Lap timing*.
2. Press **Start** to time an event and **Lap** to record a lap time.
3. Press **Stop** to finish the lap timing.
4. Press **Options** and you can save or reset lap times. See Timing and recording splits above.

Viewing and erasing times

Press **Menu**, select **Extras** and **Stopwatch**. Select

- **Show last** to view the last timing. This option is shown only, if the stopwatch has not been reset
- **View times** to display the list of names or time sets saved in the stopwatch memory. By pressing **Options** you can select **Erase times** to delete the time or **Save to calend.** to save the recorded time in the calendar. You can view and edit the name and time of a stopwatch note in the calendar and send it as a stopwatch note to another compatible phone. See Calendar (Menu 7) on page 76.
- **Erase times** to delete the selected time(s). Scroll to one of the displayed options, **All at once** or **One by one** and press **OK**.

Thermometer

The thermometer in your phone is a fun feature providing you a means to measure the approximate temperature of your surroundings both in Celsius and Fahrenheit. The thermometer is not intended for professional use.



Note: Your phone must be switched on to use this function. Do not switch the phone on when wireless phone use is prohibited or when it may cause interference or danger.

1. Press **Menu**, select **Extras** and then **Thermometer**.
2. To get the best result, place the phone on a flat surface in a windless environment for the period of temperature measurement.



The temperature will flash until the measurement is ready. Both temperature values are rounded to the nearest whole number.

Picture editor

You can use picture editor to create, edit and save picture messages and clip-art or edit pictures already existing in the phone. You can also edit pictures in the *Picture messages* menu, see Picture messages on page 52.





Note: Your phone must be switched on to use this function. Do not switch the phone on when wireless phone use is prohibited or when it may cause interference or danger.







1. Press **Menu**, select *Extras* and then *Picture editor*. Select *Continue* to resume drawing process after, for example, an incoming call.
Create new to draw a new picture.
Edit existing to edit your own or existing pictures saved in the phone.
2. Select the picture format: *Picture msg.* or *Clip-art*.
3. Draw the picture and press *Save*.
If there is no space for a new picture, select one from the list of existing pictures and press **Replace**.
To save clip-art, scroll with  or  to find the location where you want to save the clip-art and press **Use**.

Drawing a picture

- **Pen:** You can draw with a pen that moves together with the cursor. Select *Pen on* to draw a line or *Pen off* to stop drawing. At *Pen off* you can move the cursor in the picture.



Tip: To quickly set the pen on or off, press  or .

- **Cursor:** You can move the cursor with the following number keys:  and  move the cursor up and down,  and  to left and right. The keys , , and  correspond to the four diagonal directions.

Press the corresponding number key once to move the cursor one pixel. To move the cursor continuously, press and hold the key down.

The centre of the cursor shows the actual colour of the pixel beneath. Pressing  changes the colour of the pixel from black to white or vice versa.

Drawing options

While drawing, select **Options** to view the following: *Colour*, *Insert*, *Fill*, *Clear all*, *Invert colours*, *Save as*, *Save*, *Undo*. Select

- *Colour* to change the colour of the line you are drawing. The options are *Black*, *White* or *Dotted*. You can also quickly change the colour by pressing .
- *Insert* to insert a line, rectangle, circle, text or clip-art in your picture. Select the option you want and press **Insert**. Use the number keys to draw a line, rectangle or circle.

Select *Fill* to fill the enclosed area with the currently selected colour. Move the cursor to the desired area, and press **Fill**. Select *Invert colours* to change the black pixels of the picture to white and vice versa or *Save as* to save the picture as a picture message or clip-art.



■ WAP services (Menu 10)

In this menu you can access various WAP (Wireless Application Protocol) services such as banking, online games, and entertainment. These services are specifically designed for mobile phones and they are maintained by WAP service providers.



Note: Your phone must be switched on to use this function. Do not switch the phone on when wireless phone use is prohibited or when it may cause interference or danger.

Check the availability of WAP services, pricing and tariffs with your network operator and/or the WAP service provider whose service you want to use. Service providers will also give you instructions on how to use their services.

The WAP services use Wireless Mark-up Language (WML) on their WAP pages. Web pages using the Hyper-Text Mark-up Language (HTML) cannot be viewed on your phone.

■ Basic steps for accessing and using a WAP service

1. Obtain the connection settings that are needed to access the WAP service that you want to use.
2. Save the connection settings.
See Setting up the phone for a WAP service on page 87 and Adjusting the appearance settings of WAP pages on page 92.
3. Make a call, that is a connection, to the given WAP service. See Making a connection to a WAP service on page 89.
4. Start browsing the pages of the WAP service. See Browsing the pages of a WAP service on page 90.
5. Once you are finished browsing, end the connection to the WAP service. See Ending a WAP connection on page 91.

Setting up the phone for a WAP service

You may obtain the connection settings as a text message from the network operator or service provider that offers the WAP service you want to use. For more information, contact your network operator or service provider or visit Club Nokia's Web site (www.club.nokia.com).

You can also key in the settings manually. For appropriate settings, contact your network operator or service provider. The WAP settings may be available, for example, on the Web site of the network operator or service provider.

Saving the connection settings received as a text message



When you receive the connection settings as a text message, *Service settings received* is displayed.

- To save and activate the received settings, press **Options** and select *Save*.
- To view the settings before saving them, press **Options** and select *View*.
Press **Back** to return to the option list and then press **Save**.

Keying in the connection settings manually

For appropriate settings, contact your network operator or service provider.

1. Press **Menu**, select *Services*, and then *Settings*.
2. Select *Connection settings*, scroll to a set of connection settings and press **Options**.
A set is a collection of settings needed for making a connection to a WAP service.
3. Select *Edit*, then scroll to each of the settings below. Key in all required settings one by one.
 - *Homepage*: Key in the homepage address of the WAP service that you want to use (press  for a period), and press **OK**.
 - *Session mode*: Select *Permanent* or *Temporary*.

- **Connection security:** Select *On* or *Off*.
When the connection security is *On*, the phone tries to use a secure connection with the WAP service. If no secure connection is available, the connection will not be made. If you wish to connect anyway, with a non-secure connection, set the connection security to *Off*.
 - **Data bearer:** Select *GSM data*. For pricing, connection speed and other information, contact your network operator or service provider.
 - **Dial-up number:** Key in the number and press **OK**.
 - **IP address:** Key in the address, press  for a period and press **OK**.
 - **Authentication type:** Scroll to *Secure* or *Normal* and press **Select**.
 - **Data call type:** Select *Analogue* or *ISDN*.
 - **Data call speed** - Select the speed you want to use, or select *Automatic*. *Automatic* is available only if the current selected data call type is *Analogue*. The actual data call speed depends on the service provider.
 - **User name:** Key in the user name (press  for a period) and press **OK**.
 - **Password:** Key in the password and press **OK**.
4. After you have made all the required settings, you can change the name of the settings group. Press **Back** and then **Options**, and select *Rename*, and press **Select**. Key in the name and press **OK**.
The settings are now saved and you can make a connection to the WAP service. See Making a connection to a WAP service on page 89.

■ Making a connection to a WAP service



Firstly, make sure that the connection settings of the WAP service you want to use are activated.

To activate the settings:

1. Press **Menu**, select *Services*, and then *Settings*.
2. Scroll to *Connection settings*, select the appropriate settings group and press **Options**.
3. Select *Activate*.

Secondly, make a connection to the WAP service. Select one of the three options:

- Open the homepage of the WAP service:
Press **Menu**, select *Services*, and then *Home*.

 **Tip:** In the standby mode you can quickly access the homepage of WAP service by pressing and holding .

- Select a bookmark of the WAP service:
Press **Menu**, select *Services*, and then *Bookmarks*. Scroll to the bookmark you want to use and press **Options**. Select *Go to*.

If the bookmark does not work with the current active service settings, *Check service settings* is displayed. Activate another set of connection settings and try again. Or:

- Key in the address of the WAP service:
Press **Menu**, select *Services*, and then *Go to address*. Key in the address (press  for special characters) of the WAP service and press **OK**.







Note that it is not necessary to add the prefix in front of the address, such as `http://`, since it will be added automatically. If you are using a protocol other than `http`, add the appropriate prefix.

Browsing the pages of a WAP service

Once you have made a connection to the WAP service, you can start browsing its WAP pages.

The function of the phone keys may vary in different WAP services. Follow the guiding texts on the display. For more information, contact your WAP service provider.

General guidelines for using the keys

- Use the scroll keys  or  to browse the WAP page and highlight the desired item.
- Press  to select a highlighted item.
- Press and hold  to disconnect from the WAP service and to end the call.
- Press  to  to enter letters and numbers and  to enter special characters.
- Some or all of the following options are available while a WAP connection is in progress. Press **Options** and select the option you want.

Home: Takes you back to the homepage of the WAP service.

Reload: Refreshes the WAP page.

Select: Selects a link or any other highlighted item on the WAP page.

Back: Takes you back to the last WAP page that you viewed.

Appearance settings: You can wrap the text lines and hide the images on the WAP page. For details, see Adjusting the appearance settings of WAP pages on page 92.

Bookmarks: You can manage bookmarks, for example, save the current WAP page as a bookmark. For details, see Managing bookmarks on page 92.

Service inbox - the list of service messages is displayed, see Service inbox on page 93.







Use number: Copies a number from the current WAP page for saving or calling, and ends the call. If the WAP page contains several numbers, you can select the desired one.

Go to address: You can make a connection to the desired WAP page. Key in the WAP address (press  for a period) and press **OK**.

Clear cache: Empties the cache memory of the phone, see The cache memory on page 94.

Security info: Shows whether the connection is secure.

Quit: Quits browsing and ends the call.

View picture: You can scroll a picture or animated picture that cannot be entirely shown on the display.  and  (or  and ) scroll the picture up or down.  and  scroll the picture left or right.

Press **Options** for the following: *Next picture*, *Prev. picture* or *Save picture*. With the *Save picture* option you can save pictures for use in picture messages or as screensavers, and animated pictures for use as screensavers. If the picture to be saved is too large for picture messages and screensavers, move the box shown over the picture to select the area that you want to save, and press **Select**.

Note that an animated picture saved from a WAP page cannot be used in picture messages.

■ Ending a WAP connection

When you are using a WAP service:

- Press **Options** and select *Quit*. When the text *Quit browsing?* is shown, press **Yes**.

The phone terminates the connection to the WAP service and ends the call.

■ Adjusting the appearance settings of WAP pages

1. Press **Menu**, select *Services* and then *Settings*.
2. Select *Appearance settings*.
3. Select either *Text wrapping* or *Show images*.
4. Select *On* or *Off* for *Text wrapping* and *Yes* or *No* for *Show images*.

When *Text wrapping* is set to *On*, the text continues on the next line if it cannot be shown on one line.

When *Show images* is set to *No*, pictures appearing on the WAP page are not shown. This may speed up the browsing of WAP pages that contain a lot of pictures.

■ Managing bookmarks

You can save WAP page addresses as bookmarks in the phone's memory.

1. When no WAP connection is in progress
 - Press **Menu**, select *Services*, and then *Bookmarks*.

When a WAP connection is in progress

 - Press **Options** and select *Bookmarks*.
2. Scroll to the bookmark you want to use and press **Options**.
 - *Add bookmark*: You can create a new bookmark without connection to a WAP service. Key in the address of the WAP page and press **OK**. Write a name for the WAP page and press **OK**.
 - *Go to*: to make a connection to the WAP page associated with the bookmark.
 - *Edit*: to modify the selected bookmark.

- *Erase*: to delete the selected bookmark.
- *Send bookm.*: to send the selected bookmark as a text message to another phone.

With the *Save bookm.* function you can save the current WAP page as a bookmark. Key in the address of the WAP page and press **OK**. Write a name for the WAP page and press **OK**.

Service inbox

The phone is able to receive service messages (pushed messages) sent by your service provider. Service messages are notifications of, for example, news headlines, and they may contain a text message or the address of a WAP service.

1. To access service inbox when no WAP connection is in progress

When you have received a service message, *1 service message received* will be displayed. Press **View** to access the *Service inbox*.

If you press **Exit**, the message is moved to the *Service inbox*. To access the *Service inbox* later, press **Menu**, select *Services*, and *Service inbox*.

When a WAP connection is in progress

Press **Options** and select *Service inbox*.

2. Scroll to the message you want and press **Options**.

Select *Download* to activate the WML browser and download the indicated content.

Select *Details* to display detailed information about the service notification.

Select *Erase* to delete the selected service notification.

To set the phone to receive service messages

Press **Menu**, select *Services*, *Settings*, *Service inbox settings* and *Service messages*. To set the phone to receive service messages, select *On*. If you select *Off*, the phone will not receive service messages.

■ The cache memory

The information or services that you have accessed are temporarily saved in the cache memory of the phone.



Note: The information or services you have accessed are stored in the cache of your phone. A cache is a buffer memory, which is used to store data temporarily. If you have tried to access or have accessed confidential information requiring passwords (for example, your bank account), empty the cache of your phone after each use.

To empty the cache:

- Press **Menu**, select *Services* and then *Clear cache*.

■ Authority certificates

For using some WAP services such as banking services, you need an authority certificate. Using the certificate can help you to improve the security of connections between your phone and a WAP gateway or WAP server, if the *Connection security* option is set to *On*.

You can download the certificate from a WAP page if the WAP supports the use of authority certificates. After the download, you can view the certificate and then save or delete it. If you save the certificate, it is added to the list of certificates in the phone.

You can only be sure that a WAP gateway or WAP server is the one it claims to be after its identity has been checked against the corresponding certificate in the phone.

You will see a note on the phone display if the identity of the WAP server or WAP gateway cannot be verified, the WAP server or WAP gateway certificate is not authentic or you do not have the right certificate in your phone.

Viewing the list of authority certificates:

1. Press **Menu**, select **Services**, and then **Settings**.
2. Select **Authority certificates**.

Security icon

If the security icon  is displayed during a WAP connection, the data transmission between the phone and the WAP gateway or WAP server (identified by the **IP address** setting in the **Connection settings**) is encrypted and secure.

However, the security icon does not indicate that the data transmission between the gateway and the content server (place where the requested resource is saved) is secure. It is up to the service provider to secure the data transmission between the gateway and the content server.

■ SIM services (Menu 11)

In addition to the functions available in the phone, your SIM card may provide additional services that you can access in Menu 11, SIM Services. Menu 11 is shown only if it is supported by your SIM card. The name and contents of the menu depend entirely on the services available.



Note: For availability, rates and information on using SIM services, contact your SIM card vendor, e.g. network operator, service provider or other vendor.

You can set the phone to display confirmation messages when you are using the SIM card services by selecting the option *Enabled* within *Confirm SIM service actions* in *Phone settings*.

Note that accessing these services may involve sending an SMS or making a phone call for which you may be charged.

7. Battery information

■ Charging and Discharging

Your phone is powered by a rechargeable battery.

Note that a new battery's full performance is achieved only after two or three complete charge and discharge cycles!

The battery can be charged and discharged hundreds of times but it will eventually wear out. When the operating time (talk-time and standby time) is noticeably shorter than normal, it is time to buy a new battery.

Use only batteries approved by the phone manufacturer and recharge your battery only with the chargers approved by the manufacturer. Unplug the charger when not in use. Do not leave the battery connected to a charger for longer than a week, since overcharging may shorten its lifetime. If left unused a fully charged battery will discharge itself over time.

Temperature extremes can affect the ability of your battery to charge.

Use the battery only for its intended purpose.

Never use any charger or battery which is damaged.

Do not short-circuit the battery. Accidental short-circuiting can occur when a metallic object (coin, clip or pen) causes direct connection of the + and - terminals of the battery (metal strips on the battery) for example when you carry a spare battery in your pocket or purse. Short-circuiting the terminals may damage the battery or the connecting object.

Leaving the battery in hot or cold places, such as in a closed car in summer or winter conditions, will reduce the capacity and lifetime of the battery. Always try to keep the battery between 15°C and 25°C (59°F and 77°F). A phone with a hot or cold battery may temporarily not work, even when the battery is fully charged. Batteries' performance is particularly limited in temperatures well below freezing.

Do not dispose of batteries in a fire !

Dispose of batteries according to local regulations (e.g. recycling). Do not dispose as household waste.

CARE AND MAINTENANCE

Your phone is a product of superior design and craftsmanship and should be treated with care. The suggestions below will help you to fulfil any warranty obligations and to enjoy this product for many years.

- Keep the phone and all its parts and accessories out of the reach of small children.
- Keep the phone dry. Precipitation, humidity and all types of liquids or moisture can contain minerals that will corrode electronic circuits.
- Do not use or store the phone in dusty, dirty areas. Its moving parts can be damaged.
- Do not store the phone in hot areas. High temperatures can shorten the life of electronic devices, damage batteries, and warp or melt certain plastics.
- Do not store the phone in cold areas. When it warms up (to its normal temperature), moisture can form inside, which may damage electronic circuit boards.
- Do not attempt to open the phone. Non-expert handling may damage it.
- Do not drop, knock or shake the phone. Rough handling can break internal circuit boards.
- Do not use harsh chemicals, cleaning solvents, or strong detergents to clean the phone.
- Do not paint the phone. Paint can clog the moving parts and prevent proper operation.
- Use only the supplied or an approved replacement antenna. Unauthorised antennas, modifications or attachments could damage the phone and may violate regulations governing radio devices.

All of the above suggestions apply equally to your phone, battery, charger or any accessory. If any of them is not working properly, take it to your nearest qualified service facility. The personnel there will assist you and, if necessary, arrange for service.

IMPORTANT SAFETY INFORMATION

■ Traffic Safety

Do not use a hand-held telephone while driving a vehicle. Always secure the phone in its holder; do not place the phone on the passenger seat or where it can break loose in a collision or sudden stop.

Remember road safety always comes first!

■ Operating environment

Remember to follow any special regulations in force in any area and always switch off your phone whenever it is forbidden to use it, or when it may cause interference or danger.

Use the phone only in its normal operating positions.

Parts of the phone are magnetic. Metallic materials may be attracted to the phone, and persons with a hearing aid should not hold the phone to the ear with the hearing aid. Always secure the phone in its holder, because metallic materials may be attracted by the earpiece. Do not place credit cards or other magnetic storage media near the phone, because information stored on them may be erased.

■ Electronic devices

Most modern electronic equipment is shielded from radio frequency (RF) signals. However, certain electronic equipment may not be shielded against the RF signals from your wireless phone.

Pacemakers

Pacemaker manufacturers recommend that a minimum separation of 20 cm (6 inches) be maintained between a handheld wireless phone and a pacemaker to avoid potential interference with the pacemaker. These recommendations are consistent with the independent research by and recommendations of Wireless Technology Research. Persons with pacemakers:

- Should always keep the phone more than 20 cm (6 inches) from their pacemaker when the phone is switched on;
- Should not carry the phone in a breast pocket;
- Should use the ear opposite the pacemaker to minimise the potential for interference.
- If you have any reason to suspect that interference is taking place, switch off your phone immediately.

Hearing aids

Some digital wireless phones may interfere with some hearing aids. In the event of such interference, you may want to consult your service provider.

Other medical devices

Operation of any radio transmitting equipment, including cellular phones, may interfere with the functionality of inadequately protected medical devices. Consult a physician or the manufacturer of the medical device to determine if they are adequately shielded from external RF energy or if you have any questions. Switch off your phone in health care facilities when any regulations posted in these areas instruct you to do so. Hospitals or health care facilities may be using equipment that could be sensitive to external RF energy.

Vehicles

RF signals may affect improperly installed or inadequately shielded electronic systems in motor vehicles (e.g. electronic fuel injection systems, electronic anti-skid (anti-lock) braking systems, electronic speed control systems, air bag systems). Check with the manufacturer or its representative regarding your vehicle. You should also consult the manufacturer of any equipment that has been added to your vehicle.

Posted facilities

Switch your phone off in any facility where posted notices so require.

■ Potentially explosive atmospheres

Switch off your phone when in any area with a potentially explosive atmosphere and obey all signs and instructions. Sparks in such areas could cause an explosion or fire resulting in bodily injury or even death.

Users are advised to switch off the phone when at a refuelling point (service station). Users are reminded of the need to observe restrictions on the use of radio equipment in fuel depots (fuel storage and distribution areas), chemical plants or where blasting operations are in progress.

Areas with a potentially explosive atmosphere are often but not always clearly marked. They include below deck on boats; chemical transfer or storage facilities; vehicles using liquified petroleum gas (such as propane or butane); areas where the air contains chemicals or particles, such as grain, dust or metal powders; and any other area where you would normally be advised to turn off your vehicle engine.

■ Vehicles

Only qualified personnel should service the phone, or install the phone in a vehicle. Faulty installation or service may be dangerous and may invalidate any warranty which may apply to the unit.

Check regularly that all wireless phone equipment in your vehicle is mounted and operating properly.

Do not store or carry flammable liquids, gases or explosive materials in the same compartment as the phone, its parts or accessories.

For vehicles equipped with an air bag, remember that an air bag inflates with great force. Do not place objects, including both installed or portable wireless equipment in the area over the air bag or in the air bag deployment area. If in-vehicle wireless equipment is improperly installed and the air bag inflates, serious injury could result.

Using your phone while in the air is prohibited. Switch off your phone before boarding an aircraft. The use of wireless telephones in an aircraft may be dangerous to the operation of the aircraft, disrupt the wireless telephone network and may be illegal.

Failure to observe these instructions may lead to suspension or denial of telephone services to the offender, or legal action or both.

■ Emergency calls





Important:

This phone, like any wireless phone, operates using radio signals, wireless and landline networks as well as user-programmed functions. Because of this, connections in all conditions can not be guaranteed. Therefore you should never rely solely upon any wireless phone for essential communications (e.g. medical emergencies).

Emergency calls may not be possible on all wireless phone networks or when certain network services and/or phone features are in use. Check with local service providers.

To make an emergency call:

1. If the phone is not on, switch it on. Check for adequate signal strength.
Some networks may require that a valid SIM card is properly inserted in the phone.
2. Press  as many times as needed (e.g. to exit a call, to exit a menu, etc.) to clear the display and ready the phone for calls.
3. Key in the emergency number for your present location (e.g. 112 or other official emergency number).
Emergency numbers vary by location.
4. Press the  key.

If certain features are in use, you may first need to turn those features off before you can make an emergency call. Consult this guide and your local cellular service provider.

When making an emergency call, remember to give all the necessary information as accurately as possible. Remember that your wireless phone may be the only means of communication at the scene of an accident - do not cut off the call until given permission to do so.

■ Certification information (SAR)

THIS MODEL PHONE MEETS THE EU REQUIREMENTS FOR EXPOSURE TO RADIO WAVES.

Your mobile phone is a radio transmitter and receiver. It is designed and manufactured not to exceed the limits for exposure to radiofrequency (RF) energy recommended by The Council of the European Union. These limits are part of comprehensive guidelines and establish permitted levels of RF energy for the general population. The guidelines were developed by independent scientific organisations through periodic and thorough evaluation of scientific studies. The limits include a substantial safety margin designed to assure the safety of all persons, regardless of age and health.

The exposure standard for mobile phones employs a unit of measurement known as the Specific Absorption Rate, or SAR. The SAR limit recommended by The Council of the European Union is 2.0 W/kg.* Tests for SAR have been conducted using standard operating positions with the phone transmitting at its highest certified power level in all tested frequency bands. Although the SAR is determined at the highest certified power level, the actual SAR level of the phone while operating can be well below the maximum value. This is because the phone is designed to operate at multiple power levels so as to use only the power required to reach the network. In general, the closer you are to a base station antenna, the lower the power output.

Before a phone model is available for sale to the public, compliance with the European R&TTE directive must be shown. This directive includes as one essential requirement the protection of the health and the safety for the user and any other person. The highest SAR value for this model phone when tested for compliance against the standard was 0.62 W/kg. While there may be differences between the SAR levels of various phones and at various positions, they all meet the EU requirements for RF exposure.

* The SAR limit for mobile phones used by the public is 2.0 watts/kilogram (W/kg) averaged over ten grams of tissue. The limit incorporates a substantial margin of safety to give additional protection for the public and to account for any variations in measurements. SAR values may vary depending on national reporting requirements and the network band. For SAR information in other regions please look under product information at www.nokia.com.

LIMITED MANUFACTURER'S WARRANTY

PART OF EUROPE & AFRICA REGION

This limited warranty shall apply in part of Nokia Mobile Phones' Europe & Africa Region unless a local warranty exists. Nokia Corporation, Nokia Mobile Phones ("Nokia") warrants that this NOKIA product ("Product") is at the time of its original purchase free of defects in materials, design and workmanship subject to the following terms and conditions:

1. This limited warranty is given to the end-purchaser of the Product ("Customer"). It shall neither exclude nor limit i) any mandatory statutory rights of the Customer or ii) any of the Customer's rights against the seller/dealer of the Product.
2. The warranty period is twelve (12) months from the date on which the first Customer purchased the Product. In case of a subsequent purchase or other change of owner/user, such warranty period shall continue for the remaining part of the twelve (12) month period and otherwise remain unaffected. This limited warranty is only valid and enforceable in the following countries: Bosnia, Bulgaria, Croatia, Cyprus, the Czech Republic, Estonia, any member state of the European Union, Hungary, Iceland, Israel, Latvia, Lithuania, Macedonia, Malta, Norway, Poland, Romania, the Slovak Republic, Slovenia, Switzerland and Turkey.
3. During the warranty period Nokia or its authorized service company will repair or replace, at Nokia's sole discretion, a defective Product. Nokia will return the repaired Product or another Product to the Customer in good working condition. All parts or other equipment for which replacements have been provided shall become the property of Nokia.
4. A repaired or replaced Product will not be given a prolonged or renewed warranty period.
5. This limited warranty will not cover painted covers or other similar personalized parts. In all cases that require unlocking or locking of an operator SIM-lock, Nokia will first direct the Customer to such operator for unlocking or locking of the operator SIM-lock before repairing or replacing the Product.
6. This limited warranty shall not apply to deterioration due to normal wear and tear. This limited warranty shall further not apply if:

(i) the defect was caused by the fact that the Product has been subjected to: use in contradiction with the owner's/user manual, rough handling, exposure to moisture, dampness or extreme thermal or environmental conditions or rapid changes in such conditions, corrosion, oxidation, unauthorized modifications or connections, unauthorized opening or repair, repair by use of unauthorized spare parts, misuse, improper installation, accident, forces of nature, spillage of food or liquid, influence from chemical products or other acts beyond the reasonable control of Nokia (including but not limited to deficiencies in consumable parts, such as batteries

which all by their nature have a limited lifetime, and breakage or damage to antennas) unless the defect was caused directly by defects in materials, design or workmanship;

- (ii) Nokia or its authorized service company was not notified by the Customer of the defect within thirty (30) days after the appearance of the defect within the warranty period;
 - (iii) the Product was not returned to Nokia or its authorized service company within thirty (30) days after the appearance of the defect within the warranty period;
 - (iv) the Product serial number, the accessory date code or the IMEI number has been removed, erased, defaced, altered or is illegible;
 - (v) the defect was caused by a defective function of the cellular network;
 - (vi) the defect was caused by the fact that the Product was used with or connected to an accessory not manufactured and supplied by Nokia or used in other than its intended use;
 - (vii) the defect was caused by the fact that the battery was short-circuited or seals of the battery enclosure or cells were broken or show evidence of tampering or the battery was used in equipment other than for which it has been specified; or
 - (viii) the Product software needs to be upgraded due to changes in cellular network parameters.
7. To claim this limited warranty the Customer shall present either i) a legible and non-modified original warranty card which clearly indicates the name and address of the seller, the date and place of purchase, the product type and the IMEI or other serial number or alternatively ii) a legible and non-modified original purchase receipt which contains the same information, if such purchase receipt is presented to the seller/dealer of the Product.
 8. This limited warranty is the Customer's sole and exclusive remedy against Nokia and Nokia's sole and exclusive liability against the Customer for defects or malfunctions of the Product. This limited warranty replaces all other warranties and liabilities, whether oral, written, (non-mandatory) statutory, contractual, in tort or otherwise. Nokia is in no event liable for any incidental, consequential or indirect damage, costs or expenses. Neither is Nokia in any event liable for any direct damage, costs or expenses, if the Customer is a legal person.
 9. Any change or amendment to this limited warranty requires Nokia's prior written consent.

WARRANTY CARD

FILL IN WITH BLOCK LETTERS

Purchaser's Name: _____

Address: _____

Country: _____

Phone: _____

Date of Purchase (dd/mm/yy): [] [] / [] [] / [] []

Product Type (on phone type label under battery): [] [] [] - [] [] []

Product Model (on phone type label under battery): [] [] [] []

Phone Serial No (on phone type label under battery):

[] [] [] [] [] [] / [] [] / [] [] [] [] [] [] [] [] [] [] []

Place of Purchase: _____

Store Name: _____

Store Address: _____



ITEM:
IMEI:

B

Stamp