

# Panasonic

Operating Instructions Part 1  
Digital Cellular Phone

## A500

EB-A500  
Mobile Phone

GSM



*Before operating this equipment  
please read these instructions  
(parts 1 and 2) completely.  
Charge battery before operation*

<b>Getting Started</b> .....	<b>1</b>	<b>Messages Menu Structure</b> .....	<b>36</b>
Inserting and removing the SIM .....	1	<b>Messages</b> .....	<b>37</b>
Attaching and removing the battery .....	1	MMS (Multimedia Messaging Service) .....	37
Charging the battery .....	2	SMS (Short Message Service) .....	43
Operation of battery level indicator .....	2	Voicemail .....	47
Low battery power warning .....	2	Chat .....	47
<b>Keys &amp; Displays</b> .....	<b>3</b>	Cell Broadcast .....	48
Keys .....	4	Memory status .....	48
Shortcuts .....	5	<b>Contacts Menu Structure</b> .....	<b>49</b>
Illumination light .....	5	<b>Contacts</b> .....	<b>50</b>
Display .....	6	Browsing Contacts .....	50
<b>How to Use This Phone</b> .....	<b>7</b>	Storing .....	51
Selecting a menu option .....	7	Call log .....	53
Symbols used in this manual .....	8	Speed dial .....	54
<b>Phone Basics and Managing Calls</b> .....	<b>9</b>	Grouping Contacts entries .....	55
Switching phone ON/OFF .....	9	My Number .....	56
Displaying menu .....	9	Group settings .....	57
Making calls .....	9	Memory status .....	57
Answering calls .....	10	Copy from SIM .....	57
Ending/rejecting calls .....	10	Service numbers .....	57
Voicemail .....	11	<b>Browser Menu Structure</b> .....	<b>58</b>
Activating Quiet mode .....	11	<b>Browser</b> .....	<b>59</b>
In-call options .....	12	Server setting .....	59
Call log .....	15	Viewing the contents .....	59
<b>Explore the Menus</b> .....	<b>17</b>	Browser options .....	60
<b>Settings Menu Structure</b> .....	<b>18</b>	Browser options (Bookmarks) .....	60
<b>Settings</b> .....	<b>19</b>	Browser options (Enter address) .....	61
Tone setting .....	19	Browser options (Save image) .....	61
Vibration Alert setting .....	20	Browser options (Set as bookmark) .....	61
Display setting .....	21	Browser options (Service Inbox) .....	61
Language setting .....	22	Browser options (Reload page) .....	62
Data connections setting .....	22	Browser options (Advanced) .....	62
Network setting .....	22	Browser options (Settings) .....	63
Call settings .....	24	<b>Games Menu Structure</b> .....	<b>64</b>
Security settings .....	27	<b>Games</b> .....	<b>65</b>
Time and date setting .....	29	Selecting games .....	65
Any key answer setting .....	29	Downloading games .....	65
Keyguard setting .....	30	Settings .....	66
<b>Profiles Menu Structure</b> .....	<b>31</b>	<b>Applications Menu Structure</b> .....	<b>67</b>
<b>Profiles</b> .....	<b>32</b>	<b>Applications</b> .....	<b>68</b>
Profile setting .....	32	STK (SIM Tool Kit) .....	68
Editing profile .....	32	Alarm .....	68
<b>Text Entry (Edit)</b> .....	<b>34</b>	Sound recorder .....	69
Shift mode .....	34	Calculator .....	69
Input mode .....	35	Infrared .....	70
Text input .....	35	<b>Calendar</b> .....	<b>72</b>

<b>My Media Menu Structure</b> .....	<b>73</b>
<b>My Media</b> .....	<b>74</b>
Pictures (My Media > Pictures).....	74
Sounds (My Media > Sounds) .....	75
Shortcuts.....	76
Text templates .....	76
Memory status .....	77
<b>Personal WAP/MMS Settings</b> .....	<b>78</b>
<b>Troubleshooting</b> .....	<b>80</b>
Important error messages.....	81
<b>Glossary of Terms</b> .....	<b>82</b>
<b>How to Change the X Changeable Cover</b> .....	<b>83</b>
<b>Index</b> .....	<b>84</b>

Some services described in this manual are network dependent or may only be available on a subscription basis. Some functions are SIM dependent. For more information contact your service provider.

## Inserting and removing the SIM

The SIM is inserted into the back of the phone.  
(See "Attaching and removing the battery" below to remove or attach the battery.)

### Inserting the SIM

Slide your SIM card (with the gold contacts facing downwards) into its holder, making sure that the cutout corner is aligned.

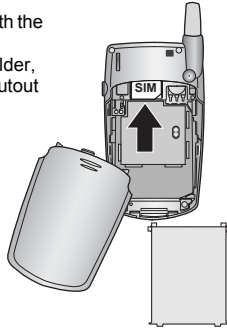

### Removing the SIM

Slide out the SIM.

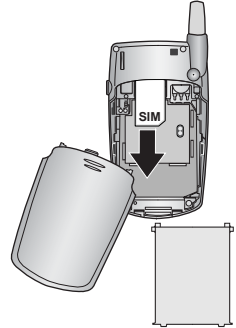

**NOTE** If you are upgrading your phone and your previous phone did not support new services, such as MMS (Multi Media Messaging), you may need to insert a new SIM. Contact your service provider.

## Attaching and removing the battery

Before removing the battery, ensure that the phone is switched off and the charger is disconnected from the phone.

### Attaching the battery

- 1 Insert the battery, ensuring the 3 gold contacts align with the 3 gold pins in the phone.
- 2 Replace cover on the phone and slide upwards to the top of the phone.

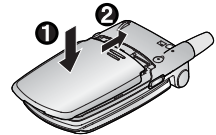
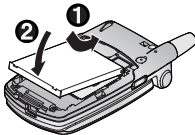

### Removing the battery

- 1 Press top part of the cover and remove.
- 2 Lift the battery out.

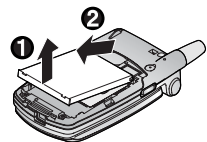
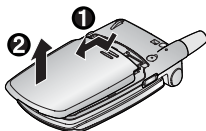

## Charging the battery

### Connecting and disconnecting the Fast Travel Charger

The battery must be attached in the phone before the charger is connected.

Do not force the connector as this may damage the phone and/or the charger.

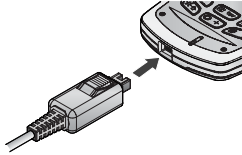

Connect the charger to the mains power supply. When the phone is charging, the charging indicator will light and a scrolling icon will appear in the main display.

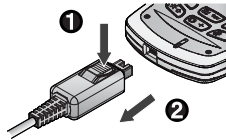

When charging is complete switch off the mains power supply and disconnect the charger by pressing the button ❶ and remove from the base of the phone ❷.



## Operation of battery level indicator

While charging	Charging complete
	

Charging Indicator will go out when charging is completed.







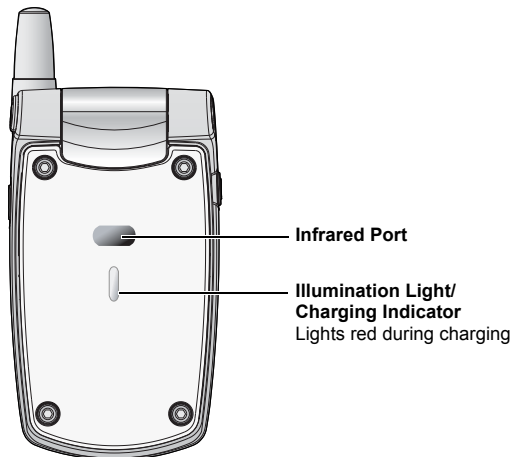









## Low battery power warning

When the battery power is low, a warning tone will sound and a **Battery low** message will be displayed. Charge the battery, or the phone will be switched off in 2 minutes. (See “Charging the battery” above.) Calls can be made and received while the phone is charging.

Some settings may be lost if the battery is removed or remains discharged for more than 1.5 hours.









## Keys



Key	Function
	<b>Navigation key:</b> Select and save settings, and scroll/move through menus, text and Contacts. Also controls movements while playing games.
	 <b>Select key:</b> Press centre to select option or to save. <b>Keyguard key:</b> From Idle mode, press and hold to lock the keypad, or press to unlock the keypad. <b>Alert Mute key:</b> Turns ring tone off and stops vibration when receiving a call (Alert mute).
	 <b>Scroll key:</b> Press top or bottom edge to move screen cursor up or down.
	 <b>Move key:</b> Press left or right edge to move screen cursor left or right.
	<b>Left Soft key:</b> Perform function displayed in lower left corner of the display. From Idle mode, press to open Messages menu.
	<b>Right Soft key:</b> Perform function displayed in lower right corner of the display. Mainly used to cancel and return to previous menu level or to delete text/number entries. Press and hold to delete all characters in text entry mode. From Idle mode, press to open Browser menu.
	<b>Send key:</b> Make a call, recall recently dialled phone numbers or answer a call.
	<b>Power/End key:</b> Press and hold to switch phone on/off. When the phone is on, press briefly to end a call. During key operation, press to return to Idle mode.
 to 	<b>1 key/Voicemail key:</b> Press and hold  to retrieve voicemail messages. <b>1-9 Number keys:</b> Enter numbers. Press and hold a single key (2-9) for Speed dial. In text entry mode, enter text, numbers and characters.
	<b>0 Number key:</b> Enter number. In text entry mode, enter number and characters. <b>International Dialling Prefix key:</b> Press and hold  to enter + (the international dialling prefix) while entering a phone number.
	<b>Asterisk key:</b> During text entry mode, press to switch between upper case and lower case letters. Changes Input mode (Hold).
	<b>Pause key:</b> Press and hold to enter a pause (P) while entering a phone number. In text entry mode, press to enter a space. Press and hold to enter a line feed. <b>Quiet Mode key:</b> From Idle mode, press and hold to turn Quiet profile on/off.
	<b>Alert Mute key (located on the left side of the phone):</b> Turns ring tone off and stops vibration when receiving a call (Alert mute).

## Shortcuts





When you are familiar with the menu system, you can use the keypad to access features instead of navigating through the display menus.

### Short press (from Idle mode)

Key	Function
 or 	Messages
 or 	Browser
	Menu/Alert mute/ Keypad off
	Shortcuts
	Contacts

Key	Function
	Call dial field
	Dialled numbers
	Alert mute

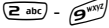
### Long press (from Idle mode)

Key	Function
	Keypad on
	Voicemail
	Speed dial
	Quiet mode on/off

## Illumination light

Function	Luminous colour	Light goes out
Incoming call	Purple	if call is missed (Yellow) or switched over to voice call (Blue)
Call in progress	Blue	if call ended
Missed call notification	Yellow	Mobile phone status: Closed if phone is opened or the Alert Mute key is pressed Mobile phone status: Open if phone is closed or any key is pressed
Message notification (SMS or MMS or WAP Push)	Green	Mobile phone status: Closed if phone is opened or the Alert Mute key is pressed Mobile phone status: Open if phone is closed or any key is pressed
Alarm notification	Red	after alarm is ended (30 seconds) or any key is pressed



## Display



With some operations, the display automatically clears after 2.5 seconds or after pressing any key.

### Status icons

Different icons are shown, depending on the features you are using and the options you have selected. Icons appear on the main display as shown in the following table.

Icon	Meaning
	Signal strength The more bars visible, the stronger the signal.
	Battery charge level
	Battery is charging
	GPRS is active
	Quiet profile is active
	Meeting profile is active
	Outdoor profile is active

Icon	Meaning
	Car profile is active
	SMS message storage area is full
	MMS message storage area is full
	Java™ (Suspended)
	Unread SMS message
	Unread MMS message
	Unread WAP push message
	Call Diverts is on
	Infrared is active
	New voicemail message received
	Incoming Volume 0
	Vibration Alert is on
	Alarm is set
	On-line browsing during CSD (Non-Secure)
	On-line browsing during CSD (Secure)
	On-line browsing during GPRS (Non-Secure)
	On-line browsing during GPRS (Secure)
	Keyguard is on















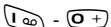

## Selecting a menu option

From Idle mode, press the centre of the Navigation key  to open the main menu display. The main menu display has 9 options.



## Symbols used in this manual

The table below shows the symbols used throughout these instructions and the corresponding meanings in the column on the right.

Symbol	Meaning
	Press centre of the Navigation key to select option or to save
	Direction in which you can move on the display screen with the Navigation key
	Shows possibility of moving in any direction (up, down, left and right) on the display screen with the Navigation key
	Shows possibility of moving up and down on the display screen with the Navigation key
	Shows possibility of moving left and right on the display screen with the Navigation key
	Press Left Soft key
	Press Right Soft key
	Press centre of Navigation key or Left Soft key
	Press Number keys
	Press Asterisk key
	Press Pause key / Quiet Mode key
	Press Send key
	Press Power / End key
	Indicates that a function is SIM dependent
	Indicates that a function is network dependent
	Press Alert Mute key

# Phone Basics and Managing Calls



## Switching phone ON/OFF

Press and hold  for 3 seconds to switch phone on

- When the phone is switched on, a greeting may be displayed and the phone enters Idle mode.

Press and hold  again to switch phone off



When switching the phone off, use only  to avoid damaging the phone.

## Displaying menu







- 1 To access the menu, press  in Idle mode
- 2 The menu will be displayed  
(The menu may vary depending on your SIM.)





## Making calls

- To make a call, start in Idle mode.
- Ensure network name and  appear on the display.





### Standard dialling

- 1 Enter phone number ( - , , )
- 2  / 

### Contacts dialling

- 1  **Contacts** (see "Shortcuts" on page 5)
- 2  required contact 



### Recent number dialling (Calls made or received)

- 1 
- 2  **Dialled numbers, Answered calls or Missed calls**
- 3  required contact 



## International dialling

The international code for the destination country/region should be entered, followed by the area code and phone number.



- 1 Press and hold 
- 2 Enter country/region code
- 3 Enter area code and phone number  / 

**NOTE** Many countries/regions include an initial "0" in the area code. This should, in most cases, be omitted when dialling international numbers. If you have difficulties making international calls, contact your service provider.



## Emergency call

To make an emergency call, the antenna () must be present.

### When SIM is inserted:

Enter emergency number 112  / 

### When SIM is not inserted:

Enter emergency number 112  /  / 



or

- 1 
- 2  SOS  / 



Most countries support the international emergency number 112. If you find the number does not work on your phone, please call your service provider. Making emergency calls without a SIM is country or network operator dependent.

## Answering calls

Press any key except  /  /  /  (Any key answer)

**NOTE** Any key answer can be disabled. (See "Any key answer setting" on page 29.) In this case, calls can only be answered by pressing  or .

## Ending/rejecting calls

 /  or fold the phone during an incoming call to reject the call or end a call in progress.



## Voicemail

You need to subscribe to the voicemail service through your service provider before you can retrieve voicemail messages. To check if voicemail access has been configured, press and hold **1 00**. See "Voicemail" on page 47 on how to programme.

1 When a new voicemail message is received, an alert sounds and **1 00** appears in lower part of the display or you receive an SMS notification (depending on the local service)

- **1 00** remains on the display until you have listened to all your voice messages.

2 Press and hold **1 00** to automatically dial your voicemail number

- If the number is not valid, contact your service provider.

3 Follow the recorded instructions for your voicemail

4 **End Call** when finished

## Activating Quiet mode

1 To quickly set the phone to your preset Quiet mode settings, press and hold **# \***

- To change Quiet mode settings, see "Editing profile" on page 32.

2 To disable, press and hold **# \*** again

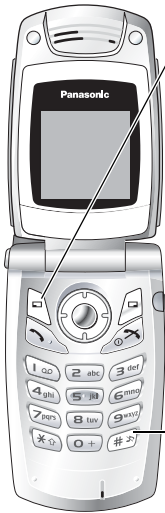

## In-call options

During a call: for options  
 required option /

Option	Explanation
Hold Call	Put a call on hold. To resume, , <b>Resume</b> /
From Contacts	Access the Contacts list
Create SMS	Access Create SMS
Inbox (SMS)	Access Inbox (SMS)
Calendar	Access Calendar
Handsfree / Handheld	Switch to Desktop Handsfree or Handheld

### Earpiece volume

During a call: / to adjust earpiece volume

### Desktop Handsfree

Desktop Handsfree allows you to have a conversation without holding the phone to your ear.

#### Swapping between Handsfree and Handheld calls:

During a Handheld call:

, **Handsfree** /

During a Handsfree call:

, **Handheld** /

Do not hold the phone to your ear in Handsfree mode.

### DTMF tones

DTMF tones can be sent during a conversation. These are often used to access voicemail, paging and computerised home banking. For example, you may need to input a number to remotely access voicemail messages. A phone number may be stored in Contacts together with a DTMF tone sequence, allowing the number to be dialled upon recall and the DTMF tone sequence to be sent automatically.

#### Send DTMF tones during a call:

Press digits + - , ,

#### Pause dial:

Using pauses allows you to send DTMF tones automatically.

- 1 Enter phone number
- 2 Press and hold until a P is displayed at the end of the phone number entered
- 3 Enter the DTMF digits after the pause, e.g. enter the number to access voicemail messages
- 4 /

When the call is connected the DTMF tone sequence will be sent after 3 seconds.



### Incoming call while on a call

During a call, you may receive another call. To enable this, Call Waiting must be on. (See "Call Waiting" on page 25.)

#### Accept a second call:

/ (The second call is active, the current call is put on hold)

When two calls are connected, the following options are available by pressing .

required option /

Option	Explanation
Swap	Switch between two connected calls
Merge	Enable multi-party conversation when two calls are connected (one active, one on hold). All three parties can then talk to each other
From Contacts	Access the Contacts list
Create SMS	Access Create SMS
Inbox (SMS)	Access Inbox (SMS)
Calendar	Access Calendar
Handsfree / Handheld	Switch to Desktop Handsfree or Handheld

#### Reject a second call:

to reject the incoming call and to resume the call in progress.

#### End current call and receive second call:

to end the call in progress, then press any key except / / / to answer the incoming call.

Call Waiting is network dependent ( ).

### Making a second call

#### During a call:

Enter second phone number and /

or

for options and select required contact from the Contacts list and

- The first call is put on hold.

Making a second call is network dependent ( ).





## Multi-party call

A multi-party call has 3 or more people in conversation at the same time. (📞)

- 1 Establish a multi-party call by merging two calls
- 2 Continue to add people to the multi-party call (up to 5 connections in total) by calling others or by accepting incoming calls

When making a call or accepting an incoming call, the multi-party call is placed on hold. The callers already in the multi-party call can continue to talk with each other while on hold. Each additional connection can then be merged into the multi-party call by 📞, Ⓜ Merge ● / 📞.

### Multi-party call options

You can select an individual from the multi-party call and split the conversation, allowing you to talk privately without the participation of the rest of the parties in the multi-party call.

- 1 During a multi-party call, 📞
- 2 Ⓜ **Option** ● / 📞
- 3 📞 desired caller in the multi-party list
- 4 desired option 📞
- 5 📞 required option ● / 📞

Option	Explanation
Split	Split the selected caller from the multi-party call so you can talk privately. The remaining multi-party callers are placed on hold and can still talk with each other. To rejoin the call, 📞, Ⓜ Merge ● / 📞
Ok	Close the options list

To end the call's connection, 📞 (End)

- 6 📞 to end the multi-party call and all connections



## Call log

Recently dialed phone numbers, answered calls and missed calls are stored in the Call log. The numbers in the Call log list can be used to call, send messages or add to Contacts. You can also delete the numbers from the list.

### Viewing Call log

- 1
- 2 **Dialled numbers, Answered calls or Missed calls**
- 3 required phone number

### Dialling from Call log

- 1
- 2 **Dialled numbers, Answered calls or Missed calls**
- 3 required phone number
- 4
- 5 **Call** /

### Sending messages

- 1
- 2 **Dialled numbers, Answered calls or Missed calls**
- 3 required phone number
- 4
- 5 **Send message** /
- 6 **MMS or SMS** /
- 7 Enter a message

For details on creating a message, see “Creating a new MMS” on page 37 or “Creating a text message” on page 43.



## Saving a phone number from Call log into the Contacts list

- 1
  - 2 **Dialled numbers, Answered calls or Missed calls**
  - 3 required phone number
  - 4
  - 5 **Add to contacts** /
  - 6 **Phone or SIM** /
  - 7 required icon
  - 8 Enter as appropriate
- (If required, repeat steps 7 and 8)
- 9

## Options in Call log

In each Call log list, the following options are available by pressing .

- required option /

Option	Explanation
Call	Call selected number
Send message	Send MMS/SMS message to selected number
Add to contacts	Store number to Contacts
Delete	Delete selected log
Delete all	Delete all logs in the list (This option is available in the Call log list.)

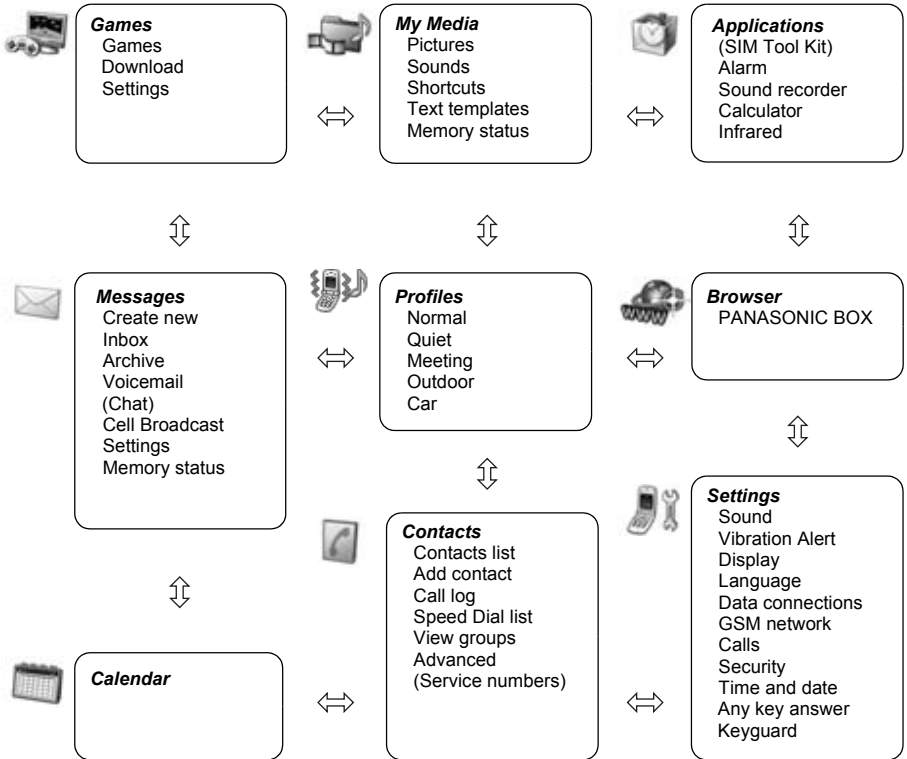

SIM Tool Kit and Service numbers are SIM dependent (SIM icon).  
 Chat is network operator dependent.

# Settings Menu Structure

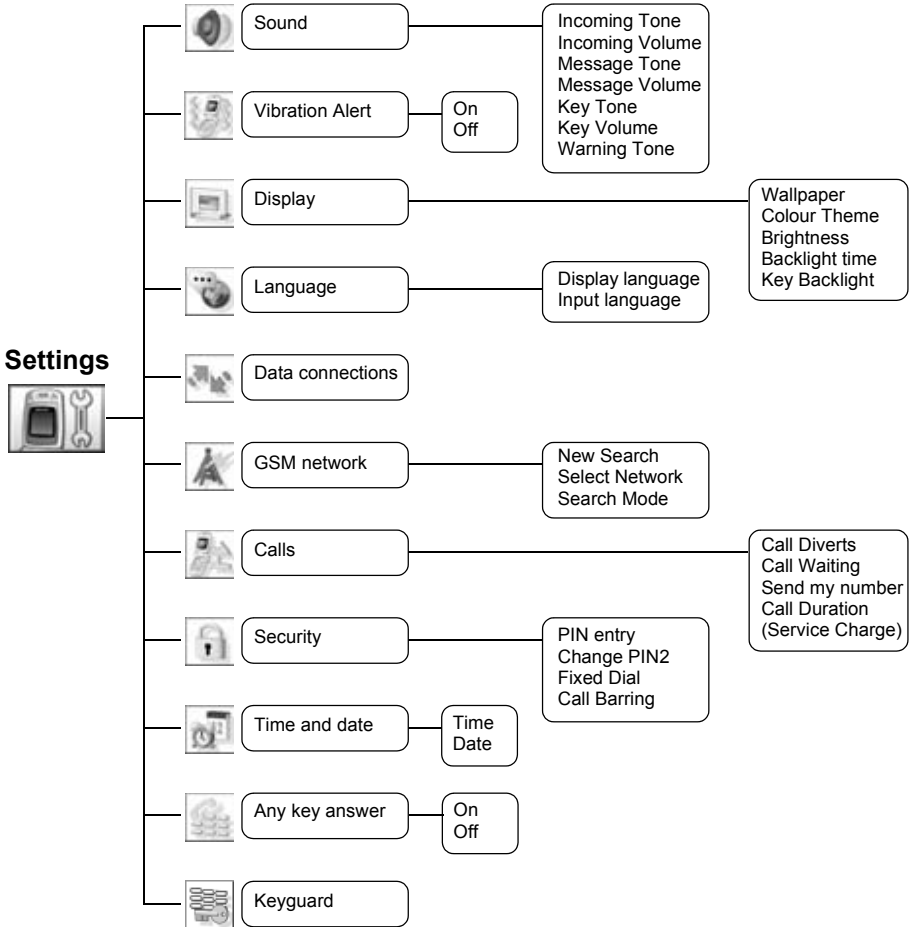

Service Charge is SIM dependent (☐).

# Settings



## Sound



### Tone setting

You can set ring tone, ring volume, etc.

The ring tone can be changed to one of the tones from **Preinstalled**, **My Media** or **Download**. Incoming tone and Message tone can have different ring tones and volume assigned.

Ring volume increases in steps to the level you selected. Keep in mind that the speaker located next to the receiver may sound too loud when the phone is held to your ear.

#### Changing Incoming Tone

From **Sound** menu

- 1 Incoming Tone /
- 2 Preinstalled, My Media or Download /
- 3 required data /



#### Setting Incoming Volume

From **Sound** menu

- 1 Incoming Volume /
- 2 / adjust the volume level (0 - 4) /



#### Changing Message Tone

From **Sound** menu

- 1 Message Tone /
- 2 Preinstalled, My Media or Download /
- 3 required data /



#### Setting Message Volume

From **Sound** menu

- 1 Message Volume /
- 2 / adjust the volume level (0 - 4) /



#### Setting Key Tone

From **Sound** menu

- 1 Key Tone /
- 2 required tone /

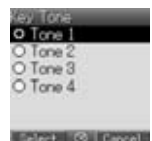

# Settings



## Sound



## Vibration Alert



### Setting Key Volume

From Sound menu

- 1 **Key Volume**  /
- 2 / adjust the volume level (0 - 4)  /



### Setting Warning Tone

From Sound menu

- 1 **Warning Tone**  /
- 2 **On or Off**  /



### Vibration Alert setting

Vibration Alert can be set to indicate an incoming call and a received message.

From Vibration Alert menu

- 1 **On or Off**  /



# Settings



## Display



Display Colour, Brightness, Wallpaper, Backlight time and Key Backlight can be changed.

## Display setting

### Setting Wallpaper

From **Display** menu

- 1 **Wallpaper** /
- 2 **Preinstalled, My Media or Download** /
- 3 required data
- 4 To view and save, press then / to save  
or  
To save without viewing, press

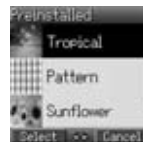

### Setting Display Colour Theme

From **Display** menu

- 1 **Colour Theme** /
- 2 required colour /



### Setting Display Brightness

From **Display** menu

- 1 **Brightness** /
- 2 adjust the brightness level (1 - 5) /

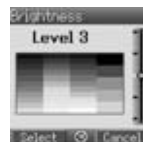

### Setting Backlight time

From **Display** menu

- 1 **Backlight time** /
- 2 required time /

The backlight goes out, then display is turned off in 1 minute.

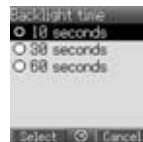

### Setting Key Backlight

From **Display** menu

- 1 **Key Backlight** /
- 2 **On or Off** /

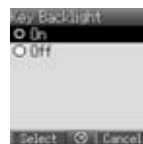



# Settings



## Language



## Data connections



## GSM network



National regulations may not permit roaming in your home region.

## Language setting

You can change the language used for display messages and/or text entry.

From **Language** menu

- 1 **Display language or Input language**  /
- 2 **required language**  /



## Data connections setting

GPRS settings and CSD settings are stored in the Data connections menu. Data can be sent/received using GPRS or CSD technology.

## Network setting

### Changing to a new network

The New Search function is used to manually select a network that is available in your current location.

From **GSM network** menu

- 1 **New Search**  /
- 2 **required network**  /



### Select Network

View available networks.

From **GSM network** menu

- 1 **Select Network**  /
- 2 **required network**
- 3 **required option (see page 23)**  /

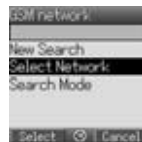

**NOTE** MCC (Mobile Country Code) / MNC (Mobile Network Code) will appear on the display.



# Settings



## GSM network



National regulations may not permit roaming in your home region.

When the Search Mode is set to Automatic the phone will automatically reselect a new network in order to maintain optimum network availability. The network list is used when the Search Mode is set to Automatic. The location numbers in the preferred network list show the search priority.

You can amend the list as follows:

Option	Explanation
Add	Store a new network at the end of the list
Insert	Store a new network in the currently displayed location and move other networks down
Edit	Overwrite the old network with a new one
Delete	Delete the network you have selected

### Search Mode

You can set your phone to automatically or manually search for the other networks when roaming.

From **GSM network** menu

- 1 **Search Mode**  /
- 2 **Automatic** or **Manual**  /

When the Search Mode is set to Manual the phone will only use a selected network.

If coverage is lost another network should be manually selected.



# Settings



## Calls



## Call settings

### Call Diverts

Voice, fax, and data calls can be diverted to different numbers in different situations. For example, you may want to divert voice calls to voice mail when the phone is switched off.

#### To register a number to divert at first time:

From **Calls** menu

- 1 **Call Diverts** /
- 2 **Divert Voice, Divert Fax or Divert Data** /
- 3 the circumstances to initiate the divert (Options)
- 4 **On** /
- 5 **Direct input or From Contacts** /
- 6 When you select **Direct input**, enter phone number to divert

(If you select after entering phone number, **Ok** / )

or

When you select **From Contacts**, required contact from the Contacts list

Request of Call Diverts will be sent to network.

Entered phone number will be registered in the network. From next time, incoming calls will be diverted to the registered number.

- To cancel the registered phone number, **Off** on step 4.
- To cancel all the registered phone number, **Cancel all** on step 2.
- To confirm the status of Call Diverts, **Status** on step 4.
- To confirm all the status of Call Diverts, **Status all** on step 2.

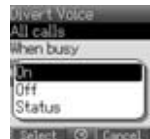

# Settings



## Calls



### To change the registered number to divert:

From **Calls** menu

- 1 **Call Diverts** /
- 2 **Divert Voice, Divert Fax or Divert Data** /
- 3 the circumstances to initiate the divert (Options)
- 4 **On** /
- 5 **Direct input or From Contacts** /
- 6 When you select **Direct input**, enter phone number to divert   
(If you select after entering phone number, **Ok** /   
or  
When you select **From Contacts**, required contact from the Contacts list

Request of Call Diverts will be sent to network.

**NOTE** When a divert situation is enabled the divert icon ( ) is displayed.

### Call Diverts settings

Settings	Explanation
All calls	Divert all incoming calls
When busy	Divert incoming calls when a call is in progress
When no reply	Divert incoming calls if call is not answered (This setting is available only when <b>Divert Voice</b> is selected.)
When unreachable	Divert incoming calls when phone is disconnected

This function is network dependent ( ).

### Call Waiting

If Call Waiting is switched on a second call can be received.

From **Calls** menu

- 1 **Call Waiting** /
- 2 The current status, "**Call Waiting deactivated**" or "**Call Waiting activated**" is displayed  
To accept the current status,   
(If you select , **Ok** /   
or  
To change the setting, **Activate** or **Deactivate** /

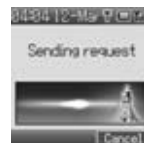

This function is network dependent ( ).

# Settings



## Calls



### Send my number

You can set whether or not to show your phone number to another phone (Caller ID).

From **Calls** menu

- 1 **Send my number**  /
- 2 **Network set, On or Off**  /



### Call Duration

Displays the duration of incoming or outgoing calls.

From **Calls** menu

- 1 **Call Duration**  /
  - 2 **Incoming or Outgoing**  /
- To reset counter,  x 2 / x 2



### Service Charge

You can check the charges for your calls.

From **Calls** menu

- 1 **Service Charge**  /

The following can be set.

- 1 required option  /

Option	Explanation
Cost Left	Show how much cost is left
Call Meter	Show the total costs of calls made
Price/Unit	Show the cost that the service provider charges for one unit of call time
Max Cost	Set the maximum cost of calls made

**NOTE** The duration of one unit may vary during day, peak and off-peak times. Call charges can be calculated accordingly. However, the call charge information may not give an accurate reflection of the actual tariffs charged by your service provider.

This function is SIM () and network () dependent.

# Settings



## Security



If PIN is entered incorrectly 3 times the phone will be locked, and you will need to enter the PUK code. If PIN2 is entered incorrectly 3 times SIM will be locked, and you will need to enter PUK2 code. If the PUK code is entered incorrectly 10 times, the phone will cease to operate permanently.

All information stored in the SIM will be lost and the SIM will need to be replaced. Contact your service provider for more information.

## Security settings

The PIN protects your SIM against unauthorised use. If you enable the PIN, every time the phone is switched on, you will be prompted to enter the PIN code. The PIN2 controls security for the Fixed Dial store.

### PIN entry (Enabling/Disabling PIN entry)

From **Security** menu

- 1 **PIN entry** /
- 2 **Enable/Disable** /
- 3 **Enable or Disable** /
- 4 Enter the PIN code (4 - 8 digits) /



### Change PIN

From **Security** menu

- 1 **PIN entry** /
- 2 **Change PIN** /
- 3 Enter the current code /
- 4 Enter the new code /
- 5 To verify the new code /

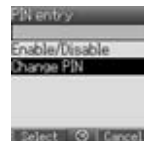

You can change the PIN when PIN entry is set to **Enable**.

### Change PIN2

From **Security** menu

- 1 **Change PIN2** /
- 2 Enter the current code /
- 3 Enter the new code /
- 4 To verify the new code /

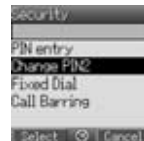

This is SIM (📱), service provider and network (🌐) dependent. (Please contact service provider to get more information for PIN2 code.)

# Settings



## Security



### Fixed Dial

Fixed Dial is a part of Contacts, but with added security.  
When Fixed Dial is enabled:

- Only numbers that are in the Fixed Dial store may be dialed.
- Any manually dialed phone numbers must match a number already in the Fixed Dial store.

If you store, edit or delete a phone number, you have to enter your PIN2 code.

From **Security** menu

- 1 **Fixed Dial**  /
- 2 **Enable or Disable**  /
- 3 Enter the PIN2 code (4 - 8 digits)  /



This is SIM () , service provider and network () dependent. (Please contact service provider to get more information for PIN2 code.)

### Call Barring

Call Barring restricts certain outgoing and/or incoming calls using a password supplied by your service provider. When updating/checking the status of Call Barring, the phone must be registered on a network.

Varying call restrictions can be used for voice calls.

From **Security** menu

- 1 **Call Barring**  /
- 2 required setting from the table shown below   
(When you select  , enter password (4 digits)  /
- 3 **On, Off or Status**  /
- 4 When you select **On** or **Off**, enter password (4 digits)  /



You can skip steps 3 and 4 if you enter your password in step 2.

### Call Barring settings

Settings	Explanation
Bar outgoing calls	Outgoing calls are barred
Bar foreign calls	International outgoing calls are barred
Bar foreign calls expect Home	International outgoing calls except home are barred
Bar incoming calls	Incoming calls are barred
Bar incoming if abroad	Roaming is barred if abroad
Cancel all	Cancel all call bar settings
Status all	Call bar status is displayed
Password	Change call bar password

# Settings



## Time and date



Time and date can be shown on the top of the display when in Idle mode.

## Any key answer



## Time and date setting

From **Time and date** menu

- 1 **Time** /
- 2 + to enter the time using 24 hour clock /
- 3 **Date** /
- 4 + to enter the date /

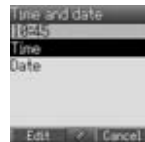

Some settings may be lost if the battery is removed or remains discharged for more than 1.5 hours.

## Any key answer setting

Calls can be answered by pressing any key except / / / .  
When any key answer is set to off, calls can only be answered by pressing or .

From **Any key answer** menu

- On or Off** /





# Settings



## Keyguard



## Keyguard setting

Keyguard stops the keys from performing their normal function if accidentally pressed. When Keyguard is enabled, “” appears on the display. When a call is received, Keyguard is temporarily disabled and you can answer the call.

### Setting Keyguard

From **Keyguard** menu

1 “Would you like to lock keypad?”  / 

or

From Idle display

1 Press and hold

2 “Would you like to lock keypad?”  / 

Emergency calls can still be made with the Keyguard enabled but there will be no indication that you are dialling a number.

### Disabling Keyguard

When “” appears on the display

1

2 “Would you like to unlock?”  / 

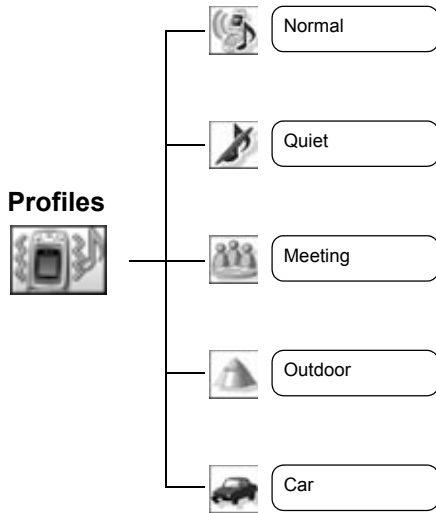

## Profiles



### Profile setting

You can switch between five profiles in your phone, each with a distinct combination of ring tone, ring volume, etc.

Profiles are set up for use in different environments – for instance you might want to create a Quiet profile, a Meeting profile with a ring tone appropriate for formal occasions and an Outdoor profile for noisy environments.

Within each profile, distinct melodies can be set as incoming call and message alerts.

#### Activating a profile

From **Profiles** menu

- 1 required profile
  - 2 **Activate** /
- or
- 1 required profile



#### Editing profile

##### Incoming Tone

From **Profiles** menu

- 1 required profile
- 2 **Edit** /
- 3 **Incoming Tone** /
- 4 **Preinstalled, My Media** or **Download** /
- 5 required data /



##### Incoming Volume

From **Profiles** menu

- 1 required profile
- 2 **Edit** /
- 3 **Incoming Volume** /
- 4 adjust the volume level (0 - 4) /



##### Message Tone

From **Profiles** menu

- 1 required profile
- 2 **Edit** /
- 3 **Message Tone** /
- 4 **Preinstalled, My Media** or **Download** /
- 5 required data /



# Profiles



## Message Volume

From **Profiles** menu

- 1 required profile
- 2 **Edit**  /
- 3 **Message Volume**  /
- 4 / adjust the volume level (0 - 4)  /



## Key Tone

From **Profiles** menu

- 1 required profile
- 2 **Edit**  /
- 3 **Key Tone**  /
- 4 required tone type  /



## Key Volume

From **Profiles** menu

- 1 required profile
- 2 **Edit**  /
- 3 **Key Volume**  /
- 4 / adjust the volume level (0 - 4)  /



## Warning Tone

From **Profiles** menu

- 1 required profile
- 2 **Edit**  /
- 3 **Warning Tone**  /
- 4 **On or Off**  /



## Vibration Alert

From **Profiles** menu

- 1 required profile
- 2 **Edit**  /
- 3 **Vibration Alert**  /
- 4 **On or Off**  /



# Text Entry (Edit)

You can use alphanumeric characters to enter details into Contacts, to create text, email messages, etc.

Key	Text mode		
	T9® (T9 ↑, T9 ↱ or T9) (Input language: English)	Multi-tap (Input mode indicator: Abc, ABC or abc)	Numeric (Input mode indicator: 0-9)
	Alternatives	. @ / - _ + 0	0/ (Hold)+
	., - ? ! " ' : ; / 1 * / (Hold) Character list	., ? ! " ' : ; @ / * ( ) # + _ = [ ] { } '   ` ~ ^ ~   < > £ ¢ £ \$ ¥ ¨ § Space ↵ / (Hold) Character list	1
	A B C 2 (a b c 2)	A B C 2 Γ Á Ä Å Æ Ç (a b c 2 α β γ á ä å æ à)	2
	D E F 3 (d e f 3)	D E F 3 Δ È (d e f 3 δ ε ζ é è)	3
	G H I 4 (g h i 4)	G H I 4 Θ Í (g h i 4 η θ ι i)	4
	J K L 5 (j k l 5)	J K L 5 Λ (j k l 5 κ λ μ)	5
	M N O 6 (m n o 6)	M N O 6 Ñ Ò Ó Ö Ø (m n o 6 ν ξ ó ô õ ø ò)	6
	P Q R S 7 (p q r s 7)	P Q R S 7 Π Σ (p q r s 7 π ρ σ ς β)	7
	T U V 8 (t u v 8)	T U V 8 Φ Ψ Ξ Ϊ (t u v 8 τ υ φ υ ΰ Ϋ)	8
	W X Y Z 9 (w x y z 9)	W X Y Z 9 Ψ Ω (w x y z 9 χ ψ ω)	9
	Shift / (Hold) Input mode	Shift / (Hold) Input mode	* / (Hold) Input mode
	Space / (Hold) Line feed	Space * # / (Hold) Line feed	# / (Hold) Line feed
	Delete text / (Hold) Delete all characters		

Displayed characters in the T9® mode vary depending on the selected input language.

## Shift mode

### Shift mode change

The Shift mode changes by pressing (within 1 sec) .

Multi-tap	Tegic
Abc -> ABC -> abc	T9 ↑ -> T9 ↱ -> T9

If Input mode is changed, Shift mode is initialised.

### Auto capital change

Auto capital affects Abc and T9 ↑.

If Input mode is changed to Abc or T9 ↑, the first character is input as upper case and subsequent letters as lower case. (Input mode indicator changes to abc or T9.)

If these characters [ . (Period) or ! or ? ] are input, the next character is input as upper case.

(Input mode indicator changes to Abc or T9 ↑.)

## Input mode

### Input mode change

Input mode changes by pressing and holding (over 1 sec) .

#### Input mode



Multi-tap -> Numerals -> T9 (Selected tegic language)

(Abc -> 0-9 -> T9 ↑)

The phone keeps the selected input mode.







## Text input

### T9®

Using this mode of text input dramatically reduces the number of key presses required: Press a key once for any letter you require on that key. The desired letter may not be displayed. Continue pressing other keys until the end of a word is reached, then check that the word has been typed correctly before continuing on to the next word. If the combination of letters typed has produced a word which is not the one you require, press ,  or  repeatedly until the correct word is displayed. Continue to the next word.





Example of text input in T9 mode

To type a new message, follow these steps:

- 1 At the beginning of a new message press and hold  (Clear) to delete previous text, if necessary.
- 2 Press  (Shift) to change letter case, if necessary.
- 3 Press    .

"Call" is displayed.

Note that the displayed words change as you type, always type to the end of the word before editing.

T9® languages can be selected from T9 Input, in options  →  **Input language**  / 

If the word you require is not in the internal dictionary, it should be entered using the Multi-tap (Abc) mode.

### T9 user's dictionary

Words that you entered are all saved in the user's dictionary so that they are suggested next time.

### Other text modes

Select text mode (displayed in top right corner on screen)

#### Multi-tap mode (Abc, ABC or abc):

Each time a key is pressed in quick succession, the next character available on that key is displayed. Releasing the key or pressing another key enters the character displayed. The cursor moves to the next position.

In T9 (T9 ↑) or Multi-tap (Abc) mode, the first entered letter in a sentence is in upper case.

# Messages Menu Structure

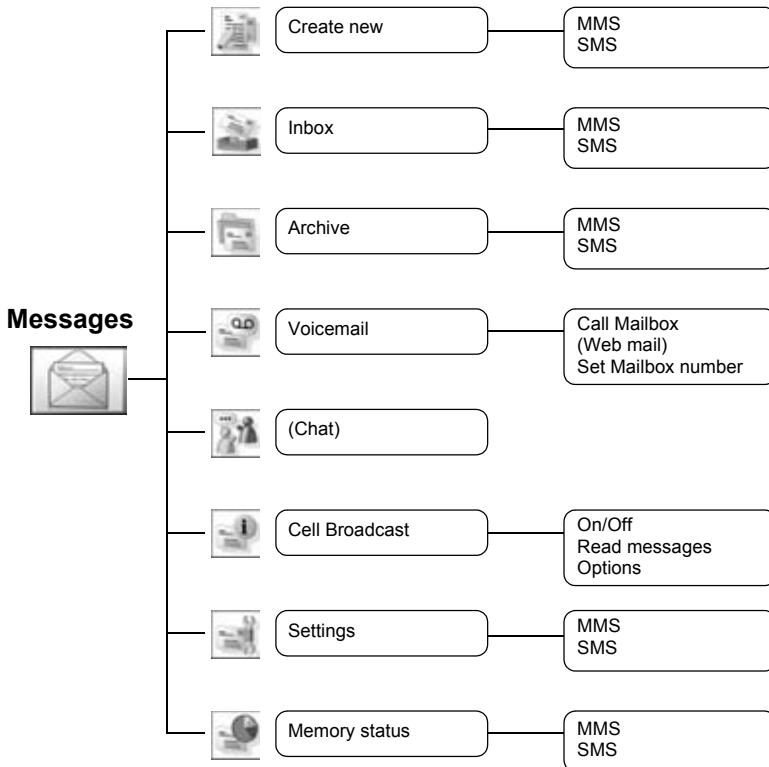

Chat and Web mail are network operator dependent ( ).

## Messages



### Create new



This phone has various messaging features including SMS and MMS.

## MMS (Multimedia Messaging Service)

Your phone is designed to be compatible with certain Multimedia Messaging Services (MMS). You can send picture and music with text messages. The recipient can play it as a slide show.

MMS messages can be sent to another mobile phone with MMS capability or to an email address.

When you receive an MMS message, a notice will inform you that you have received a message. (See page 40.)

An MMS profile may already have been set when you purchased your phone. To change the settings, see page 42. You can directly access Messages from Idle mode with the Left Soft key (⌂) or the Left key (⊙).

### Creating a new MMS

From **Create new** menu

1 **MMS** /

When creating a message, the following menu is available.

Menu item	Explanation
Add picture	Select a picture stored in <b>Stored pictures / Download</b> and insert it into the MMS message
Add text	Create text and add to MMS message
Add sound	Select sound stored in <b>Stored sounds / Download / Record new sound</b> and add to MMS message

2 After selecting a picture or sound or entering text, press for the following options

required option /

Option	Explanation
Edit text	Edit the text when selecting added text
Listen	Listen to the sound when selecting added sound
Send	Send MMS after entering the subject and recipient number or address
Remove picture/text/sound	Remove from the MMS
Preview slide	Preview MMS as a slide



# Messages



Create new



## Creating a slide

In order to send an MMS with more than one picture, text or sound, you need to add new slides to the MMS.

From **Create new** menu

- 1 **MMS**  /
- 2 **Add picture**, **Add text** or **Add sound**  / , then select a picture or sound, or enter a text
- 3 **Slides**

## Slide option

While Slides is highlighted, the following options are available by pressing .

required option  /

Option	Explanation
Add new	Add slide
Send	Send MMS after entering the subject and recipient number or address
Slide duration	Specifies duration of slide
Remove slide	Remove slide from the MMS
Preview slide	Preview MMS as a slide

# Messages



Create new



## Sending a message

When a message is completed, press

- 1 **Send** /
- 2 **Add subject**
- 3 Enter subject
- 4 **Add recipient**
- 5 **From Contacts, Enter number or Enter address** /
- 6 When you select **From Contacts**, required contact   
or  
When you select **Enter number**, enter number /   
or  
When you select **Enter address**, enter address
- 7 **Send**

Before sending a message, the following options are available by pressing .

required option /

Option	Explanation
Add subject / Add recipient	Add subject to MMS message / Add recipient to MMS message
Edit	Edit the subject or the recipient
Remove address	Remove address
Edit slide	Transit to "Slide" screen where you can edit slide
Send	Send MMS
Preview MMS	Preview MMS message
Save	Save MMS message to Drafts box
Create options	Set send options

## Creating options

Before sending a message, you can set send options.

When a message is completed, press

- 1 **Send** /
- 2 for the options
- 3 **Create options** /
- 4 required option /

Option	Explanation
Request read	Ask if the other party read the message
Request delivery	Check if your message has been delivered to the other party
Validity Period	Duration for which your message is stored at the message centre. Delivery attempts will be repeated until the message has been delivered or Validity Period expires.
Priority	Set the priority to normal, low or high
Delivery time	Specifies delivery time of a message to be sent

# Messages







Inbox







## Receiving messages

When you receive an MMS message, the message icon () is displayed along with a tone, illumination, and/or vibration.

From **Inbox** menu

- 1  **MMS**  / 
- 2  required notification 





The following options are available by pressing .

- 1  required option  / 



Option	Explanation
Receive	Receive new message
Reject	Delete message from the server and delete notification
Call	Call sender's number
Delete all	Delete all MMS messages in Inbox
Properties	Show message details (such as message size and date)

## Reading a received message

From **Inbox** menu

- 1  **MMS**  / 
- 2  required message 

When viewing the list, the following options are available by pressing .

- 1  required option  / 

Option	Explanation
Reply	Create reply message
Reply to all	Create reply message to the sender and all recipients of the message
Forward	Forward MMS message
Call	Call sender's number
Contact	Store sender's phone number or email address in Contacts
Delete	Delete MMS message
Delete all	Delete all MMS messages in Inbox
Properties	Display message properties

# Messages



## Archive



### Viewing message lists

The following messages are stored in Archive.

- **Outbox:** When a message has been sent it is stored in the Outbox.
- **Unsent:** Undelivered messages are stored in Unsent.
- **Drafts:** Use to create a message draft.

**MMS Drafts:** Messages that are saved in the MMS mode are saved in Drafts. If the transmission of an MMS message fails, the message is stored in Unsent together with other saved messages.

From **Archive** menu

- 1 **MMS** /
- 2 required list /

In each list, the following options are available by pressing .

- required option /

### Outbox

Option	Explanation
Edit	Edit MMS messages
Forward	Forward MMS messages
Delete	Delete MMS messages
Delete all	Delete all MMS messages in Outbox
Properties	Display message properties

### Unsent, Drafts

Option	Explanation
Edit	Edit MMS messages
Send	Send MMS messages
Delete	Delete MMS messages
Delete all	Delete all MMS messages in Unsent or Drafts
Properties	Display message properties

# Messages



## Settings



### Setting the MMS message server / profile

MMS message server and profile setting must be done before you can send or receive an MMS message. Please check with your network operator if additional settings are required. You can select one of five server URLs on the phone.

From **Settings** menu (Message server)

- 1 **MMS** /
- 2 **Advanced** /
- 3 **Message server** /
- 4 required message server
- 5 Enter URL if you need

From **Settings** menu (Profile)

- 1 **MMS** /
- 2 **Advanced** /
- 3 **Profile** /
- 4 select profile /

**NOTE** Before selecting MMS message server, you may have to set the profile if it is empty. To set server profile, see page 63, Browser - Options - Settings - WAP profiles.  
Modifying previously entered settings can cause failure of the server setting.

### Setting options

The following settings are available.

From **Settings** menu

- MMS** /

Option	Explanation
Reports	Set <b>Request read</b> (ask if the other party read the message) / <b>Send read</b> (inform the other party that you have read the message when asked) / <b>Request delivery</b> (ask if the other party received the message) / <b>Send delivery</b> (inform the other party that you have received the message when asked)
Priority	Set the priority to <b>Low</b> , <b>Normal</b> or <b>High</b>
Validity Period	Duration that your message is stored at the message centre. Delivery attempts will be repeated until the message has been delivered or Validity Period ( <b>1 day</b> , <b>7 days</b> or <b>Maximum</b> ) expires
Auto download	After receiving a message notification, the message will be sent to you automatically ( <b>Always on</b> ). Message set to be delivered automatically in home area ( <b>On when home</b> ). Message will be sent to you manually ( <b>Never</b> ). (This option is available only in Idle mode.)
Player mode	<b>Auto</b> mode enables MMS slides to be displayed according to their duration. <b>Manual</b> mode enables MMS slides to be displayed by pressing  /
Advanced	Set <b>Message server</b> , <b>Profile</b> , <b>Fetch on server</b> and <b>Anonymous reject</b> , and also view <b>Information</b> of MMS software

# Messages



Create new



## SMS (Short Message Service)

You can receive, display, edit and/or send text messages on any network that has a roaming agreement. (Dependent on the recipient's phone parameters.) The message centre number should be preprogrammed on the SIM, changing this number (see page 46) may cause failure of a text message.

### Creating a text message

From **Create new** menu

- 1 **SMS** /
- 2 Create text message – max. 459 characters, see “Text Entry” on page 34

When creating text, the following options are available by pressing .

- 1 required option /

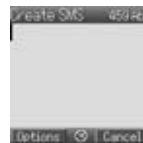

Option	Explanation
Send	Send text as SMS messages
Send to many	Send text to more than one recipient
Templates	Access to text templates in My Media
Save	Save message in Unsent
Copy	Copy text
Cut	Cut text
Paste	Paste text
Input language	Select input language
Exit	Return to Create new menu

### Sending a message

When you have created your message, press .

- 1 **Send** /
- 2 Enter the destination phone number

If you want to select from Contacts

- 1 **Send** /
- 2
- 3 required contact
- 4

Before sending a message, the following options are available by pressing .

- 1 required option /

Option	Explanation
Send	Send text as SMS messages
From Contacts	Select the destination phone number from Contacts
Save	Save message in Unsent
Exit	Return to “Create SMS” screen

# Messages



Inbox







## Receiving messages

When you receive an SMS message, the message icon (  ) is displayed along with a tone, illumination, and/or vibration.



## Reading a received message

From **Inbox** menu

- 1  **SMS**  / 
- 2  required message 



When viewing messages, the following options are available by pressing .

-  required option  / 

Option	Explanation
Reply	Create reply message to sender
Forward	Forward SMS message
Call	Call sender's number
Add to contacts	Store sender's number to Contacts
Use detail	Call or send messages to a phone number, email address or URL address in the message (This option is available only when viewing messages.)
Delete	Delete SMS message
Delete all	Delete all SMS messages (This option is available in the message list.)

By pressing , detail information of SMS will be shown.

# Messages



## Archive



### Viewing message lists

These message lists are stored in Archive.

- Outbox: When a message has been sent, it is stored in the Outbox.
- Unsent: If the transmission of an SMS message fails, the message is stored in Unsent together with other saved messages. Messages that are edited and saved in the SMS mode are saved in Unsent.
- Draft: Use to create a message draft.

[ SMS Draft: The last message you edit in the SMS mode is saved in the Draft. ]

From **Archive** menu

- 1 **SMS** /
- 2 **required list** /

In each list, the following options are available by pressing .

- required option** /

### Outbox, Unsent

Option	Explanation
Send	Send text as SMS messages
Call	Call receiver's number messages
Use detail	Call or send messages to a phone number, email address or URL address in the message (This option is available only when viewing messages.)
Delete	Delete SMS message
Delete all	Delete all SMS messages (This option is available in the message list.)

### Draft

Option	Explanation
Send	Send text as SMS messages
Send to many	Send text to more than one recipient
Templates	Access to text templates in My Media
Save	Save message in Unsent
Copy	Copy text
Cut	Cut text
Paste	Paste text
Input language	Select input language
Exit	Return to Archive menu



# Messages



↓  
**Settings**



## Setting the Message Centre number

The message centre number should be preprogrammed on the SIM, changing this number may cause failure of a text message.

From **Settings** menu

- 1 **SMS**  /
- 2 **Message Centre**  /
- 3 Enter message centre number in international dial format (see “International dialling” on page 10)

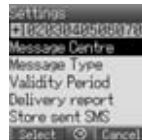

When the Message Centre number has been pre-installed, please do not change the number.

## Setting options

From **Settings** menu

- 1 **SMS**  /
- 2 required option  /

Option	Explanation
Message Centre	Edit Message Centre number
Message Type	Select required message type
Validity Period	Select maximum or choose a time limit for sent messages
Delivery report	Request a delivery report on the status of a sent message
Store sent SMS	Store messages to Sent SMS

# Messages



## Voicemail



## Voicemail

Voicemail is an innovative service that lets you stay up-to-date with all of your messages.

You must subscribe to voicemail through your service provider before you can retrieve voicemail or email messages.

### **Listening to Voicemail messages**

From **Voicemail** menu

**Call Mailbox** /

Stored mailbox number is dialed and you can listen to voice messages.

### **Connecting to internet mail**

From **Voicemail** menu

**Web mail** /

Your phone is connected to the Internet via a WAP connection to retrieve email messages.

This function is network operator dependent ( / ).

### **Setting the Mailbox number**

From **Voicemail** menu

1 **Set Mailbox number** /

2 Enter the mailbox number (when necessary) / x 2

## Chat

Chat lets you enjoy the fun of instant messaging wherever you are. It's the fun way to chat on-line.

➤ More information on this service may be obtained from your service provider.

## Chat



### **Viewing Chat**

From **Chat** menu

Follow the screen contents

This function is network operator dependent ( / ).

It allows you to read sent and received messages with another party on one screen.

# Messages



## Cell Broadcast



## Cell Broadcast

You can receive messages on specified topics, such as traffic and weather information, from your network operator.

### Setting Cell Broadcast On/Off

From **Cell Broadcast** menu

- 1 On/Off  /
- 2 On or Off  /

### Reading a received message

From **Cell Broadcast** menu

- 1 Read messages  /
- 2 required message

This function is your network operator dependent ().

### Options

You can add, edit and delete topics and languages.

From **Cell Broadcast** menu

- 1 Options  /
- 2 Topic or Language  /
- 3 required topic or language
- 4 Add, Edit or Delete  /

## Memory status

You can see MMS/SMS memory status.

### Viewing MMS/SMS memory status

From **Memory status** menu

- 1 MMS or SMS  /

The current percentage of MMS saved in Phone are displayed.

or

The current percentage of SMS saved in SIM and in Phone are displayed.

## Memory status



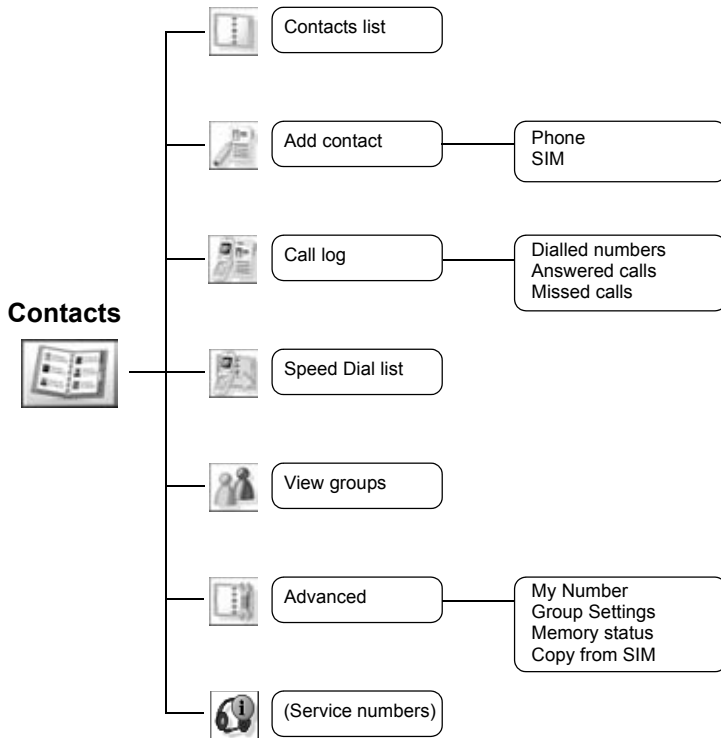

Service numbers is SIM dependent (☐).

## Contacts



### Contacts list



## Browsing Contacts

You can search Contacts by name.

When browsing by name, pressing a letter key will take you to the first entry starting with that letter.

From **Contacts list** menu

1 required contact



### Options in Contacts

From **Contacts list** menu

1 required contact

2 required option

Option	Explanation
Call	Call contact
Send message	Send MMS/SMS to the selected contact from Contacts list
Edit	Edit contact
Add contact	Add contact to Contacts list
Copy to SIM/Phone	Copy contact to SIM or Phone
Speed dial	Add to Speed Dial list
Delete	Delete contact
Search	Search contact by entering characters (max. 18 characters)
Send by Infrared	Send contact to another device by Infrared

# Contacts



Phone numbers can be stored in your SIM or in your phone.



## Add contact



## Storing

### Storing a number in SIM

In the SIM, you can store: name, phone number.

The length of name and number and the total amount of data are dependent on your SIM.

From **Add contact** menu

- 1 **SIM** /
- 2 name icon
- 3 Enter the name
- 4 mobile icon
- 5 Enter the phone number /
- 6



### Options in SIM Contacts

When the name is being entered, the following options are available by pressing .

- required option /

Option	Explanation
Copy	Copy letters into buffer
Cut	Cut and store letters into buffer
Paste	Paste letters from buffer
Input language	Select input language
Exit	Return to Add contact

# Contacts



Add  
contact



## Storing a number in your phone

In the phone, you can store: name, phone no. 1, phone no. 2, email address, picture and group.

From **Add contact** menu

- 1 **Phone**  /
- 2 name icon ( )
- 3 Enter the name
- 4 mobile icon ( )
- 5 Enter the phone number  /
- 6 telephone icon ( )
- 7 Enter the phone number  /
- 8 email icon ( )
- 9 Enter email address
- 10 picture icon ( )
- 11 required picture from My Media ( ) or preinstalled pictures  /
- 12 group icon ( )
- 13 required group  /
- 14



**NOTE** If a picture image for a contact is selected from My Media, the image will appear on the screen when the contact calls you. Preinstalled pictures are not applicable in this function.

## Options in Phone Contacts

When the name and email address are being entered, the same options as SIM Contacts are available by pressing . (See page 51.)

# Contacts



## Call log



## Call log

Recently dialed phone numbers, answered calls and missed calls are stored in the Call log. The numbers in the Call log list can be used to call, send messages or add to Contacts. You can also delete the numbers from the list.

### Viewing Call log

From **Call log** menu

- 1 **Dialled numbers, Answered calls or Missed calls**
- 2 required phone number

### Dialling from Call log

From **Call log** menu

- 1 **Dialled numbers, Answered calls or Missed calls**
- 2 required phone number
- 3 / to call

### Sending messages

From **Call log** menu

- 1 **Dialled numbers, Answered calls or Missed calls**
- 2 required phone number
- 3
- 4 **Send message** /
- 5 **MMS or SMS** /
- 6 Enter a message

For details on creating a message, see “Creating a new MMS” on page 37 or “Creating a text message” on page 43.

### Saving a phone number from Call log into the Contacts list

From **Call log** menu

- 1 **Dialled numbers, Answered calls or Missed calls**
  - 2 required phone number
  - 3
  - 4 **Add to contacts** /
  - 5 **Phone or SIM** /
  - 6 required icon
  - 7 Enter as appropriate
- (If required, repeat steps 6 and 7)
- 8



# Contacts



## Call log



### Options in Call log

In each Call log list, the following options are available by pressing . required option /

Option	Explanation
Call	Call selected number
Send message	Send MMS/SMS message to selected number
Add to contacts	Store number to Contacts
Delete	Delete selected log
Delete all	Delete all logs in the list (This option is available in the Call log list.)

### Speed dial

Phone numbers from the Speed dial of Contacts can be dialled quickly. In Idle mode, press and hold a number key (2 - 9).

## Speed Dial list



### Setting Speed dial

From **Speed Dial list** menu

- required list
- Enter phone number /

You can also select a phone number from Contacts by pressing in step 1.



### Viewing stored numbers

In Idle mode, press and hold a number key (2 - 9).

### Making a call by using Speed dial

From Idle display

- Press and hold a number key (2 - 9)
- required list /

# Contacts



## View groups



## Grouping Contacts entries

The ability to group Contacts entries together is an extra function of Phone Contacts. Groups are used to collect together types of Contacts entries, e.g. business and personal. Each group can be suitably titled for quick access to the entries contained within.

You can attach a particular sound to the groups to identify them. (See "Group settings" on page 57.)

### Viewing groups

From **View groups** menu

required group  /

The following options are available by pressing .

required option  /

Option	Explanation
Call	Call contact
Send message	Send MMS/SMS to the selected contact
Edit	Edit contact
Add contact	Create contact in Phone Contacts or SIM Contacts
Copy to SIM	Copy contact to SIM
Speed dial	Add to Speed Dial list
Delete	Delete contact
Search	Search contact by entering characters (max. 18 characters)
Send by Infrared	Send contact to another device by Infrared

# Contacts



## Advanced



## My Number

My Number is a contact where you can store your own numbers.

### Adding numbers

From **Advanced** menu

- 1 **My Number** /
- 2 **Mobile Profile** or **SIM Profile** /
- 3 When My Number is empty, press / then go to step 5  
When My Number is already stored in SIM Profile, press
- 4 **Create** /
- 5 name icon ()
- 6 Enter the name
- 7 mobile icon ()
- 8 Enter the phone number /
- 9

**NOTE** If you select **Mobile Profile**, you can also select information such as additional number, email address and picture.

### Viewing stored numbers

From **Advanced** menu

- 1 **My Number** /
- 2 **Mobile Profile** or **SIM Profile** /

### Options in My Number

When viewing My Number, the following options are available by pressing .

- required option /

#### Mobile Profile (View Display)

Option	Explanation
Edit	Transit to Edit profile
Delete	Delete profile
Send by Infrared	Send profile by Infrared

#### SIM Profile (View Display and List Display)

Option	Explanation
Edit	Transit to Edit profile
Create	Transit to Create profile
Delete	Delete profile
Send by Infrared	Send profile by Infrared

# Contacts



## Advanced



## Group settings

You can change the group name and attach a sound to the group.

### Changing group names

From **Advanced** menu

- 1 **Group Settings** /
- 2 required group
- 3 Press and hold to clear the current name
- 4 Enter new group name

### Attaching a sound to a group

From **Advanced** menu

- 1 **Group Settings** /
- 2 required group
- 3 **Sound Type** /
- 4 **Preinstalled, My Media or Download** /
- 5 required sound type /

Selecting **<Default>** in step 4, you can also select a default sound.

### Memory status

Memory status shows how many locations are available in the Contacts.

From **Advanced** menu

- Memory status** /

### Copy from SIM

You can copy SIM Contacts to Phone Contacts.

From **Advanced** menu

- Copy from SIM** x 2 / x 2

## Service numbers



### Service numbers

When SIM containing SDN (Service Dialling Number) is inserted in your phone, you can call a service number by selecting from the list.

SDN enables you to access special services provided by your network operator, such as customer support, emergency services, etc.

## Browser



PANASONIC BOX

# Browser



The phone's WAP (Wireless Application Protocol) Browser enables you to access Internet services supported by the network, such as news, weather reports, sport etc.

## Server setting

Before Internet services can be accessed, you need to subscribe to your network operator or Internet Service Provider (ISP) to enable the relevant configuration information. Please contact your network service provider to ensure that your network settings are correct.

Modifying previously entered settings may cause failure of the browser.

From **Browser** menu

- 1 (Options)
- 2 **Settings** /
- 3 **WAP profiles** /



Ten server settings can be set up in the phone. If you find your server's name under WAP profiles, select the server and press (Options) then select **Edit** and press . If no settings are present contact your network service provider for these settings. [Profile name, Home page, Gateway, Port, Data connections (GPRS and CSD setting)]

You need to set GPRS and CSD setting in Settings > Data connections menu before setting the server information.

Those configuration Options will be given by network service provider. Once completing the entry, press (Save) then press or select **Activate** after (Options) is pressed.

The first time that the browser is activated there will be no content stored so the Home URL content will be displayed (as defined by the network operator). The Home URL will be recalled from the cache, each time the browser is activated. (Cache is the phone's memory that stores content downloaded in the past.)

## Viewing the contents

From **Browser** menu

Select menu

In each list, options are available by pressing . (See page 60.)

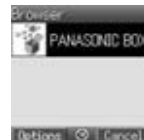

# Browser



## Browser options

From **Browser** menu

- 1 (Options)
- 2 select from below options /

Option	Explanation
Select	Select item
Bookmarks	Go to bookmark list
Enter address	Go to URL entry
Save image	The image in contents is saved in "My Media"
Set as bookmark	The displayed URL will be saved in Bookmarks
Service Inbox	Open Service Inbox
Reload page	Reload this page
Advanced	Go to homepage, clear the cache, view URL or view WAP information
Settings	Edit profiles/Push access or view security information
Exit browser	Terminate the browser

Go to page  
Add bookmark  
Edit  
Delete

Home  
Clear cache  
View address  
WAP information

WAP profiles  
Push access  
Security

## Browser options (Bookmarks)

From **Browser** menu or contents

- 1 (Options)
  - 2 **Bookmarks** /
  - 3 required bookmarks
  - 4 to load the URL
- or
- to select options

From **Browser** menu

From contents

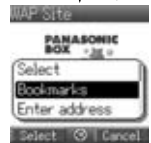
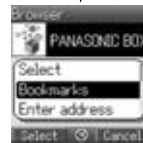
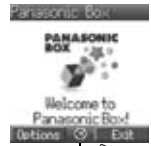

### Options:

Go to page ..... Jump to the URL page  
 Add bookmark ..... Add to bookmarks  
 Edit ..... Edit bookmark  
 Delete ..... Delete bookmark

# Browser



## Browser options (Enter address)

You can jump to the required content by entering the URL.

From **Browser** menu or contents

- 1 (Options)
- 2 **Enter address** /
- 3 Enter URL

## Browser options (Save image)

Displayed images can be saved in "My Media".

From contents

- 1 (Options)
- 2 **Save image** /
- 3 to see whole image
- 4 / to save

## Browser options (Set as bookmark)

Favourite URLs can be saved in bookmarks.

From contents

- 1 (Options)
- 2 **Set as bookmark** /
- 3 Enter title to save

## Browser options (Service Inbox)

View WAP push message and go to URL.

From contents

- 1 (Options)
  - 2 **Service Inbox** /
  - 3 to load the URL
- or
- to select options



**Options:**  
 When text and URL are delivered from your service provider, the following options are available.  
 Go to page ..... Jump to the URL page  
 View message..... View message  
 Delete..... Delete message

When only URL is delivered from your service provider, the following options are available.  
 Go to page ..... Jump to the URL page  
 Delete..... Delete message



# Browser



## Browser options (Reload page)

Current page can be reloaded.

From contents

- 1 (Options)
- 2 **Reload page** / to reload this page



## Browser options (Advanced)

From **Browser** menu or contents

- 1 (Options)
- 2 **Advanced** /

### **Browser options (Advanced - Home)**

Phone jumps to the set-up homepage.

From **Advanced** menu

- 1 **Home**
- 2 / to jump to homepage

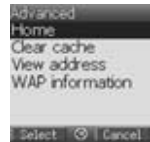

### **Browser options (Advanced - Clear cache)**

Cache is cleared.

From **Advanced** menu

- 1 **Clear cache** /
- 2 / to clear the cache



### **Browser options (Advanced - View address)**

View URL of the contents.

From **Advanced** menu

- 1 **View address** /



### **Browser options (Advanced - WAP information)**

View WAP information.

From **Advanced** menu

- 1 **WAP information** /



**NOTE** **View address** is available only from contents.

# Browser



## Browser options (Settings)

From **Browser** menu or contents

- 1 (Options)
- 2 **Settings** /

### **Browser options (Settings - WAP profiles)**

Set up WAP browser.

From **Settings** menu

- 1 **WAP profiles** /
  - 2 required profile
  - 3 to activate
- or
- to select options

### **Browser options (Settings - Push access)**

Set up Push access to receive WAP messages.

From **Settings** menu

- 1 **Push access** /
- 2 **Service Indication, Service Loading** or **Other messages** /
- 3 **On or Off** /

### **Browser options (Settings - Security)**

View security information.

From **Settings** menu

- 1 **Security** /
- 2 **Certificates, Current certificate** or **Session info** /

# Games Menu Structure

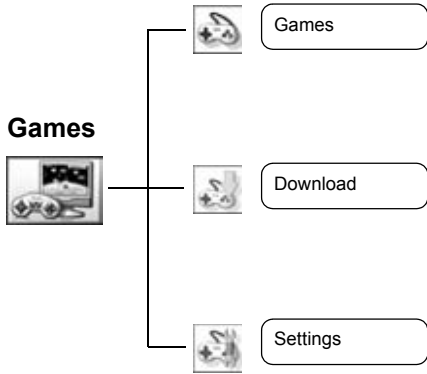

## Games



### Games



## Selecting games

You have one pre-installed Java™ application – Ninja Action. The downloaded Java™ applications may also be listed.

From **Games** menu

Java™ application you want to play

The following options are available by pressing .

required option /

Option	Explanation
Properties	Indicate application name, version, vendor, description and store size
Update	Update Java™ application
Delete	Delete Java™ application

Your phone supports J2ME™ Java™ applications. Other types of Java™ applications cannot be installed.

### Ninja Action

This game is an action puzzle game. The purpose of this game is to turn over the randomly arranged tatami mats so that they are all face up (green) within a specified time limit.

#### Key operation:

or , , and to move the character.

or to turn over four tatami mats above/below or on the left/right of the character.

### Download



## Downloading games

The downloaded Java™ applications will be stored in Games menu.

From **Download** menu

Select required Java™ application

# Games



## Settings



## Settings

Java™ applications settings, such as volume and backlight etc, can be changed.

Settings	Explanation
Sound volume	Volume setting for Java™ applications
Backlight	ON/OFF setting of Backlight in Java™ applications
Vibration	ON/OFF setting of Vibration in Java™ applications
Online service	Settings for online Java™ application connections
Memory status	Display of Memory status
Reset	Deletion of downloaded Java™ file and reset records of preinstalled Java™ application
Information	Display of copyright information

**If “Online service” is selected more options are displayed as follows.**

Ask ..... When a Java™ application with HTTP access is activated the phone must ask user’s permission to access network.

Yes ..... Always allow online connections.

No ..... Never allow online connections.

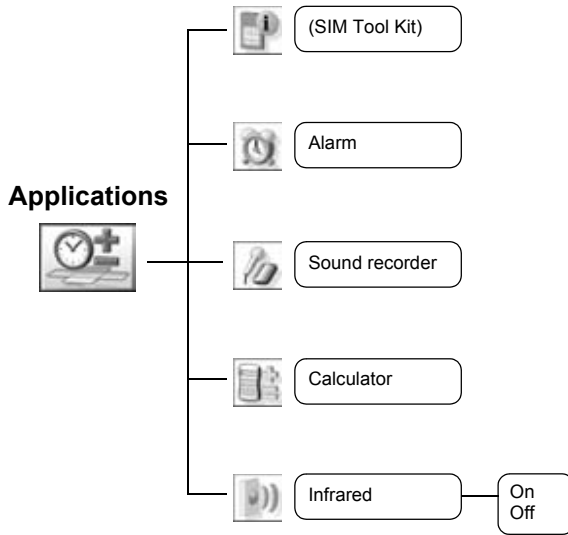

SIM Tool Kit is SIM dependent (). The menu name will be changed.

## Applications



### SIM Tool Kit



### Alarm



When the set time is reached, the alarm will sound and the display will light with an alarm message.



































## STK (SIM Tool Kit)

This function is SIM dependent () . This menu name will be changed.

### Alarm

#### Setting the alarm

From **Alarm** menu

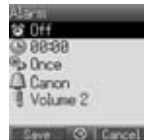

- 1  alarm icon ()  ,  **On**  / 
- 2  clock icon ()  , enter the required time (24 hour clock)  / 
- 3  alarm repetition icon ()  ,  **Once, Everyday, Weekdays or Weekend**  / 
- 4  sound set-up icon ()  ,  **Preinstalled, My Media or Download**  /  ,  required ring type  /  (When you select **My Media**,  to select required ring type.)
- 5  volume icon ()  ,  adjust the volume  / 
- 6  to save the settings



When the alarm has been set, an alarm icon () will be displayed when the phone is in Idle mode.  
The alarm is activated based on the current clock.







#### Muting the alarm

**To stop the alarm:**

- 1 Press any key or 
- 2  / 







**To disable the alarm:**

From **Alarm** menu

- 1  alarm icon () 
- 2  **Off**  / 
- 3  to save the setting

#### Adjusting the alarm time

From **Alarm** menu

- 1  clock icon () 
- 2 Enter the required time  / 
- 3  to save the setting

If you want to change other settings, see "Setting the alarm".

# Applications

## Snooze Function



Snooze Function lets the alarm repeat 5 times if you do not press / after stopping the alarm or press to stop the alarm.

### To stop Snooze Function:

Press / when "Stop snooze?" appears in the display.

If you press / , the alarm will repeat 5 more times at 5 minutes intervals until "End of alarm" is displayed.

**NOTE** The alarm goes off at the time you set even if the phone is off.

## Alarm



## Sound recorder



## Sound recorder

You can record sounds or your voice in My Media. The recorded sound files you record can be attached to MMS messages.

### Recording new sound

From **Sound recorder** menu

- 1 / to start recording
- 2 / to stop recording (The max. recording time is 15 seconds)
- 3
- 4 **Save** /

If you select **Send MMS**, you can access the MMS menu.



### To play a sound:

after step 2

To adjust the volume,

To stop playback, / /

**NOTE** When you finish recording and finding that My Media is full, the recorded sound can be saved if you make space by deleting files (pictures, sounds and text templates). Press to delete unwanted files.

## Calculator



## Calculator

You can use the 4-function calculator (addition, subtraction, multiplication and division) to make simple arithmetic operations.

From **Calculator** menu

- 1 Enter a number (max. 10 digits) and it will be displayed  
If a decimal point is required, press
- 2 To select arithmetic operation  
( to multiply, to add, to divide, to subtract)
- 3 Enter a number (max. 10 digits) and it will be displayed
- 4 to calculate





# Applications Infrared



## Infrared



If you try to send data that cannot be forwarded or saved, an error message will be displayed.

By using the Infrared connection with another A500 or with other devices with an infrared port, you can transfer data between the devices.

### Preparing for Infrared connection

- Place the A500 and another device with an Infrared port within the effective Infrared connection range of each other.
- There must be no obstruction between the two communicating devices.
- The Infrared ports of both devices must point at each other.
- If you use a PC, you need to set up an Infrared connection on the PC.  
(Example: **Start > Settings > Control Panel > Infrared > Options tab > Enable Infrared Communication**)

### Sending data

The types of data you can send are: Contacts, Pictures and Sounds in My Media. Ensure that the Infrared ports of your A500 and the second phone or device are pointing at each other with no obstructions in between.

Some downloaded files may be protected under copyright laws. These files should not be sent.

### Setting Infrared

You need to activate Infrared before receiving data.

From **Infrared** menu

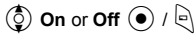

**NOTE** When Infrared is set to on, “

### Sending pictures and sounds

From Idle display

- 1
- 2 **My Media** /
- 3 **Pictures or Sounds** /
- 4 required item /
- 5 select data to send
- 6 **Send by Infrared** /



# Applications















## *Sending Contacts*



## Infrared



From Idle display



- 1  / 
- 2  **Contacts**  / 
- 3  **Contacts list**  / 
- 4  select contact to send  / 
- 5  **Send by Infrared**  / 



## *Receiving data via Infrared port*

You need to activate Infrared before receiving data.

**Data received** message is displayed then sent data is displayed.

-  /  to save the data  
or  
 to cancel

## Calendar







### Viewing calendar

From **Calendar** menu

 will display recent and future calendars



The following options are available by pressing .

 required option  

Option	Explanation
Go to date	Jump to the required date
Week starts on	Select which day the week starts on

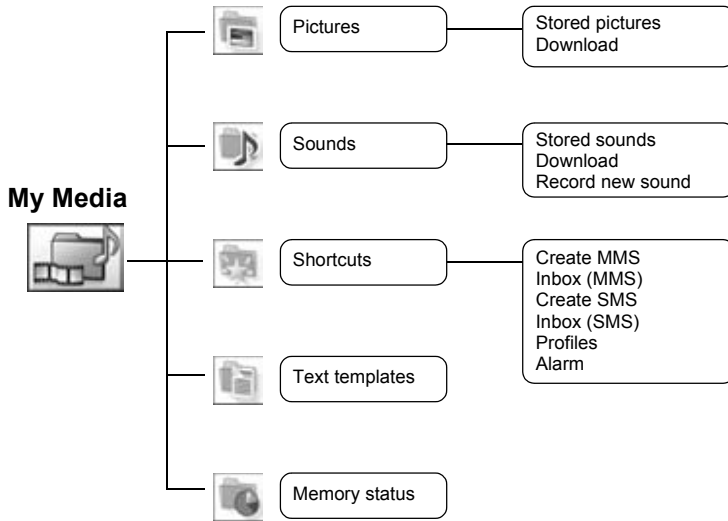

## My Media



The data saved in the A500 is located in My Media. There are four pre-defined folders (Pictures, Sounds, Shortcuts, Text templates). The maximum capacity of the Data Folders is approx. 1 MB.



## Pictures



## Pictures (My Media > Pictures)

You can manage pictures downloaded from the internet etc.

### Viewing pictures

From **Pictures** menu

- 1 **Stored pictures** /
- 2 required picture

### Downloading picture

From **Pictures** menu

- 1 **Download** /
- 2 The picture download site will be displayed

### Picture options

When a picture is selected, the following options are available by pressing .

- 1 required option /

Option	Explanation
Send MMS	Attach pictures to MMS messages (see "MMS")
Send by Infrared	Send pictures to another device by Infrared
As wallpaper	Use pictures as Wallpaper
Add to contacts	Add pictures to contact
Rename	Rename picture files
Delete	Delete picture files
Properties	Show file name, size, date and forward lock status

# My Media



## Sounds



## Sounds (My Media > Sounds)

Downloaded sounds and Recorded sounds are stored in Stored sounds.

### Checking sounds

From **Sounds** menu

- 1 **Stored sounds**  /
- 2 **required sound**

### Downloading sounds

From **Sounds** menu

- 1 **Download**  /
- 2 The sound file download site is displayed

### Recording new sound

From **Sounds** menu

- 1 **Record new sound**  /
- 2 The phone switches to Sound recorder mode (see page 69)

### Options in sound file (Stored sounds)

When a sound is selected, the following options are available by pressing .

- required option  /



Option	Explanation
Send MMS	Attach sound files to MMS messages (see "MMS")
Send by Infrared	Send sound files to another device by Infrared
Set alert tone	Set sound files to Incoming tone, Message tone and Group tone (AMR files cannot be set to alert tones.)
Rename	Rename sound files
Delete	Delete sound files
Properties	Show file name, size, date and forward lock status

# My Media



## Shortcuts



## Shortcuts

You can create shortcuts you want to use in My Media.

### Viewing shortcuts

From **Shortcuts** menu

required content

The following options are available by pressing .

required option /

Option	Explanation
Edit	Overwrite the present shortcut with a new one
Move	Move shortcut to another place in the list
Add	Store new shortcut
Delete	Delete shortcut

#### Access to shortcuts:

From Idle display

- 1
- 2 required shortcut

## Text templates

You can use templates stored in the phone when creating a text message. You can also save frequently used text as templates.

## Text templates



### Editing the Text templates

From **Text templates** menu

required template

(The display will turn to editing display)

The following options are available by pressing .

required option /

Option	Explanation
New	Add words to new template
Send message	Send template to MMS or SMS
Edit	Edit template
Delete	Delete template
Properties	Show size and date

## My Media



## Memory status



## Memory status

You can see how much data is stored in the individual folders in My Media.

The memory in "My Media" is separate from the MMS storage and Java™ storage.



# Personal WAP/MMS Settings

Use the table below to record your GSM/GPRS WAP/MMS settings.

Item	Provisioning information setting				
	No.1	No.2	No.3	No.4	No.5
Profile name					
Homepage					
Gateway					
Port (Non secure / Secure)					
Data connections					
<b>CSD</b>					
Profile name					
Account					
Password					
Call type					
Phone number					
Idle timer					
<b>GPRS</b>					
Profile name					
Account					
Password					
APN name					
Auth type Normal / Secured / None (PAP) (CHAP)					
Message server					

Item	Provisioning information setting				
	No.6	No.7	No.8	No.9	No.10
Profile name					
Homepage					
Gateway					
Port (Non secure / Secure)					
Data connections					
<b>CSD</b>					
Profile name					
Account					
Password					
Call type					
Phone number					
Idle timer					
<b>GPRS</b>					
Profile name					
Account					
Password					
APN name					
Auth type Normal / Secured / None (PAP) (CHAP)					
Message server					

# Troubleshooting

Should any problem persist, contact your dealer.

Problem	Cause	Remedy
Phone will not switch on.	_____	Check that the battery is fully charged and correctly connected to the phone.
Extremely short battery life for a new battery.	The network you are using and the condition of the battery can affect battery life.	_____
Short battery life for an old battery.	The battery has worn out.	Replace with a new fully charged battery.
The charging indicator does not light, the battery level indicator does not appear and the phone cannot be switched on when charging.	The battery is not attached to the phone or, when the battery has been deeply discharged, the phone will take a short time until the indicator lights.	Leave the phone charging the battery for a few minutes before the indicator lights and you attempt to switch the phone on.
Battery fails to charge.	The battery is not attached to the phone.	Ensure the battery is fitted to the phone prior to commencing charging.
	Battery was attached to the phone after the Fast Travel Charger was connected.	
Calls cannot be made.	Keyguard is on.	Disable Keyguard.
	Outgoing calls are barred.	Disable outgoing Call Barring or barred dialling.
	The phone is not registered on a network.	Move to a coverage area and operate your phone after it has registered with a network.
Calls cannot be made from Fixed Dial store.	_____	Check whether your SIM supports Fixed Dial. Check if Fixed Dial is switched on. Check whether the phone number is stored in Fixed Dial.
Calls cannot be received.	The phone is not switched on.	Switch the phone on.
	Incoming calls are barred.	Disable incoming Call Barring.
	The phone is not registered on a network.	Move to a coverage area and operate your phone after it has registered with a network.
Emergency calls cannot be made.	You are not in a GSM coverage area.	Check that the antenna symbol (  ) is displayed – move to a coverage area and operate your phone when the antenna symbol is displayed.

## Important error messages

These are some of the most important error messages which may be displayed:

Failed	Roaming in the selected area is not allowed.
	Roaming with the selected network is not allowed.
	The network has detected an authentication failure because your SIM is not registered with that network – contact your service provider.
SIM blocked	The SIM is blocked because the PIN unblocking key (PUK) has been entered incorrectly ten times – contact your service provider.
Insert SIM	The phone has detected a problem with the SIM – switch the phone off and then back on; if the message is still displayed contact your service provider.
Invalid SIM	The SIM has failed one or more of the SIM personalisation checks – contact your service provider.
Function unavailable	The selected feature is either not supported by the SIM or is not available with the current subscription – contact your service provider.
PIN2 invalidated	The PIN2 is blocked permanently because the wrong PUK2 has been entered ten times, services controlled by PIN2 cannot be used – contact your service provider.
Message rejected. Storage full or Message rejected. SIM full	A message has been received but the message store is full – to receive messages, delete some of the currently stored messages.
Too many characters.	The edited or newly created contact number is too long for the SIM.
This message may not be stored	The message area is full. Your messages cannot be stored until some of the currently stored messages are deleted.
Verification failure	On changing the PIN/PIN2, verification of the new code is incorrect – retry changing the PIN/PIN2 with correct verification.
Auto redial list full	Redial list of unsuccessfully dialled numbers is full – switch the phone off and then on again.

# Glossary of Terms

APN	Access Point Name. Directs the user to the gateway or the required service.
CHAP	Challenge Handshake Authentication Protocol. A security feature in the GPRS network.
Copy	Copies selected text from a short text message without removing it from the original message.
CSD	Circuit Switched Data. A communication method used to transmit data over telephone connections.
Cut	Permanently removes selected text from a short text message.
DTMF Tones	Dual Tone Multi-Frequency tones allow you to communicate with computerised phone systems, voice mailboxes, etc.
GPRS	General Packet Radio Service. A GSM transmission technique that transmits and receives data in packets rather than setting up a continuous channel. It makes very efficient use of available radio spectrum and users pay only for volume of data sent and received.
GSM	Global System for Mobile communications. The name given to the advanced digital technology that your phone uses.
MMS	Multimedia Messaging Service. An advanced mail system used for cellular phones. This service allows sending/receiving text messages and attaching pictures, animation and sound to the same.
Network Operator	The organisation responsible for operating a GSM network.
PAP	Password Authentication Protocol. A security feature in the GPRS network.
Password	Used for the control of GPRS/CSD settings in Data connections and the control of Call Barring. Supplied by your service provider.
PIN	Personal Identification Number used for SIM security. Supplied by your service provider. If the PIN is entered incorrectly 3 times, the PIN will be blocked.
PIN2	Personal Identification Number used for the control of Fixed Dial store and Call Charge metering. Supplied by your service provider. If the PIN2 is entered incorrectly 3 times, the PIN2 will be blocked.
PUK/PUK2	PIN/PIN2 Unblocking Key. Used to unblock the PIN/PIN2 code. Supplied by your service provider. If the PUK/PUK2 is entered incorrectly 10 times, the PUK/PUK2 will be blocked.
Registration	The act of logging on to a GSM network. This is usually performed automatically by your phone.
Roaming	The ability to use your phone on networks other than your home network.
Service Provider	The organisation responsible for providing access to the GSM network.
SIM	Subscriber Identity Module. A small smart-card which stores unique subscriber and user-entered information such as Contacts entries and short messages. Supplied by your service provider.
SMS	Short Message Service. A basic mail system used for cellular phones. This service allows sending/receiving of short text messages.
URL	Uniform Resource Locator. The URL is an alphanumeric address that points to homepages and other Internet locations.
WAP	Wireless Application Protocol. The communication standard which enables you to download resources from the Internet to your phone.

# How to Change the X Changeable Cover

Before changing the cover, always switch off the power and disconnect the phone from the charger or any other device. For your safety, follow these procedures when removing or attaching the cover.

## **Removing the cover**

Loosen and remove the 4 screws with the screw driver included in this package and then gently remove the cover.

## **Attaching the cover**

Place the cover right in the hollow in the phone and tighten the 4 screws firmly. Ensure that there is no dust caught between the cover and the hollow.

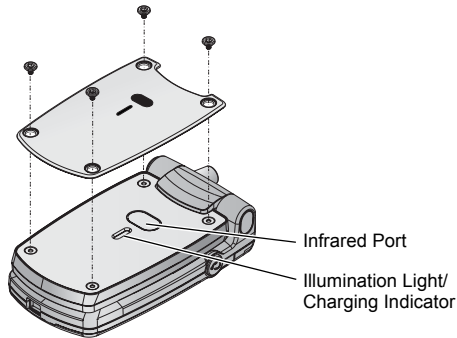

Always carry or store the phone with the cover attached.

Do not touch the Infrared Port or Illumination Light/Charging Indicator underneath the cover.

Do not overtighten the screws or force to screw when the cover is not placed in the right position. Do not force to pull the cover.

Use only covers designed for this model.

## A

Add contact .....	51
Advanced .....	56
Alarm .....	68
Alert mute .....	4
Any key answer .....	10, 29
Applications .....	68
Archive	
MMS .....	41
SMS .....	45

## B

Backlight time .....	21
Battery	
Attaching .....	1
Battery level indicator .....	2
Charging .....	2
Low battery power warning .....	2
Removing .....	1
Brightness .....	21
Browser .....	59
Browser options	
Advanced - Clear cache .....	62
Advanced - Home .....	62
Advanced - View address .....	62
Advanced - WAP information .....	62
Bookmarks .....	60
Enter address .....	61
Reload page .....	62
Save image .....	61
Service Inbox .....	61
Set as bookmark .....	61
Settings - Push access .....	63
Settings - Security .....	63
Settings - WAP profiles .....	63

## C

Calculator .....	69
Calendar .....	72
Call	
Answering calls .....	10
Ending/rejecting calls .....	10
Making a second call .....	13
Making calls .....	9
Call Barring .....	28
Call Diverts .....	24
Call Duration .....	26
Call log .....	15, 53
Call Waiting .....	25
Calls (Settings) .....	24
Cell Broadcast .....	48
Change PIN .....	27
Change PIN2 .....	27

Chat .....	47
Colour Theme .....	21
Contacts	
Contacts dialling .....	9
Contacts list .....	50
Copy from SIM .....	57
Create new	
MMS .....	37
SMS .....	43

## D

Data connections .....	22
Desktop Handsfree .....	12
Display	
Display (Settings) .....	21
Main display .....	2
Status icons .....	6
Display language .....	22
Download .....	65
DTMF tones .....	12

## E

Earpiece volume .....	12
Emergency call .....	10
Error messages .....	81

## F

Fast Travel Charger .....	2
Fixed Dial .....	28

## G

Games .....	65
Group Settings .....	57
GSM network .....	22

## I

Icons .....	6
Illumination light .....	5
Inbox	
MMS .....	40
SMS .....	44
In-call options .....	12
Incoming call while on a call .....	13
Incoming Tone .....	19, 32
Incoming Volume .....	19, 32
Infrared .....	70
Input language .....	22
Input mode .....	35
International dialling .....	10

## K

Key Backlight .....	21
Key Tone .....	19, 33
Key Volume .....	20, 33
Keyguard .....	30
Keys .....	3, 4

## L

Language .....	22
----------------	----

<b>M</b>			
	Memory status		
	Contacts .....	57	
	Messages .....	48	
	My Media .....	77	
	Menu		
	Displaying menu .....	9	
	Main menu .....	7	
	Menu option .....	7	
	Message Tone .....	19, 32	
	Message Volume .....	19, 33	
	Messages .....	37	
	MMS (Multimedia Messaging Service) .....	37	
	Multi-party call .....	14	
	My Media .....	74	
	My Number .....	56	
<b>N</b>			
	Network setting .....	22	
	New Search .....	22	
<b>P</b>			
	Pause dial .....	12	
	Phone ON/OFF .....	9	
	Pictures (My Media) .....	74	
	PIN entry .....	27	
	Profiles .....	32	
<b>Q</b>			
	Quiet mode .....	11	
<b>R</b>			
	Recent number dialling .....	9	
<b>S</b>			
	SDN (Service Dialling Number) .....	57	
	Search Mode .....	23	
	Security .....	27	
	Select Network .....	22	
	Send my number .....	26	
	Server setting .....	59	
	Service Charge .....	26	
	Service numbers .....	57	
	Settings (Games) .....	66	
	Settings (Messages)		
	MMS .....	42	
	SMS .....	46	
	Settings (Others) .....	19	
	Shift mode .....	34	
	Shortcuts		
	Keypad .....	5	
	My Media .....	76	
	SIM		
	Inserting .....	1	
	Removing .....	1	
	SIM Tool Kit .....	68	
	Slide .....	38	
	SMS (Short Message Service) .....	43	
	Snooze Function .....	69	
	Sound (Settings) .....	19	
	Sound recorder .....	69	
	Sounds (My Media) .....	75	
	Speed dial .....	54	
	Speed Dial list .....	54	
	Standard dialling .....	9	
	STK (SIM Tool Kit) .....	68	
<b>T</b>			
	T9@ .....	35	
	Text entry .....	34	
	Text input .....	35	
	Text templates .....	76	
	Time and date .....	29	
	Tone setting .....	19	
<b>V</b>			
	Vibration Alert .....	20, 33	
	View groups .....	55	
	Voicemail .....	11, 47	
<b>W</b>			
	Wallpaper .....	21	
	Warning Tone .....	20, 33	



The Serial Number can be found on the outside of the phone under the battery. For your convenience we recommend that you note the following details as a record of your purchase.

Part Number	
Serial Number	
Dealer Name	
Purchase Date	