

PHILIPS

INSTRUCTIONS FOR USE

diga[™]



GSM



PHILIPS

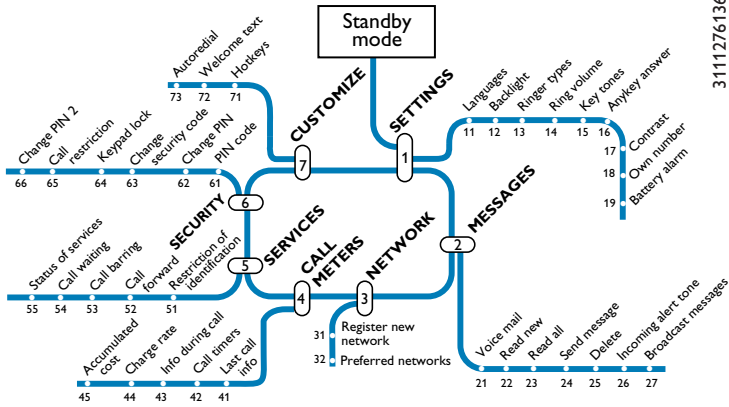

311127613673

digaTM



1 Before you start

9 Basic functions

13 Phone book

19 List of accessories

21 Using the menus

33 Using network services

37 A problem ?

Antenna ring
Fit your favorite colour
antenna ring



Description of the phone

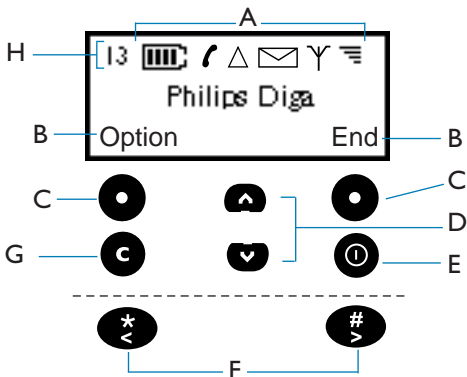

A: Symbols



Battery charge: 4 bars means battery charged.



Telephone: Tel. steady means that a call is in progress. Tel. flashing means that your phone is ringing.



Roaming: means that you are using a network other than your home network.



Mail: mail steady means that you received a new text message. Mail flashing means that the memory is full.



Network: means that the phone is registered with a network.





Reception quality: 4 bars means the best reception.

B & C: Soft keys

The phone has two 'soft keys' (C). The soft keys do different things at different times. A label (B) on the display shows what the soft key will do. In this guide, when we say 'press **End**', what we mean is 'press the soft key under the label **End**'.

D: Scroll keys

Use these keys to 'scroll' through menus, phone book or messages. When it is possible to scroll up and down, the scroll indicators  are shown on the display.

In standby mode, press  to select the Redial list or  to select the Reply list. During a call, use these keys to set the volume.

E: On/Off button

Press and hold to switch the phone on or off.

F: Right and Left keys

Use these keys to move the cursor right or left when you enter a text message. When it is possible to move the cursor,  are shown on the display.

G: Clear key

Use this key to clear the display or delete mistakes you made. Press and hold this key to go back to standby mode from the Menu options.

H: Index

The index displays one, two characters or nothing depending on what you are doing. The indications displayed are as follows: position in the menu or in a list, number of the active call when receiving two calls, 'S' if the silent mode is activated, '*' to indicate the currently selected option.

Radio waves

Your cellular phone is a radio transmitter/receiver. It transmits and receives radio waves in the GSM frequency. The GSM network controls the power at which the phone transmits (between 0.02 watts and 2 watts).

Your cellular phone complies with all relevant safety standards. The CE mark on your cellular phone means that it is compliant with the European directive on electromagnetic compatibility 89/336/EEC and the low voltage directive 73/23/EEC.

Safety precautions

Careless use of the phone can result in harm to you or others. Please read and follow all the security instructions given here and inquire about local laws and regulations.

- **Vehicles:** check with the manufacturer that electronic equipment used in your vehicle will not be affected by radio energy. Avoid using your phone while driving (it affects your concentration). Respect the local laws and regulations.
- **Aircraft:** switch your phone off when in an aircraft. It is illegal to use your cellular phone when airborne.

- **Hospital:** switch your phone off near hospitals or medical equipment. Ask the manufacturer about the radio wave shielding of any electronic medical devices which you may use (pacemakers, hearing aids).
- **Blasting areas:** switch your phone off where blasting is in progress (quarries).
- **Flammable atmospheres:** switch your phone off in areas with a potentially flammable atmosphere (petrol stations, fuel depots or chemical plants).
- **Safety:** use your phone in the normal operating position (to ear). Do not touch the antenna while a call is in progress. Do not use your phone with a damaged antenna (risk of minor skin burn).
- **Children:** keep your phone in a safe place, out of reach of small children.

Using your phone efficiently

To improve the performance of your phone and reduce radio energy emission and battery consumption:

- Avoid low reception areas (tunnels or between tall buildings). If the  shows less than 2 bars, move to another location.

- Always let your battery discharge completely before recharging it.
- Do not use any battery chargers other than those specified in the PHILIPS catalog. Using another charger may be dangerous and will invalidate any approval given to the phone.
- Do not allow metal objects to short circuit the battery contact (such as keys in your pocket).
- Switch the phone off if you are going to leave it unused for a long time.
- Store the phone in a clean, dust free place.
- Keep the phone away from heat.
- Do not try to disassemble the phone. If it is not working properly, call the PHILIPS Helpline.
- Keep the phone dry and do not use harsh chemicals (such as solvents or detergents) to clean it. To clean the phone, wipe it with a soft cloth dampened with a mildly soapy water solution.

The SIM card

To use your phone, you must insert a valid SIM card supplied by your GSM service provider.

When you switch the phone on, it may ask for the PIN code. The PIN code is the secret code of the SIM card. You cannot use the SIM card without the PIN code.

The SIM card contains your subscription number and phone number. It also contains a memory in which you can store phone numbers and messages. If you use your SIM card on another phone, you still retain the same phone number and phone book.

Inserting the SIM card

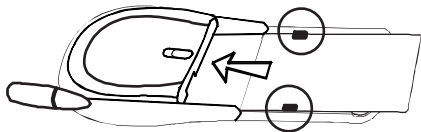

- Remove the battery.



- Slide card into the grooves in the phone (the chip must be facing inwards and towards the bottom of the phone).

The battery

Your phone is powered by a rechargeable battery. Charge the battery after purchase.

Battery charge is shown by the  symbol. Each bar shown represents 25% of charge. If the phone emits a warning signal and the  symbol is shown, you should charge the battery.



Charge a new battery for at least 24 hours before use.



A battery only reaches its maximum capacity after being totally discharged and recharged 2 or 3 times.

A battery lasts longer if you allow it to fully discharge from time to time.

Clipping on the battery

- Hook the battery onto the hinge at the bottom of the phone.

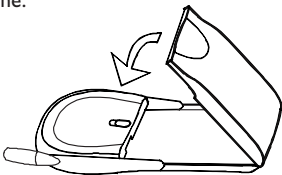

- Swing the battery down and click it into place.

Removing the battery

- Push the latch at the top of the battery.





- Swing the battery up and then lift it off the phone.

Charging the battery

↓ A charger is supplied with the phone.

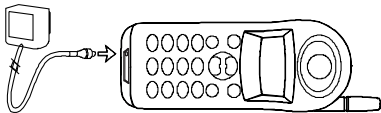
- Clip the battery onto the phone.
- Plug the connector into the round socket at the base of the phone.



- Plug the transformer unit into a mains AC power socket.
- The  symbol indicates the state of the charge process:
 - bars moving - means the battery is charging.
 - steady - means the battery is fully charged.



The only way to turn the charger off is to unplug it.

You can switch the phone on and use it during charging.



The charger can be connected to an IT power supply.

If the battery is completely discharged, the battery icon will only appear 2 to 3 minutes after you connect the charger.

Switching on/off

Press  to switch your phone on.

Type your **PIN code** if activated and press **OK**



If you enter the wrong **PIN code** 3 times, your SIM card will be blocked.



You must then enter the PUK code provided by your service provider (10 wrong PUK codes entered will totally block your SIM card. Contact your service provider).

Press and hold  to switch your phone off.

Standby mode

After being switched on, your phone goes to standby mode. Your phone is ready to use. The display is as follows:

network to which you are connected

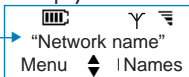

battery charge status (max. : 4 bars).





your phone is registered with a network.





quality of reception (max. : 4 bars).



If the  and the  are not displayed, the network is not currently available. Move to a different location.



In this guide: operations started from standby mode are marked . Operations started during a call are marked .



Making a call

- Dial the phone number you require.
- Press **Call**,
During the call  is displayed.
- Press **End** to end the call.



Answering a call

When a call is received: the phone rings,  flashes and the display shows **Ringing** or caller number if your network supports this service.

- To reject the call, press **Reject**

If you reject the call, the phone returns to standby mode and the caller hears the busy tone.





The rejected call may be forwarded to another number (see Using the menus/Call forward in page 27).

- To answer the call press **Answer**,  is displayed.
- Press **End** to end the call.



Earpiece volume

- Press   to adjust the earpiece volume.



The display shows 1 to 5 black rectangles to indicate the volume level (maximum volume = 5 black rectangles).



Redialling

You can recall the last 10 different numbers dialled.

- Press to display the **Redial list**. The last number you dialled is displayed.
- Press and select another phone number.
- Press **Call**



Replying

You can recall any of the last 10 different numbers that called you (if your network supports this service).

- Press to display the **Reply list**, the last number that called you is displayed.
- Press to select another phone number.
- Press **Call**



Switching the microphone off/on

- Press and hold **Option** or to switch the microphone off. **Muted** is displayed.



When receiving two calls, the left soft key label is **Switch** instead of **Option**.

- Press **Unmute** to switch the microphone on.

Emergency Call

You can make an emergency call without entering your PIN code.

- Switch your phone on.
- Press **SOS**. The display shows **Emergency**.
- Press **Call**

*You can also make an emergency call from the standby mode by entering 112 and pressing **Call**.*





Depending on your network, you can make an emergency call with no SIM card in your phone.



Using the Hot Keys

Your phone is provided with functions directly accessible in standby mode. Pressing and holding any numeric key of the keypad (1 to 9) activates one of these functions (**Hot Keys**).

Reminder: in standby mode, the numeric keys are pressed normally to dial a phone number.

- Make sure your phone is in **standby mode** (the network's name is displayed).
- Press and hold a key between  and  to activate the associated function.



*You can visualise and modify the initial settings of the **Hot Keys** (see Using the menus/Customize in page 29).*

Lists

The electronic phone book contains 3 separate lists:

- **Names list**

When you create a phone book entry (a name and a phone number), it is recorded in the Names list. The maximum number of entries depends on your SIM card.

- **Redial list**



Every time you make a call, the phone number is recorded in the Redial list. The last 10 different numbers are saved.

- **Reply list**

Every time you receive a call, the phone number is recorded in the Reply list (if your Network supports this service). The last 10 different numbers are saved.



Making an entry in the Names list

- Dial the phone number.
- Press **Store**
- Enter a name with the keypad (see Entering a name in page 14).
- Press **OK** to confirm the name.
- Press **OK** to confirm the phone number.
- Press   to set the position of the entry. This position is displayed in the index.

- Press **OK** to save the entry.



When the SIM card memory is full, you must delete an entry before you can add another (see Deleting from the Names list in page 18).

Entering a name

Each key corresponds to several characters.







Key	Upper case	Lower case
1	[space]1.,"!;';)&@	[space]1.,"!;';)&@
2	ABC2AÄÅÆÇ	abc2àáâäæç
3	DEF3ÉÊËΔΦ	def3éêëΔΦ
4	GHI4ΓΙ	ghi4Γι
5	JKL5Λ	jkl5Λ
6	MNO6ÑÒÖØ	mno6ñõöø
7	PQRSβΠΘΣ7	pqrs7βπθσ
8	TUV8Üù	tuv8üù
9	WXYZ9ΩΞΨ	wxyz9ΩΞΨ
0	0+*/-.%<>=#£\$¥ §	0+*/-.%<>=#£\$¥ §

Press a key several times to select the character you want. For example:





- Press  3 times to enter the letter **C**.



If the next character uses the same key as the precedent, wait 2 seconds or move the cursor right.

- Press  or  to move the cursor left or right.
- Press  to enter a space.
- Press  to change between upper and lower case.
- Press  to delete one character.
- Press and hold  to delete the whole line of characters.

Entering a number

- 
- Enter numbers using the keypad.
 - Press and hold  to enter + instead of the international prefix.
 - Press  to delete one character.
 - Press and hold  to delete the whole line of characters.



All numbers should be entered in their international format. This means that you can dial all numbers from any network.



Making a call from the Names list

You can select an entry from the Names list and dial it directly.

- Press **Names** then **OK** (or simply press and hold **Names**) to select the Names list.
- Press  to select the required entry.
- Press **Call**
- Press **End** to end your call.



Searching for a name

You can use a short cut to recall an entry from the Names list.



- Press **Names**
- Enter the first letter(s) of the name you require.
- Press **Search**
- The display shows the first name which begins with the letter(s) you entered.
- Press **Call**



Changing an entry

You can change the name, number or position of an entry in the Names list.





- Press **Names** then **OK** (or simply press and hold **Names**).

- Press  to select the required entry.
- Press **Option** then **OK**
- Change the name using the keypad, then press **OK**
- Change the number using the keypad, then press **OK**
- Change the position using 
- Press **OK** if the new position is free or **Swap** if the new position is in use.



Copying an entry into the Names list



You can copy a number from the Redial or Reply list into the Names list.

- Press  to copy from the Reply list or  from the Redial list.
- Press  to show the number you want to copy.
- Press **Option**
- Press  to select **Store**
- Press **OK**
- Enter a name with the keypad and press **OK**

- Press **OK** to confirm the phone number.
- Press  to set the position of the entry.
- Press **OK** if the new position is free or **Swap** if the new position is in use.







Deleting from the Names list

- Press **Names** then **OK** (or simply press and hold **Names**)
- Press  to select the required entry.
- Press **Option** then  . **Delete** is displayed.
- Press **OK** then **Yes** to confirm the deletion.



Deleting from the Reply and Redial lists

- Press  to delete an entry from the Reply list or  to delete an entry from the Redial list.
- Press  to select the number you want to delete.
- Press **Option**
- Press  to show **Delete** to delete one phone number from the list or **Delete all** to delete all phone numbers from the list.
- Press **OK**

3 different batteries

BHR 155/P	600 mAh NiMH Standard pack
BHR 156/P	600 mAh NiMH Slim pack
BHR 159/P	900 mAh NiMH Business pack

Fast Charger Powers phone and charges battery in a short time.

European plug	ACSR15/P	UK plug	ACUR15/P
Australian plug	ACAR15/P	USA plug	ACTR15/P
South Afr. plug	ACZR15/P		

Carry cases	Green	PBMR/15P	Yellow	PBYR15/P	
Red	PBRR/15P	Blue	PBHR/15P	Black	PBBR15/P
Brown	PBNR/15P	Grey	PBGR/15P	Bordeaux	PBPR15/P

Cigarette Lighter Adaptor (CLA) Powers phone and charges battery in a car.

Car Kits Two different kits are available, very easy to install:

- | | |
|----------|--|
| CKBE/10P | • Basic Car Kit includes a phone holder and CLA. |
| CKEE/10P | • Easy handsfree Car Kit: minimum of installation for a handsfree solution |

*availability depending on countries.

DeskTop Charger

DTBE 10/P

Charges a battery when connected to the phone and provides a slot for an accessory battery.

Handsfree Headset

HSAE10/P

Combining an ergonomic earpiece and a microphone to use your phone in every situation (walking, riding a bicycle, etc...).

Slider

- Provides protection against accidental keypad use.
- It is not necessary to open it to receive calls.
- It is not necessary to open it to place calls from the Names list, Redial or Reply lists.
- It can be detached by the user. The functionality of the phone remains the same.

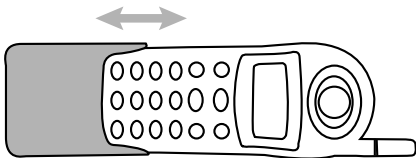

Your phone has a set of functions arranged in menus and submenus. The menu system makes it easy for you to access the phone functions.



How to navigate

■ Press **Menu**

■ Press  to display one of the 7 menus.

■ Press **OK** to select the menu.

■ Press  to scroll through the different submenus.

■ Press **OK** to select a submenu.

■ Press **Exit** or  to return to the previous display.

■ Press and hold  or **Exit** to leave the menu system and return to standby mode.



Short cuts into menus and submenus

Each menu or submenu has a number which is displayed in the index. Use the menu or submenu numbers for quick access to a menu.

■ Press **Menu**

■ Enter the menu or submenu number.

■ Press **OK** to select the menu or submenu.

Settings menu (1)

Use the Settings menu to personalise your phone.

Languages (11)

Set the language of your phone.

Backlight (12)

Switch on/off the backlight function. If selected on, the keypad and display will light up for 15 seconds each time you press a key.

Ringer types (13)

Set your preferred melody (8 choices).

Ring volume (14)

Set the volume of the ring tone (3 levels plus silent mode).

Key tones (15)

Switch on/off the tones you hear when you press a key.

Anykey answer (16)

Switch on/off the function for accepting a call by pressing any key of the keypad.

Contrast (17)

Set the display contrast level (5 levels).

Own number (18)

Display your phone number.



It needs to be entered first.

Battery alarm (19)

Switch on/off the signal which warns that the battery needs charging.

Messages menu (2)

Use the messages menu to handle your voice and text messages. **Voice messages** are stored in a mailbox by the network. **Text messages** are automatically received by your phone. If somebody sends you a message while your phone is off, you will receive it when you switch your phone on (except for broadcast messages).

Receiving a text message:

Your phone emits a beep (if Incoming alert tone (26) is activated),  is displayed and the text message is stored in the Saved list.



If  flashes, the Saved list is full and you must delete some text messages.

Voice mail (21)

- **Mail box:** shows your mail box number if you have entered it in **Box number**. Press **Call** to call your mailbox. You can also use the Hotkey 1 to call your Mail Box (see Basic functions/Using the Hotkeys in page 12).
- **Box number:** enter or modify your voice mailbox number. The box number must be entered to use Hotkey 1.

Read new (22)

Use this function to read or delete a new text message.

Read all (23)



Use this function to read or delete all text messages saved in the saved list.

Send message (24)

Write and send text messages



- Enter your message using the keypad then press **OK**
- Enter the phone number to be called or press **Names** to select it in the Names list, then press **OK**
- Enter the number of the Message centre or press **Names** to select it in the Names list, then press **OK**
- Press **OK** to send the message immediately (it can be saved later) or press  then **OK** to save your message in the Saved list (the message can be sent later).
- Press **Exit** to quit.

Reply to a saved incoming text message

- Press **List**.
- Press  to select **Saved list** then **OK**.
 - Press  to select an incoming text message.
- Press **Reply**.

- Enter the number of the Message centre or press **Names** to select it in the Names list, then press **OK**
- **Send** is displayed. Press **OK**
- Press **OK** to save your answer in the Saved list or press **Exit** to quit.

Send a message from a list

- Press **List**
- Press  to select Saved list or Standard list then press **OK**
- Press  to select a message then press **OK**
- Enter the phone number to be called then press **OK** or press **Names** to select an entry in the Names List.
- Enter the number of the Message centre or press **Names** to select it in the Names list, then press **OK**
- Press **OK** to send, then press **Exit**



The Standard list contains standard messages that are provided with the phone.

Delete (25)

Use this function to delete messages from the Saved List.

Incoming alert tone (26)

Switch on/off the alert tone when a message is received.

Broadcast messages (27)

Switch on/off the function for receiving all broadcast messages.



Cell Broadcast messages are sent by the network to all connected GSM phones (e.g.: weather reports). This option will appear in menu depending if the network provider offers this service. If you activate this function, the standby time of the phone will be reduced considerably (appr. 30% less).

Network menu (3)

Use the Network menu to manage network connections.

Register new network (31)

Use this function to register with another available network.



A # before a network name indicates that this network is forbidden.

Preferred networks (32)

Use this function to create and manage a list of your preferred networks. When you switch your phone on and several networks are available, your phone will select one according to this list.

Call meters menu (4)

Use the Call meters menu to show the cost or the duration of calls.

Last call info (41)

Switch on/off the display of call duration and call cost after each call.

Call timers (42)

Use this function to display the total duration for Outgoing, Incoming and Life time calls. Use the **Reset** function to reset the Outgoing and Incoming calls meters to zero. The reset function requires the security code (see page 29).



When you are registered with a network other than your home network, you are said to be 'roaming'. Δ is displayed. Lifetime calls meter cannot be reset.

Info during call (43)

Switch on/off the display of call cost or call duration during each call.



Access to the two following submenus (44) and (45) requires a PIN2 code and a phase 2 SIM card (see your service provider).

Charge rate (44)

Use this function to enter the currency unit and the charge rate (cost of a call per unit of time).

Accumulated cost (45)

Display, set and reset the accumulated cost limit. Display and reset the current accumulated cost.

Services menu (5)

Use the Services menu to activate Network services provided by the GSM network. The availability of these functions depends on the network services you have subscribed to.

Restriction of identification (51)

Switch on/off the function for sending your phone number to your correspondent.

Call forward (52)

Divert incoming calls to another number of your choice.

You can forward different types of incoming calls:

- all calls,
- calls when your phone is busy,
- calls which you did not answer,
- calls received when a network cannot reach you.

Call barring (53)

Barring of incoming calls or outgoing calls.



These functions require the call barring password provided by your service provider.

Call waiting (54)

Switch on/off the call waiting service (see Using Network Services in page 31).

Status of services (55)

Show the currently selected network services on the phone display.



This function calls the network. You may be charged for it. Check with your network provider.

Security menu (6)

Use the Security menu to protect your phone against unauthorised use.

PIN code (61)

Switch on/off the requirement to enter your PIN code at switch on.

Change PIN (62)

Use this function to change your PIN code.



Options 62 only appears if PIN code is activated.

Change security code (63)

Use this function to change your security code.



When you buy your phone, the security code is 1234.

Keypad lock (64)

Use this function to prevent accidental activation of the keys (for example, when the phone is in your pocket).



Press and hold **Unlock** to unlock the keypad.

Call restriction (65)

Use this function to restrict calls to numbers on the Names list and/or restrict the length of permitted phone numbers.

This function requires the security code.









Change PIN2 (66)

Use this function to change your PIN2 code. Access to this submenu requires phase 2 SIM card.



Customize (7)

Hot Keys (71)

Your telephone is provided with 9 Hot Keys (keys 1 to 9) that allow you to perform the features you use more frequently by simply long-pressing on one key. The function of these keys is programmable by the user. Bellow is list of the factory-default programmed functions for the Hot Keys.

Long press on key	Function
	Call Voice Mail
	Keypad Lock activation
	Toggle Silent Ringer
	Status of services request
	Toggle security PIN lock
	Read New message
	Redial last called number
	Reply to last incoming call (if available in the network)
	Read all messages

To visualise the current settings of the Hot Keys

- Press   to visualise the setting for each of the keys (the number of the current key is displayed in the index).

To modify a Hot Key setting

- Press **Change**



Not available for key 1 which is not reprogrammable (set on Call Voice Mail).

- Press   to select a new function, then **OK**



Select **Clear HotKey** to cancel a hotkey setting.

The functions for which you can attribute to hotkeys are the following:

Emergency call	Read all	Read new
Flash dial™	Send message	Call forward
Redial last number	Silent ringer	Status of services
Reply to last call	Keypad lock	PIN code on/off

According to the selected function, you must enter more details:

- Flash dial™: select a name in the Names list. You can make a call to the selected name by simply pressing and holding the hotkey.

- **Send message:** select a message in the Saved list. You can send again a saved message to the same number you originally sent it to.
- **Call forward:** select function as in **Call forward** menu then enter a phone number or select a name in the Names list.



Some Hot Keys may be locked depending on the network.

Welcome text (72)

Use this function to change the welcome message displayed when you switch the phone on.

- Press and hold **C** to delete the old message.
- Enter the new welcome message using the keypad.

Autoredial (73)

Switch on/off the **Autoredial** function.

- If the number you call is busy, the display shows **User busy**. Press **Redial**, your phone will automatically try to make the call again a few second later.
- If the called number is still busy, it will try again, up to 10 times. When the called line becomes connected, the phone emits a series of alert beeps.
- Press **Exit** to cancel the Autoredial function.

The availability of the following functions (except for DTMF tones) depends on the network services you subscribed to. To use the following functions, make sure **Call waiting (54)** is switched on (see Using the menus/Call waiting (54) in page 28).



Putting a call on hold

Putting an active call on hold is useful if you receive a second call or if you want to make a second call during the active call.

- Press **Option**
- Press  to select **Hold**.
- Press **OK**. **On hold** is displayed. The call is on hold.
- Press **Return** to reactivate the call.



Answering a second call

When you receive a second call, **Call waiting** or Caller phone number is displayed and the phone emits a call waiting tone.

- Press **Answer** to answer a second call.
The first call is put on hold. The second call becomes active. The active call is displayed in the index (1 or 2).

- Press **Switch** to switch between the two calls.
The active call is displayed in the index (1 or 2).
- Press **End** to end the active call, **on hold** is displayed.
- Press **Return** to reactivate the call on hold.



Answering a third call

If you receive a third call during an active call with a call on hold, the display shows **Call waiting** and you hear a waiting tone. You must end one of the calls before answering.

- Press **Switch** to select the call you want to end.
- Press **End**
- Press **Answer** to answer the call or **Reject** to ignore it.

During several calls the display shows:

- **Call 1,2** or **3** depending on the selected active call,
- the phone number of the caller (if your network supports this service) or the phone number you called (if it is an outgoing call).
- or the name of the caller or called person if the phone number is stored in the Names list.



Making a second call

You can make a second call during an active call or during a call on hold.

- Dial a number and press **Send**.
- Or press **Option** and  to select the number from the Names list, Redial list or Reply list (see Phone Book in page 13).
- Press **Switch** to switch between the two calls.
- Press **End** to end the active call. **On hold** is displayed.
- Press **Return** to reactivate the call on hold.

DTMF tones

The numeric keys of the phone (0 to 9, * and #) always transmit DTMF tones (Dual Tone MultiFrequency) also known as “touch tones”. DTMF tones are used by certain telephone services such as answering machines, pagers, etc.

Rather than keying in a separate code after each of a series of requests, you can carry out complex operations in one go.

e.g. To reach 'Listen to new messages' in one go

An answering machine has the following characteristics: phone number 12345, password 9876, code 3 to activate the function 'Listen to new messages'.

- Enter 12345, **12345** is displayed.
- Press and hold ***<** to enter a wait character. **12345w** is displayed.
- Enter 9876, **12345w9876** is displayed.
- Press and hold ***>** to enter a pause character, **12345w9876p** is displayed.
- Enter 3 and press **Call**, **12345w9876p3** is displayed.

This DTMF sequence can also be stored in the Phone book.



Your phone always interprets the first pause as a wait character (the rest of the digits are not sent until your phone is connected). The second pause is a real pause of 2.5 seconds. To get a longer pause enter several pause characters.



Trouble Shooting

Problem

Solution

The display shows **BLOCKED** when you switch on.

Somebody tried to use your phone but didn't know the PIN code or Unblocking code. Contact your service provider.

The  and  symbols are not showing.

The network connection is lost. Either you are in a radio shadow (in a tunnel or between tall buildings) or you are outside of the network coverage area. Try from another place.

The display doesn't respond (or responds slowly) to key pushes.

The display responds more slowly at very low temperatures. This is normal and does not affect the operation of the phone. Take the phone to a warmer place and try again.

Your phone does not go to standby mode.

- Either press and hold 
- Or switch off the phone, check that the SIM card and battery are installed correctly, and switch on again.